



HOUSE OF TROY



Illuminate your life with House of Troy



HOUSE OF TROY

Celebrating 75 years

Tucked into the northern Vermont hills, just down the road from the picturesque ski village of Stowe, House of Troy has been producing classic lighting since 1947. Though off the beaten path and far from the spotlights of the big cities, our reputation burns brightly. House of Troy is proud to offer lighting known for its craftsmanship and quality.

We began as metal workers, making products to illuminate fine art work. Over the years we expanded our line to include floor lamps, table lamps and wall lamps. We design our products around a light source creating fine task lamps which suit a need.

In 2013 we purchased Scatchard Stoneware and opened our pottery in Hyde Park, Vermont. Using a high fire reduction process and proprietary glazes, we now offer decorative lamps with beautiful deep finishes that will stand the test of time.

Table of Contents



Picture Lights:
Plug-In
page 5 



Picture Lights:
Direct Wire
page 30 



Picture Lights:
Battery Operated
page 72 

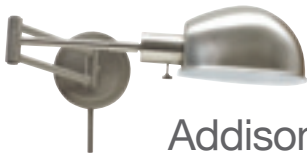

Addison
page 78



Alpine
page 82 



Andover
page 86



Aria
page 88 



Averill
page 92 



Barton
page 94 



Brandon
page 96



Bryson
page 99 



Cavendish
page 102 



Club
page 105



Coach
page 112



Crown Point
page 117

Table of Contents



Delta
page 120 



Fairfax
page 124



Farmhouse
page 126 



Franklin
page 128



Fusion
page 131 



Generation 1
page 134 



Generation 2
page 136 



Generation 3
page 139 

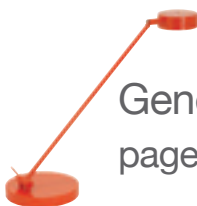

Generation 4
page 143 

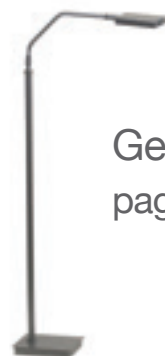

Generation 5
page 150 



Geo Mini
page 152 



Home Office
page 157

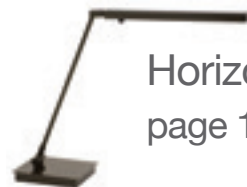

Horizon
page 165 



Hyde Park
page 167 



Jay
page 174 



Killington
page 177



Kirby
page 182 

Table of Contents



Lancaster
page 188

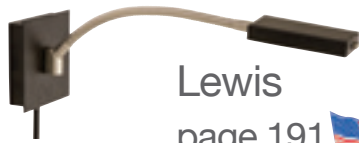

Lewis
page 191 



Logan
page 192 



Morgan
page 196

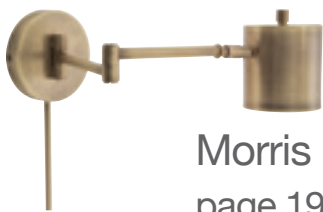

Morris
page 197 



Newbury
page 201 



Newport
page 204



Norton
page 212 



Orwell
page 216 



Otis
page 219



Pinnacle
page 224 



Randolph
page 228



Richmond
page 233



River North
page 235 



Rupert
page 239 



Sawyer
page 244 

Table of Contents



Studio
page 247



Taylor
page 249



Town House
page 251



Tripod
page 257



Uptown
page 258



Vergennes
page 261



Vernon

page 262

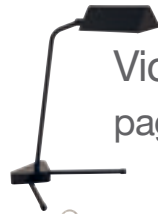

Victory

page 265



Wall Sconces

page 269



Wall Swing Arms

page 280



Windsor

page 294



Wolcott

page 297



Desk/Piano

page 299



Specialty

Desk/Piano

page 314



Specialty Task

page 330



Scatchard Stoneware

page 333



Custom Direct Mount . . .374

Finishes377

Stoneware Glazes379

Q&A381

Index382

Picture Lights — Plug-In



ZEDZ12-52 (*Satin Nickel*)

Plug-In picture lights work best when you have easy access to an outlet. They come with an 8' ivory cord equipped with a high-low roll switch conveniently located 3' from the plug end. If you are planning construction, have your contractor install recessed outlets behind the art work and remotely switch on the wall with a dimmer system. This will create the perfect ambience.

Plug-In Advent Incandescent



A7-71 (Antique Brass)

Features

- Swivel at shade for easy shade positioning
- Slide arm adjusts for horizontal extension
- Paintable 8' ivory cord with In-line hi-lo switch 3' from plug
- Polished metal reflector in shade for maximum light output
- Mount to frame or wall with included hardware

Size Selection Guide

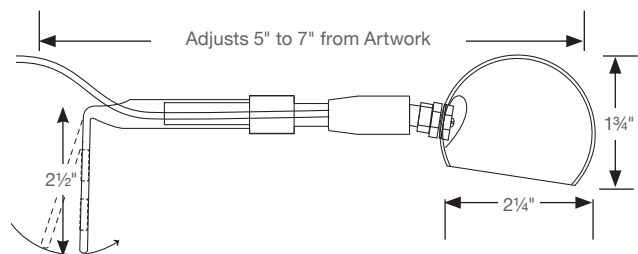
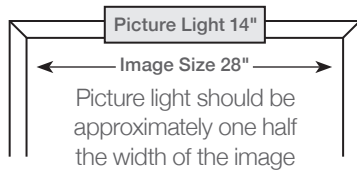

Finishes

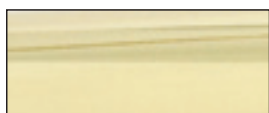

Polished Brass #61

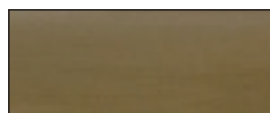

Antique Brass #71

Product Options:

- A7-61
- A7-671
- A14-61
- A14-71

Specifications

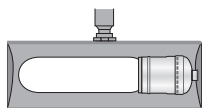

A7" shade
one 25T10F bulb

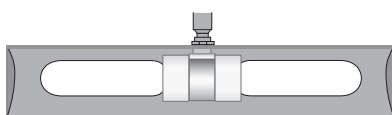

A14" shade
two 25T10F bulbs

Plug-In Advent Profile Incandescent



APR16-61 (Polished Brass)

Features

- Shade rotates to adjust light
- Removable shade for easy bulb replacement
- Paintable 8' ivory cord with In-line hi-lo switch 3' from plug
- Polished metal reflector in shade for maximum light output
- Mount to frame or wall with included hardware
- Optional LED bulbs available (LED 2.5W)

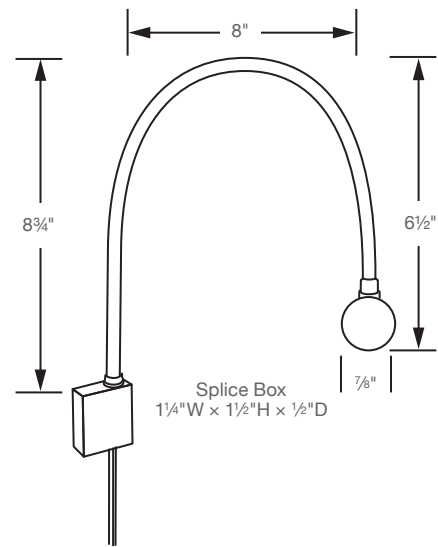

Size Selection Guide

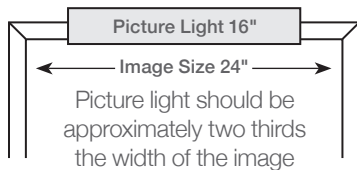

Finishes

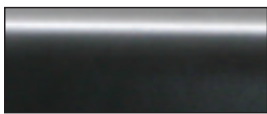

Black #7



Satin Nickel #52



Polished Brass #61

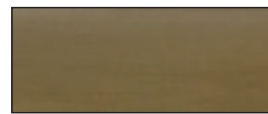

Antique Brass #71

Product Options:

APR16-7
APR16-52
APR16-61
APR-71

Specifications



APR16" shade
 two 15T4 bulbs included

Plug-In Contemporary Incandescent



C9-52 (Satin Nickel)

Finishes



Gold #1

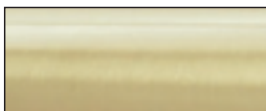

Satin Brass #51



Satin Nickel #52



Polished Brass #61



Chrome #62

Plug-In Contemporary Incandescent

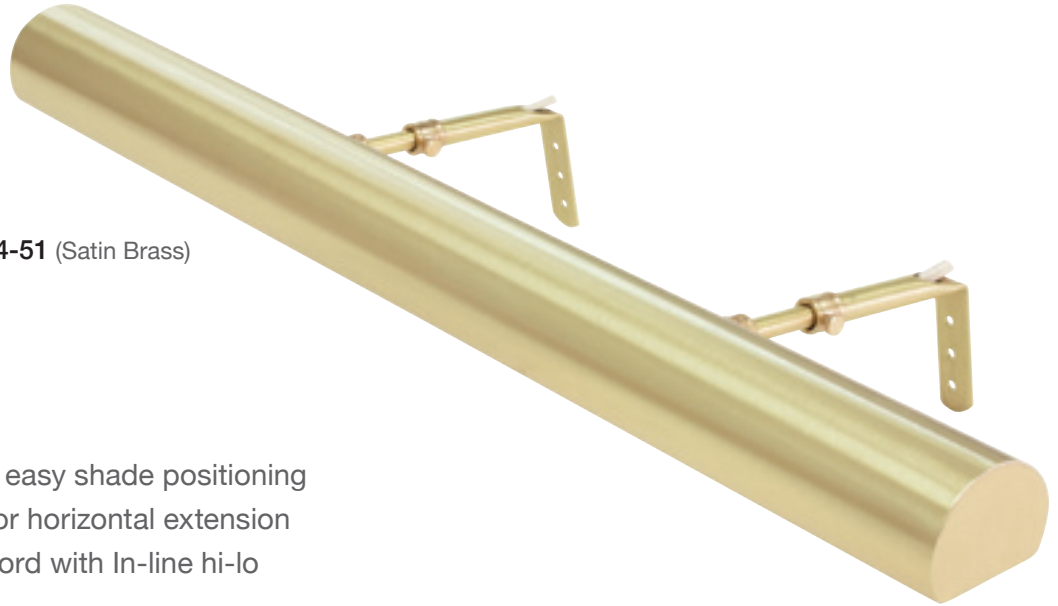

C24-51 (Satin Brass)

Features

- Swivel at shade for easy shade positioning
- Slide arm adjusts for horizontal extension
- Paintable 8' ivory cord with In-line hi-lo switch 3' from plug
- Polished metal reflector in shade for maximum light output
- Mount to frame or wall with included hardware
- Optional LED bulb available
- Customization available upon request

Size Selection Guide

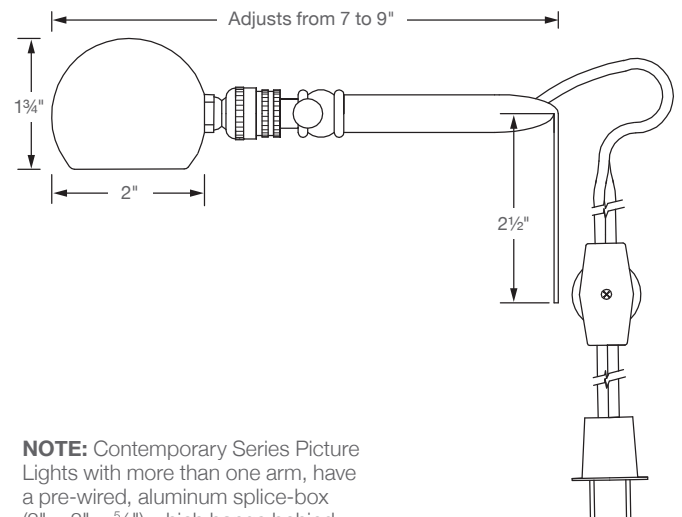
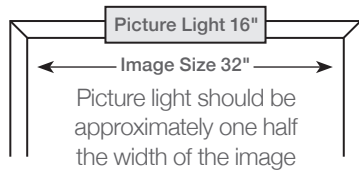

Specifications

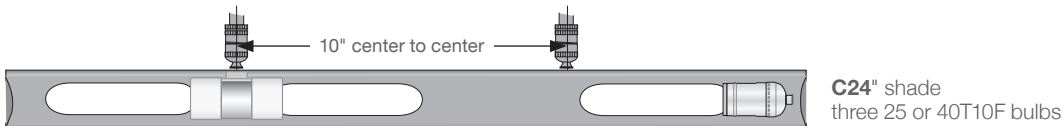

NOTE: Contemporary Series Picture Lights with more than one arm, have a pre-wired, aluminum splice-box (2" x 2" x 5/8") which hangs behind the artwork.

When ordering a Contemporary picture light note C then the shade size followed by the finish code.

Plug-In Hyde Park Incandescent



Features

- Swivel at shade for easy shade positioning
- Paintable 8' ivory cord with In-line hi-lo switch 3' from plug
- Polished metal reflector in shade for maximum light output
- Mount to frame or wall with included hardware
- Optional LED bulb available
- Customization available upon request

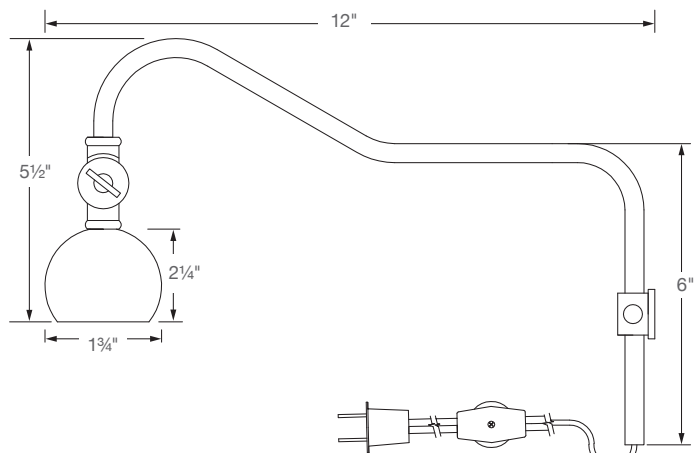

Note: Hyde Park Series Picture Lights with more than one arm, have a pre-wired, aluminum splice-box (2" x 2" x 5/8") which hangs behind the artwork.

When ordering a Hyde Park picture light note HP then the shade size followed by the finish code.

Size Selection Guide

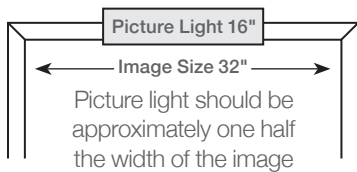

Finishes



Polished Brass #61

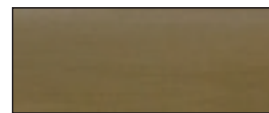

Antique Brass #71

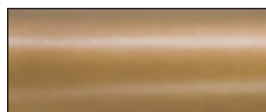

Weathered Brass #76

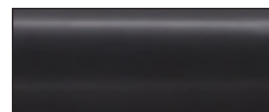

Oil Rubbed Bronze #91

Specifications

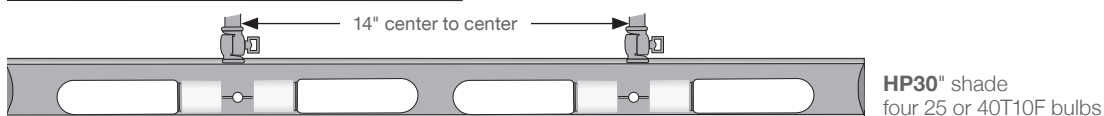

Plug-In Richardson Incandescent

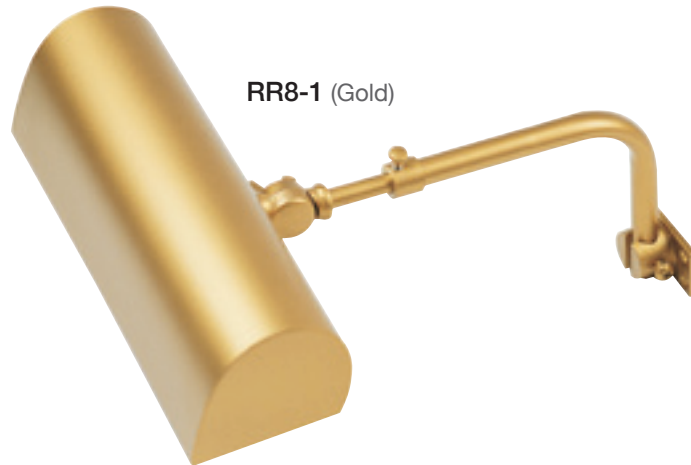

RR8-1 (Gold)

Features

- Swivel at shade for easy shade positioning
- Slide arm adjusts for horizontal extension
- Paintable 8' ivory cord – no inline switch
- Polished metal reflector in shade for maximum light output
- Mount to frame or wall with included hardware
- Optional LED bulb available

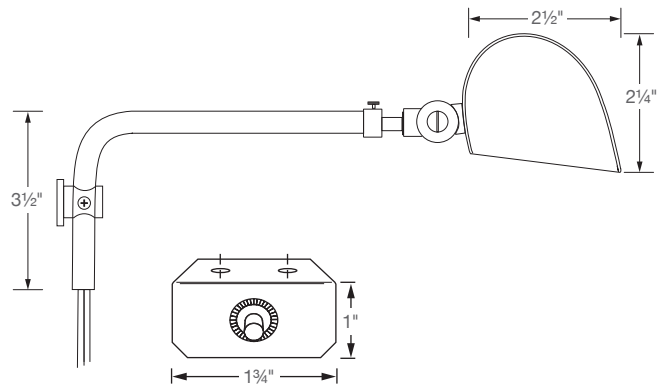

Optional: Richardson
FRAME SWITCH (FRSW)

Type "D" Switch, attaches to back of frame (switch sold separately).

Size Selection Guide

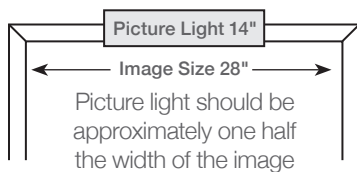

Specifications

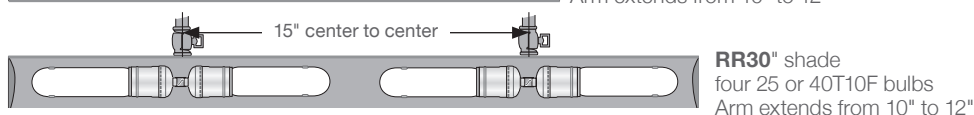
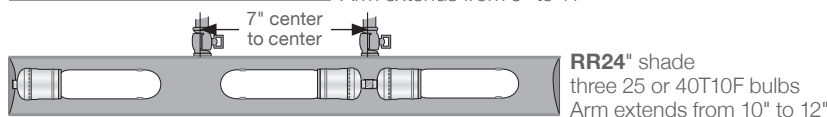
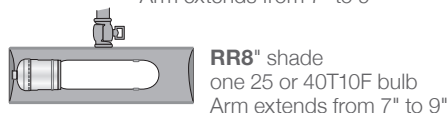
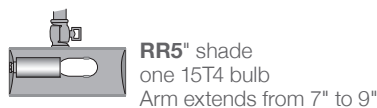

NOTE: Richardson Reflector Series Picture Lights with more than one arm, have a pre-wired, aluminum splice-box (2" x 2" x 5/8") which hangs behind the artwork.

When ordering the Richardson picture light note R then the shade size followed by the finish code.

Finishes

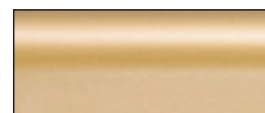

Gold #1

Plug-In Slim-Line™ Incandescent

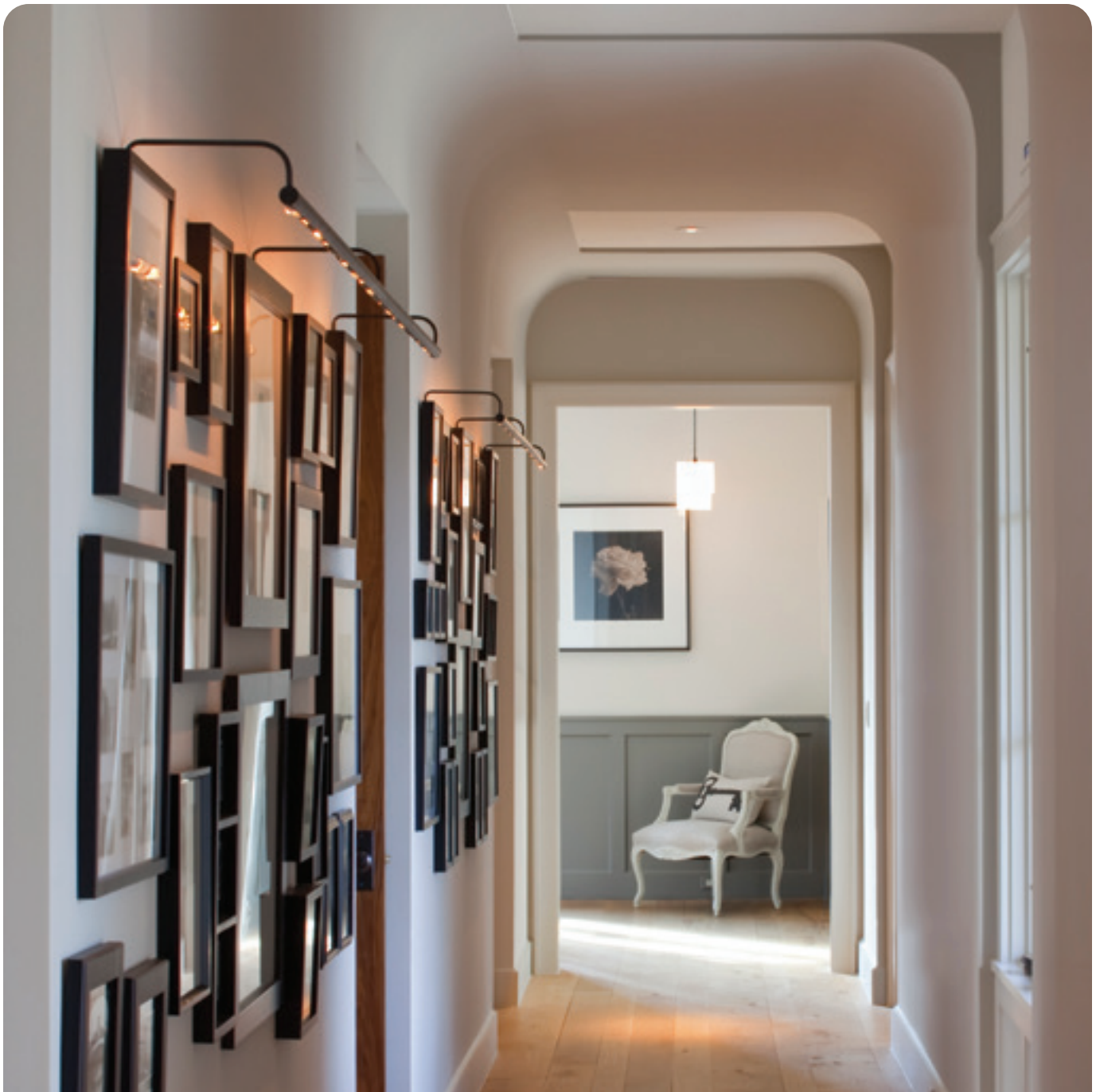

Tim Cuppett Architecture + Interiors

SL64-91 (*Oil Rubbed Bronze*)

Finishes

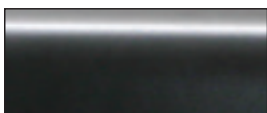

Black #7

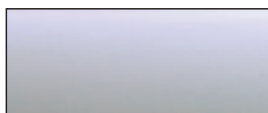

White #9

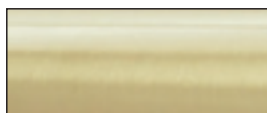

Satin Brass #51

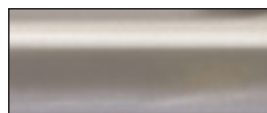

Satin Nickel #52

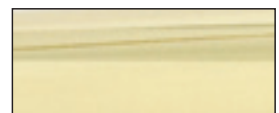

Polished Brass #61



Chrome #62

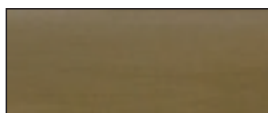

Antique Brass #71



Weathered Brass #76



Oil Rubbed Bronze #91

Plug-In Slim-Line™ Incandescent

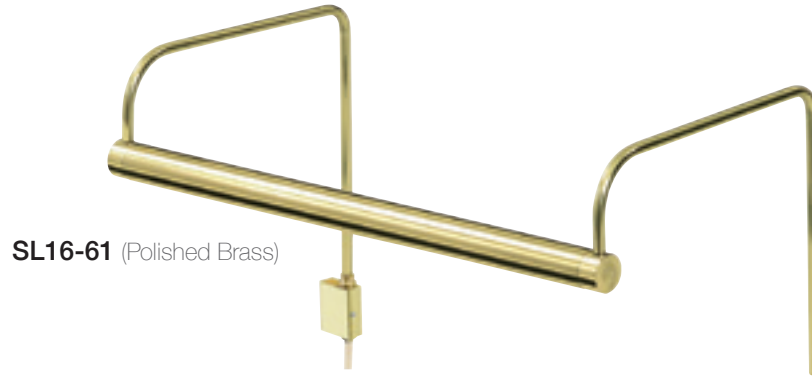

SL16-61 (Polished Brass)

Features

- Shade rotates to adjust light
- Tilt socket allows for easy bulb replacement
- Pebbled aluminum reflector provides maximum light output
- Paintable 8' ivory cord with In-line hi-lo switch 3' from plug
- Mount to frame or wall with included hardware
- Customization available upon request
- Optional LED bulbs available (LED 2.5W)

Size Selection Guide

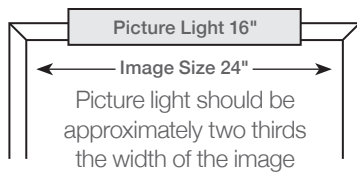

Specifications

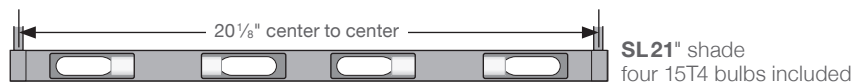
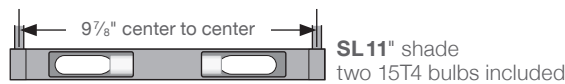
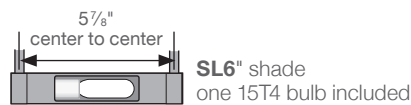

Non stocked lamps available with three arms in 64" and 84" lengths.

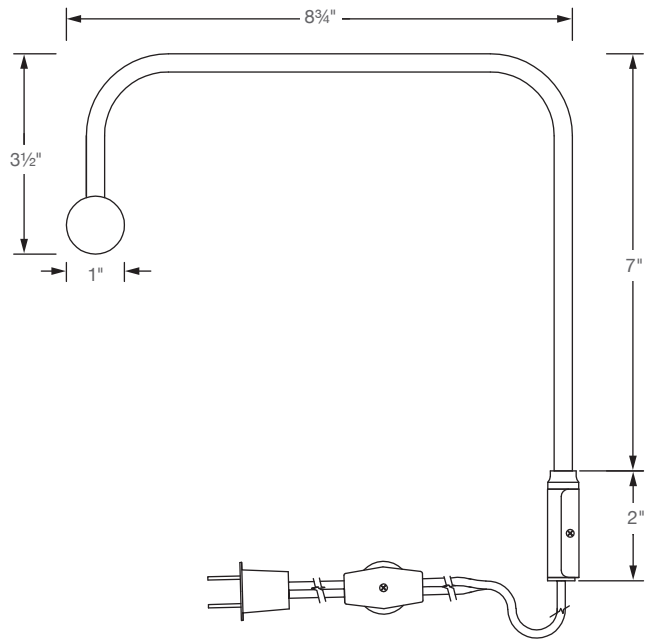

NOTE: When ordering the Slim-Line™ picture light note SL then the shade size followed by the finish code.

Plug-In Slim-Line™ XL Incandescent



XL14-91 (*Oil Rubbed Bronze*)

Finishes

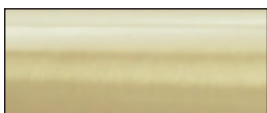

Satin Brass #51



Satin Nickel #52

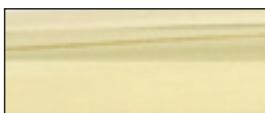

Polished Brass #61

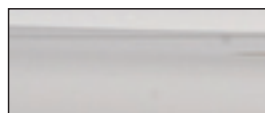

Chrome #62

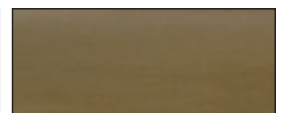

Antique Brass #71



Oil Rubbed Bronze #91

Plug-In Slim-Line™ XL Incandescent



XL36-52 (Satin Nickel)

Features

- Shade rotates to adjust light
- Tilt socket allows for easy bulb replacement
- Pebbled aluminum reflector provides maximum light output
- Paintable 8' ivory cord with In-line hi-lo switch 3' from plug
- Mount to frame or wall with included hardware
- Customization available upon request
- Optional LED bulbs available (LED 2.5W)

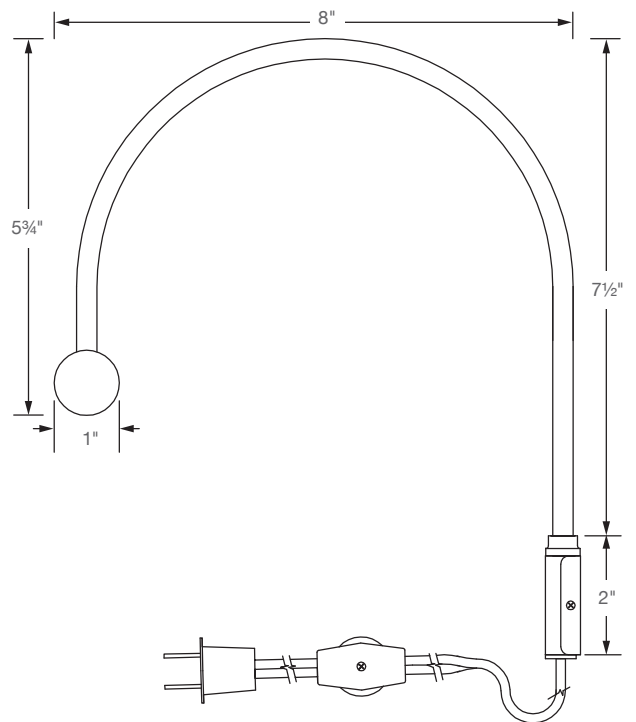

Size Selection Guide

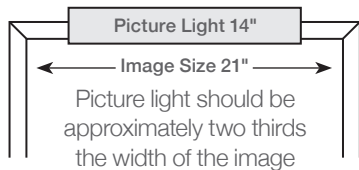

Specifications

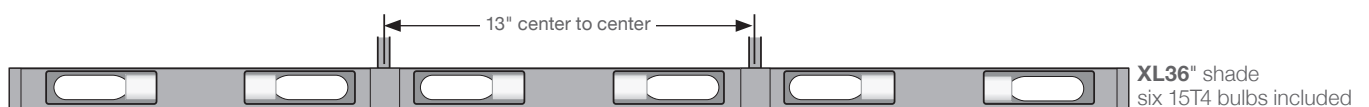

NOTE: When ordering a Slim-Line™ XL picture light note XL then the shade size followed by the finish code.

Plug-In Traditional Incandescent

T36-52 (Satin Nickel)



T14-31 (Pewter)

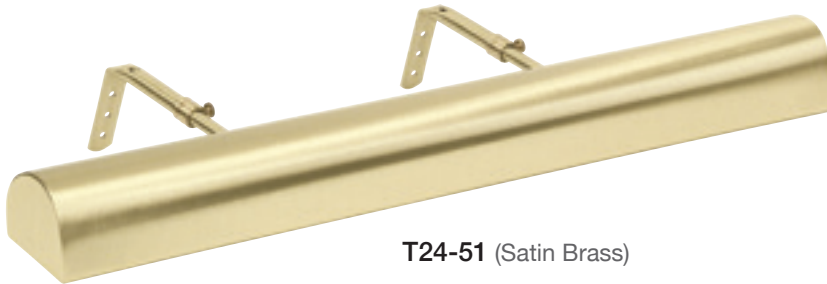

T24-51 (Satin Brass)



T8-1 (Gold)

Standard Finishes



Gold #1



Bronze #5

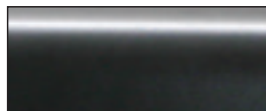

Black #7



Pewter #31



Satin Brass #51



Satin Nickel #52



Statuary Bronze #56



Polished Brass #61

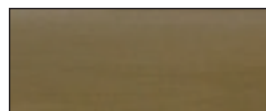

Antique Brass #71

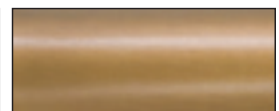

Weathered Brass #76



Mahogany Bronze #81

Plug-In Traditional Incandescent

Features

- Swivel at shade for easy shade positioning
- Slide arm adjusts for horizontal extension
- Paintable 8' ivory cord with In-line hi-lo switch 3' from plug
- Polished metal reflector in shade for maximum light output
- Mount to frame or wall with included hardware
- Optional LED bulb available
- Customization available upon request

Size Selection Guide

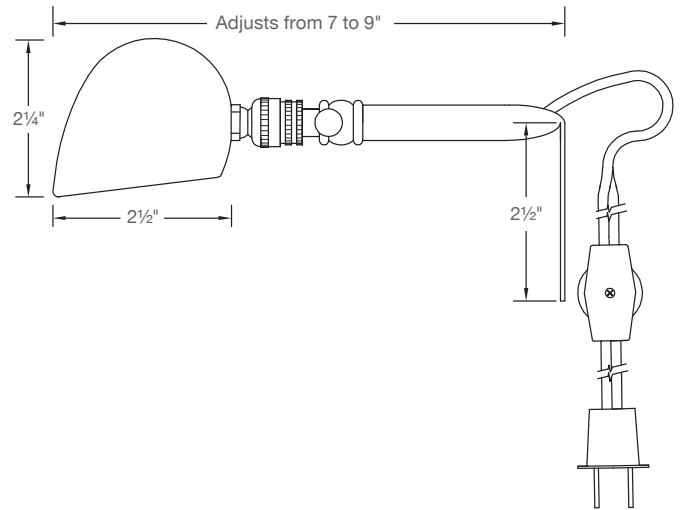
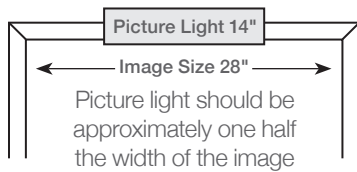

Specifications

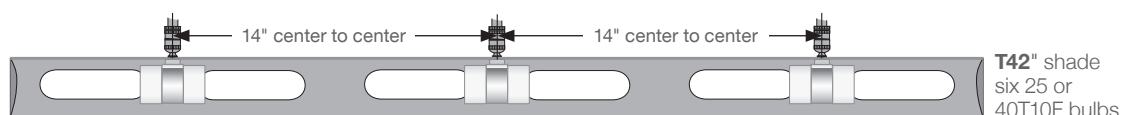
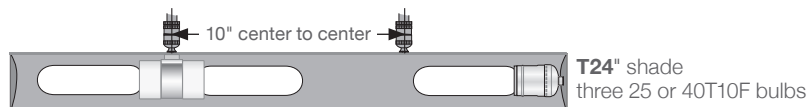
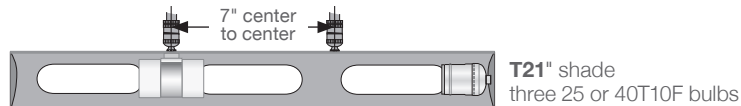
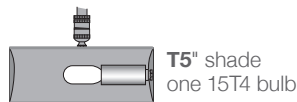

NOTE: Traditional Series Picture Lights with more than one arm, have a pre-wired, aluminum splice-box (2" x 2" x 5/8") which hangs behind the artwork.

When ordering the Traditional picture light note T then the shade size followed by the finish code.

Plug-In Advent Gemini LED

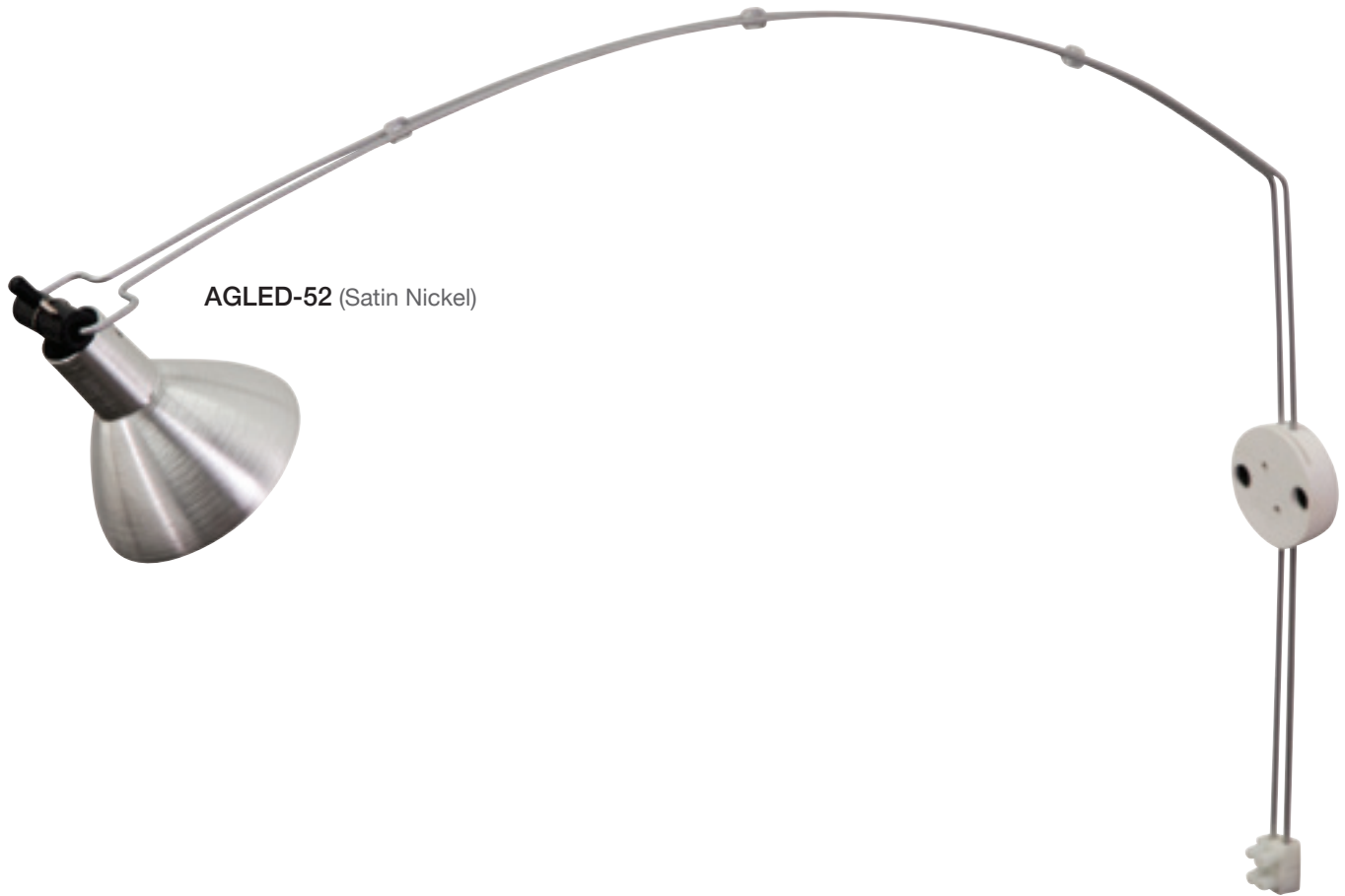

AGLED-52 (Satin Nickel)

Features

- No damaging UV
- Horizontal arm extension of 19"
- Swivel with lever at shade to adjust light
- MR16 LED bulb, 3.5 Watts, 3000K, 75 CRI, 320 Lumens included, 12 volt
- Illuminates a 3' x 3' area
- 10' cord with plug-in driver (2" x 1³/₈" x 1") with switch 3' from plug

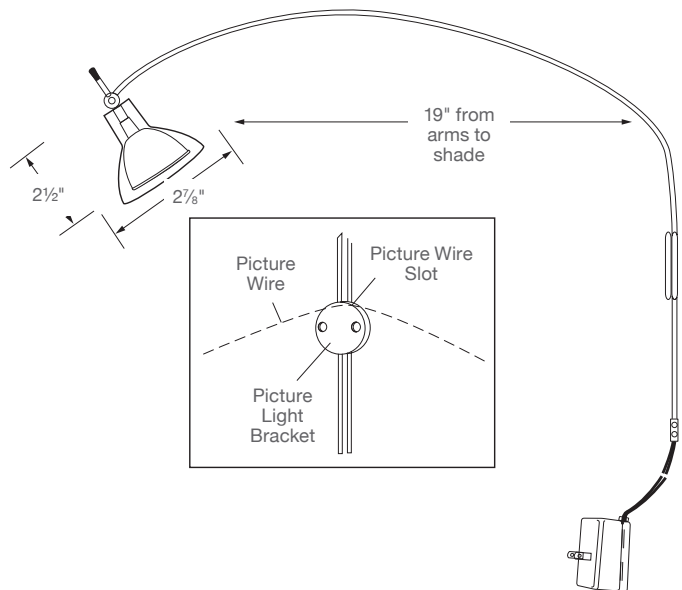

Finishes



Satin Nickel #52

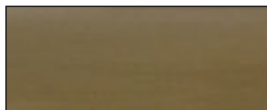

Antique Brass #71

Product Options:

AGLED-52

AGLED-71

Plug-In Advent Profile LED



APL16-52 (Satin Nickel)

Features

- No damaging UV
- Removable shade for easy LED replacement
- LED bi-pin bulb included
- Polished metal reflector in shade for maximum light output
- Mount to frame or wall with included hardware
- 10' white cord with plug-in driver (2¼" × 1⅜" × 1") with switch 3' from plug, 12 volt

Size Selection Guide

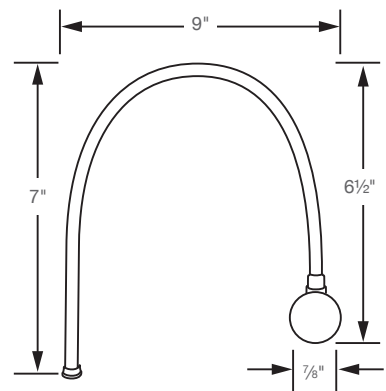
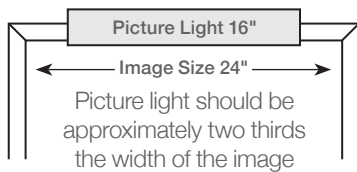

Finishes

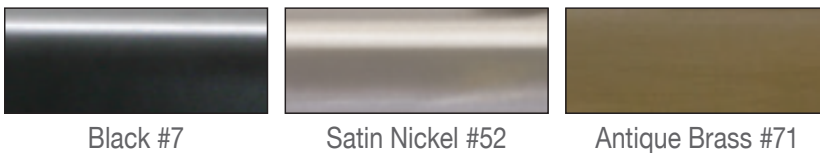

Product Options:

- APL16-7
- APL16-52
- APL16-71

Specifications



APL16" shade
two 3000K, 85 CRI, 2 Watts, 140 Lumen LED

Plug-In Horizon LED



HLEDZ12-62 (*Chrome*)

Finishes



Satin Brass #51



Satin Nickel #52



Chrome #62

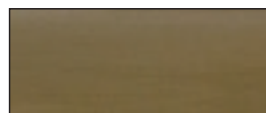

Antique Brass #71

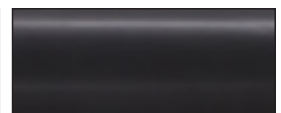

Oil Rubbed Bronze #91

Plug-In Horizon LED

HLEDZ26-51 (Satin Brass)



Features

- No damaging UV
- Line Voltage
- Dimmable to 5% with triac dimmer
- Diffused for even light spread
- 50,000 hour lifetime
- Five year warranty on LED array
- Swivel at shade for easy shade positioning
- Paintable 8' ivory cord with In-line switch 3' from plug
- Mount to frame or wall with included hardware
- Customization available upon request

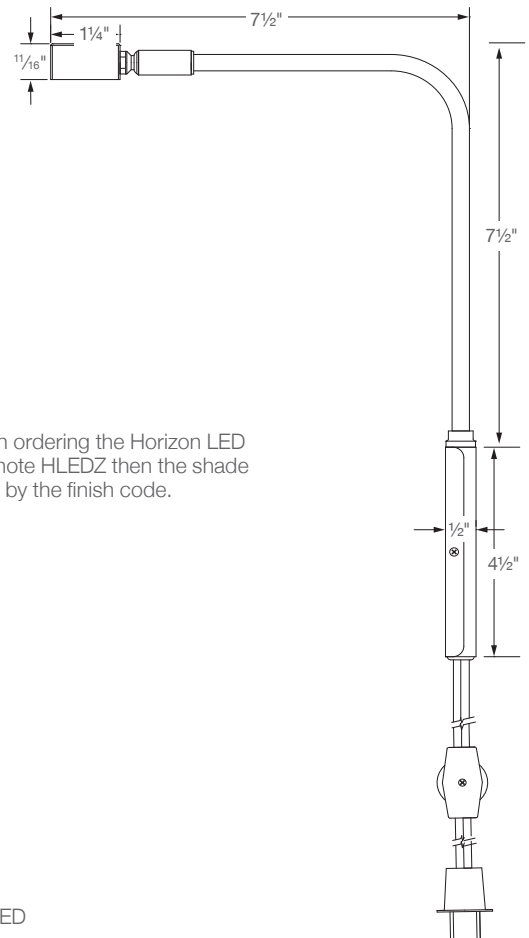

NOTE: When ordering the Horizon LED picture light note HLEDZ then the shade size followed by the finish code.

Size Selection Guide

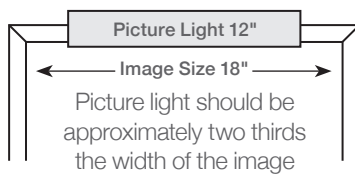

Specifications

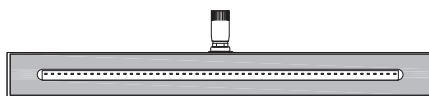

HLEDZ12" shade
2700K, 90+ CRI, 4.5 Watt, 360 Lumen LED

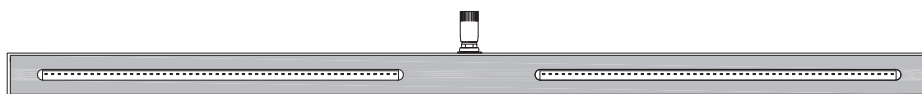

HLEDZ26" shade
2700K, 90+ CRI, 9 Watt, 720 Lumen LED

Plug-In Slim-Line™ LED



SLEDZ29-91 (*Oil Rubbed Bronze*)

Finishes

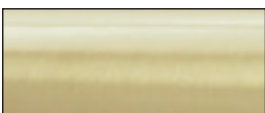

Satin Brass #51



Satin Nickel #52



Polished Brass #61

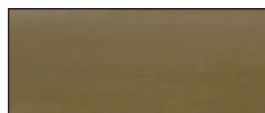

Antique Brass #71



Oil Rubbed Bronze #91

Plug-In Slim-Line™ LED



SLEDZ43-52 (Satin Nickel)

Features

- No damaging UV
- Line Voltage
- Dimmable to 5% with triac dimmer
- Diffused for even light spread
- 50,000 hour lifetime
- Five year warranty on LED array
- Shade rotates to adjust light
- Paintable 8' ivory cord with In-line switch 3' from plug
- Mount to frame or wall with included hardware
- Customization available upon request

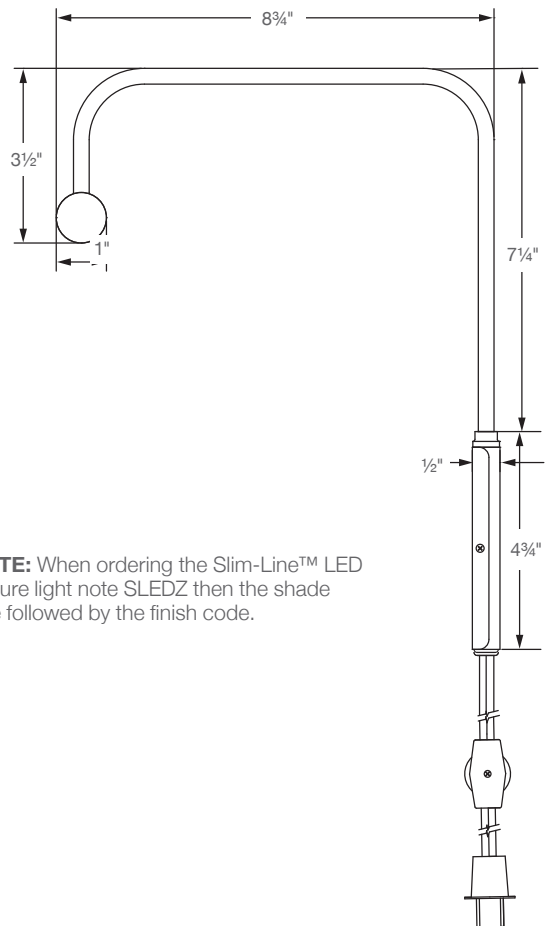

Size Selection Guide

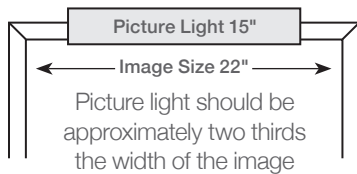

Specifications



SLEDZ15" shade
2700K, 90+ CRI, 4.5 Watt, 360 Lumen LED

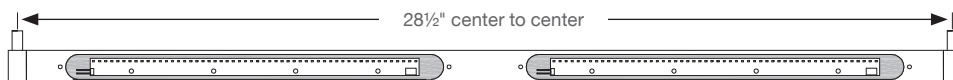

SLEDZ29" shade
2700K, 90+ CRI, 9 Watt, 720 Lumen LED



SLEDZ43" shade
2700K, 90+ CRI, 13.5 Watt, 1080 Lumen LED

Plug-In Traditional LED



TLEDZ14-71 (*Antique Brass*)

Finishes

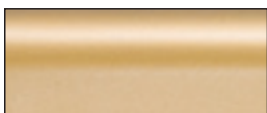

Gold #1



Bronze #5



Pewter #31

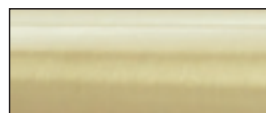

Satin Brass #51



Satin Nickel #52



Statuary Bronze #56



Polished Brass #61

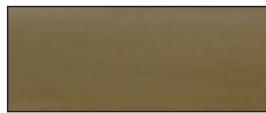

Antique Brass #71



Weathered Brass #76



Mahogany Bronze #81

Plug-In Traditional LED

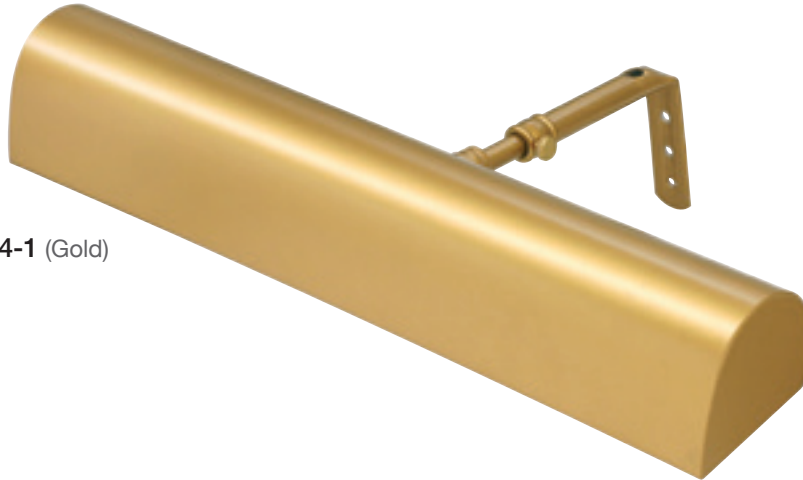

TLEDZ14-1 (Gold)

Features

- No damaging UV
- Line Voltage
- Dimmable to 5% with triac dimmer
- Diffused for even light spread
- 50,000 hour lifetime
- Five year warranty on LED array
- Swivel at shade for easy shade positioning
- Slide arm adjusts for horizontal extension
- Paintable 8' ivory cord with In-line switch 3' from plug
- Mount to frame or wall with included hardware
- Customization available upon request

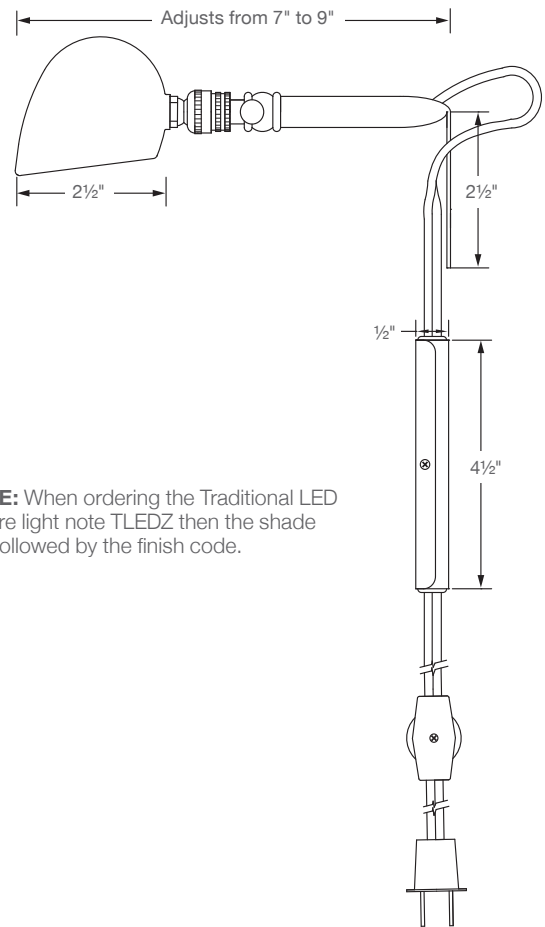

Size Selection Guide

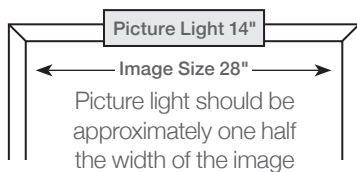

Specifications

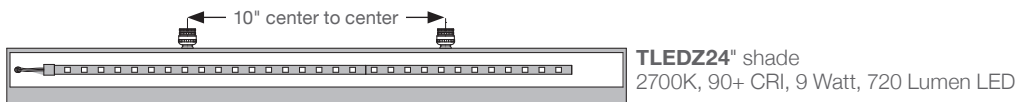

Plug-In Ultra Slim-Line™ LED



USLEDZ41-9 (White)

Finishes

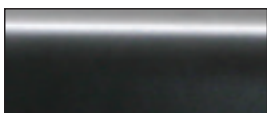

Black #7

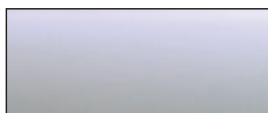

White #9

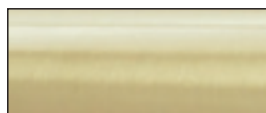

Satin Brass #51

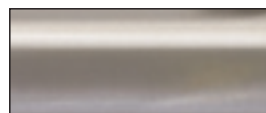

Satin Nickel #52

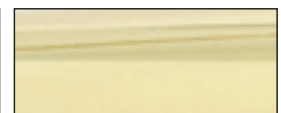

Polished Brass #61



Chrome #62

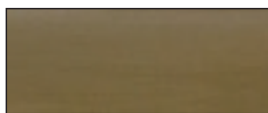

Antique Brass #71



Weathered Brass #76



Oil Rubbed Bronze #91

Plug-In Ultra Slim-Line™ LED

USLEDZ28-52 (Satin Nickel)

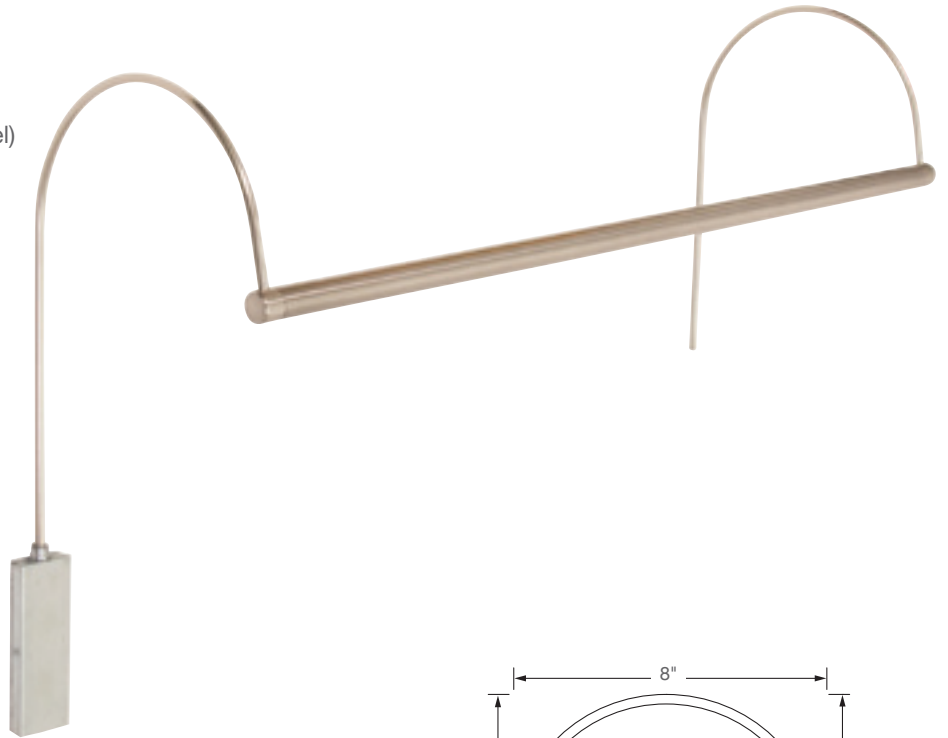

Features

- No damaging UV
- Line Voltage
- Dimmable to 5% with triac dimmer
- Diffused for even light spread
- 50,000 hour lifetime
- Five year warranty on LED array
- Shade rotates to adjust light
- Paintable 8' ivory cord with In-line switch 3' from plug
- Mount to frame or wall with included hardware
- Customization available upon request

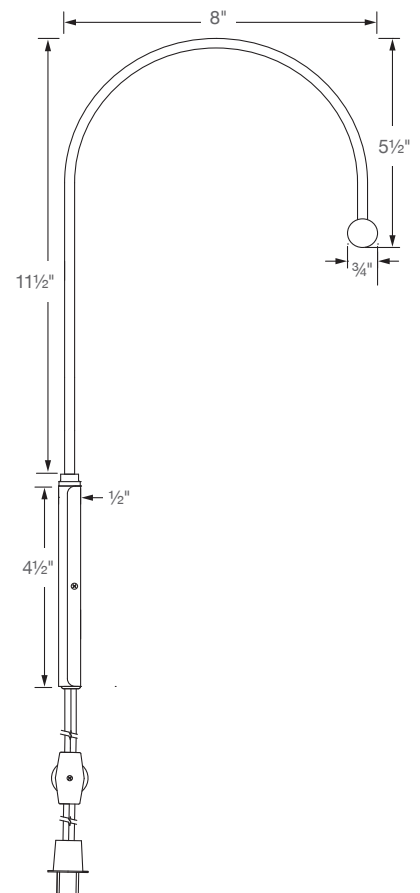

Size Selection Guide

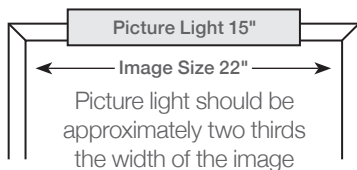

NOTE: When ordering the Ultra Slim-Line™ LED picture light note USLEDZ then the shade size followed by the finish code.

Specifications

← 14 1/2" center to center → **USLEDZ15"** shade
2700K, 90+ CRI,
4.5 Watt, 360 Lumen LED

← 27 1/2" center to center → **USLEDZ28"** shade
2700K, 90+ CRI,
9 Watt, 720 Lumen LED

← 40 1/4" center to center → **USLEDZ41"** shade
2700K, 90+ CRI, 13.5 Watt,
1080 Lumen LED

Plug-In Zenith LED



ZLEDZ12-91 (*Oil Rubbed Bronze*)

Finishes



Satin Brass #51



Satin Nickel #52



Chrome #62

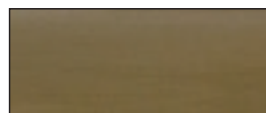

Antique Brass #71



Oil Rubbed Bronze #91

Plug-In Zenith LED

ZLEDZ36-62 (Chrome)



Features

- No damaging UV
- Line Voltage
- Dimmable to 5% with triac dimmer
- Diffused for even light spread
- 50,000 hour lifetime
- Five year warranty on LED array
- Swivel at shade for easy shade positioning
- Paintable 8' ivory cord with In-line switch 3' from plug
- Mount to frame or wall with included hardware
- Customization available upon request

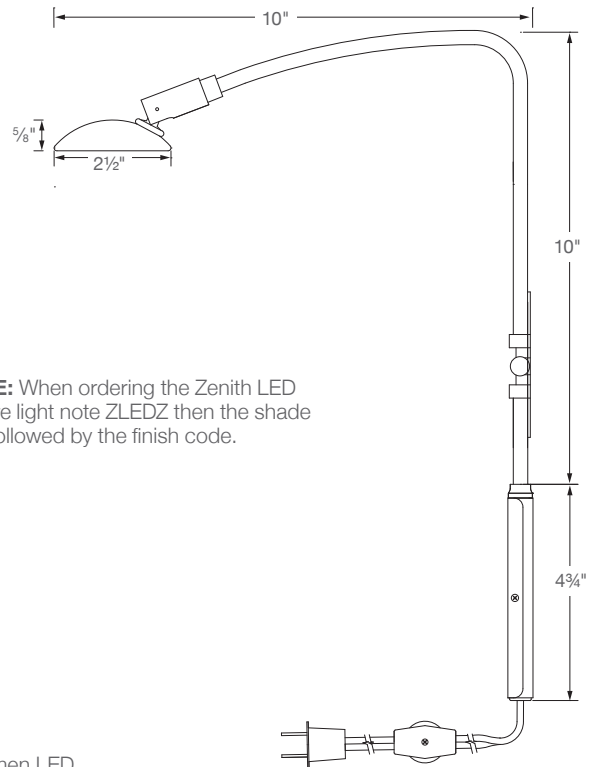

NOTE: When ordering the Zenith LED picture light note ZLEDZ then the shade size followed by the finish code.

Size Selection Guide

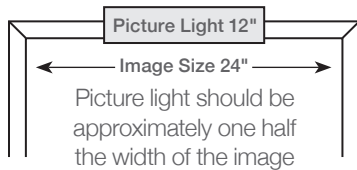

Specifications

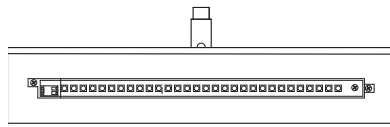

ZLEDZ12" shade
2700K, 90+ CRI, 4.5 Watt, 360 Lumen LED

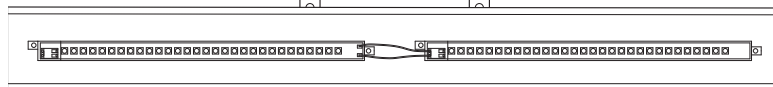
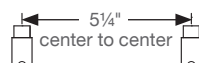

ZLEDZ24" shade
2700K, 90+ CRI, 9 Watt, 720 Lumen LED

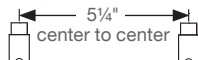

ZLEDZ36" shade
2700K, 90+ CRI,
13.5 Watts,
1080 Lumen LED

Picture Lights — Direct Wire



Krista Watterworth Design Studio/Jessica Glynn Photography

DSL24-52 (*Satin Nickel*)

Direct wire picture lights are the preferred installation for the contract industry. Mount your light on a junction box installed over art work so that the picture light sits a few inches from the top of the art. Use a dimmer switch to enhance the atmosphere. All direct wire lights are American Made.

Direct Wire Amelia LED

DALEDZ14-BLKPB

Finish: Black and Polished Brass



Features

- No damaging UV
- Line Voltage
- Dimmable to 5% with triac dimmer
- Diffused for even light spread
- 50,000 hour lifetime
- Five year warranty on LED array
- 3 swivel points for easy shade positioning
- Polished metal reflector in shade for maximum light output
- Backplate will cover standard junction box
- Customization available upon request

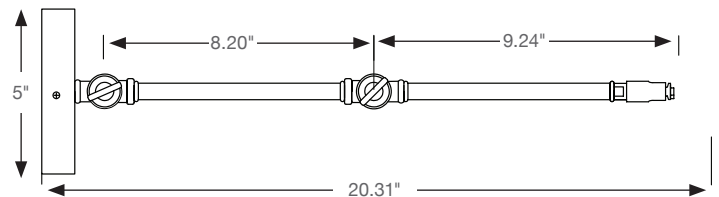
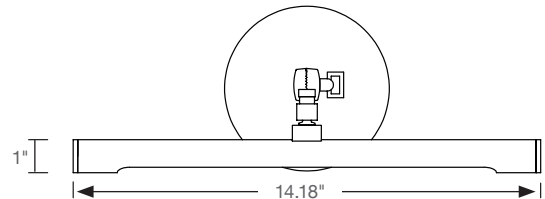

Size Selection Guide

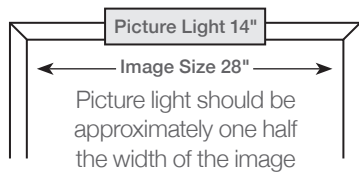

Finishes

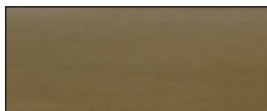

Antique Brass (AB)

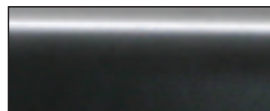

Black (BLK)

Product Options:
DALEDZ14-BLKPB
DALEDZ14-ABMB
DALEDZ14-BLKSN

Specifications

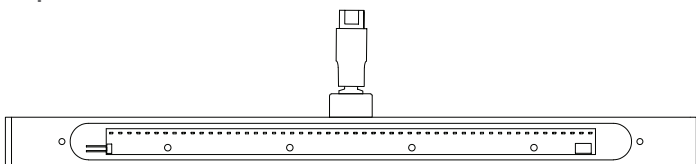

DALEDZ14" shade
 2700K, 90+ CRI, 4.5 Watts, 360 Lumens
 Backplate: 5"

Direct Wire Ava Incandescent



DA14-71 (Antique Brass)

Features

- Tilt socket allows for easy bulb replacement
- Pebbled aluminum reflector provides maximum light output
- 4½" H backplate will cover standard junction box
- Optional LED bulb available (LED 2.5W)

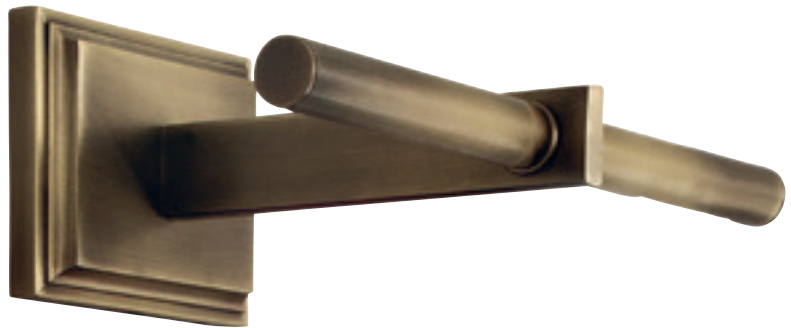

Size Selection Guide

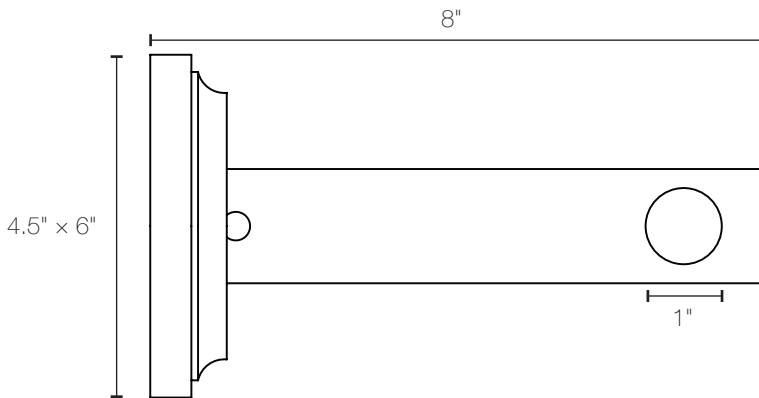
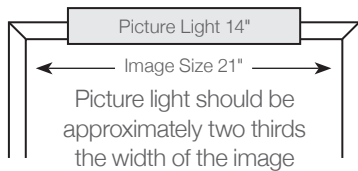

Finishes

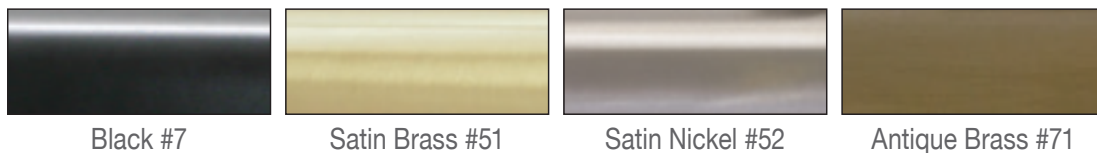

Specifications

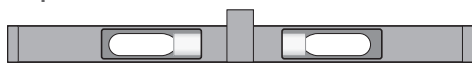

DA14" shade
two 15T4 bulbs included
Backplate: 4½" x 6"



DA24" shade
four 15T4 bulbs included
Backplate: 4½" x 6"

NOTE: When ordering the Direct Wire Ava picture light note DA then the shade size followed by the finish code.

Direct Wire Chelsea Incandescent



DCH25-7 (Black)



Features

- Tilt socket allows for easy bulb replacement
- Pebbled aluminum reflector provides maximum light output
- 5" backplate will cover standard junction box
- Optional LED bulb available (LED 2.5W)

Size Selection Guide

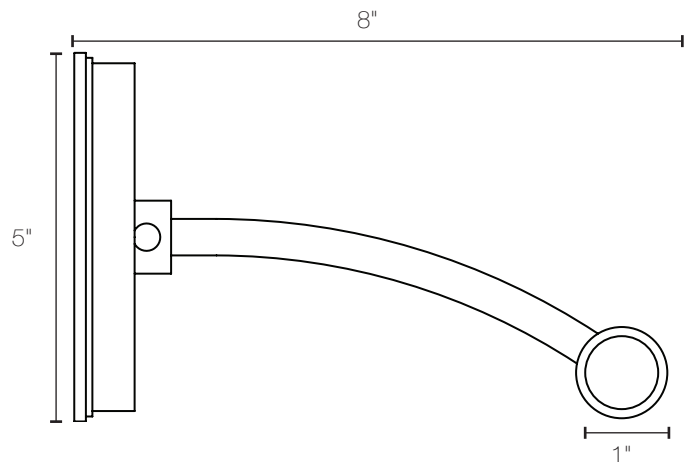
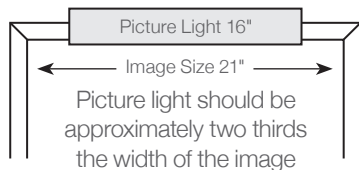

Finishes

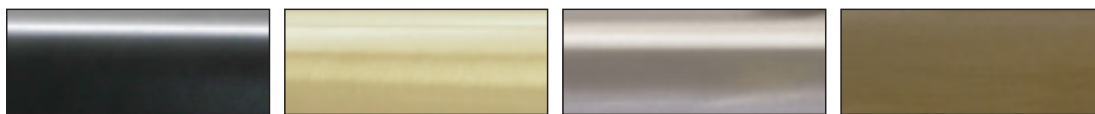

Black #7

Satin Brass #51

Satin Nickel #52

Antique Brass #71

Specifications



DCH16" shade
two 15T4 bulbs included
Backplate: 5" round



DCH25" shade
four 15T4 bulbs included
Backplate: 5" round

NOTE: When ordering the Direct Wire Chelsea picture light note DCH then the shade size followed by the finish code.

Direct Wire Contemporary Incandescent

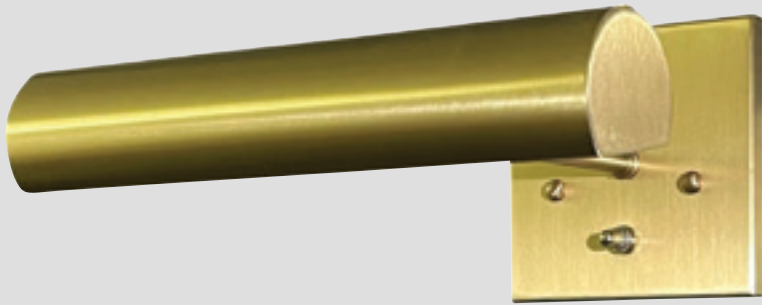

DC9-51 (*Satin Brass*)

Finishes

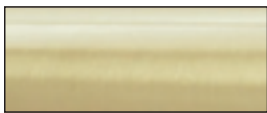

Satin Brass #51



Satin Nickel #52



Polished Brass #61

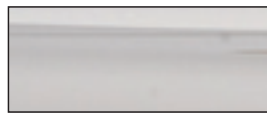

Chrome #62

Direct Wire Contemporary Incandescent



DC9-62 (Chrome)

Features

- Swivel at shade for easy shade positioning
- Polished metal reflector in shade for maximum light output
- 4½"H backplate will cover standard junction box
- Optional LED bulb available
- Customization available upon request

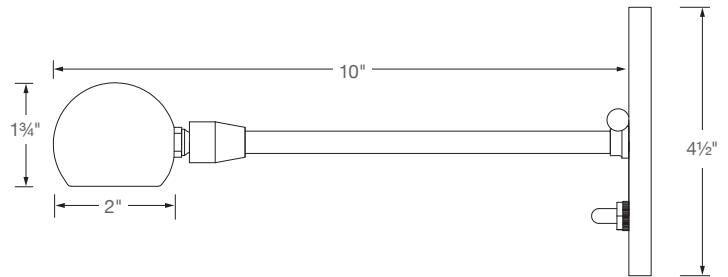

Size Selection Guide

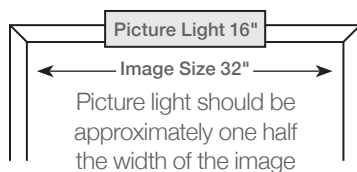

NOTE: When ordering the Direct Wire Contemporary picture light note DC then the shade size followed by the finish code.

Specifications

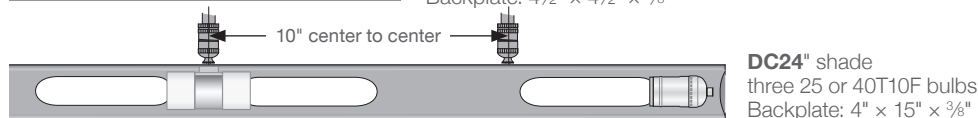
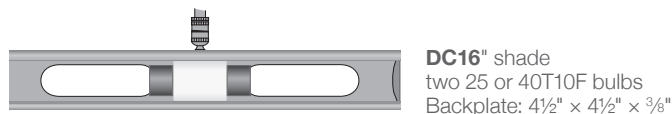

Direct Wire Library Incandescent



Features

- Swivel at shade for easy shade positioning
- Polished metal reflector in shade for maximum light output
- 2¾"H backplate will cover 2" x 4" junction box
- Optional LED bulb available
- Customization available upon request

Size Selection Guide

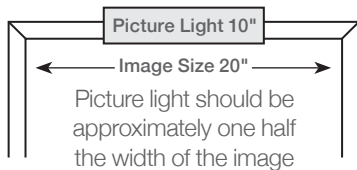

Available as a custom direct mount. Refer to page 375 for details.

Finishes

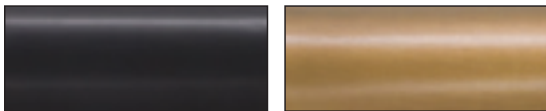

Oil Rubbed Bronze (OB) Weathered Brass (WB)

Specifications

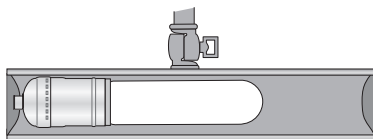

DL10" shade
one 25 or 40T10F bulbs
Backplate: 2¾ x 4½"

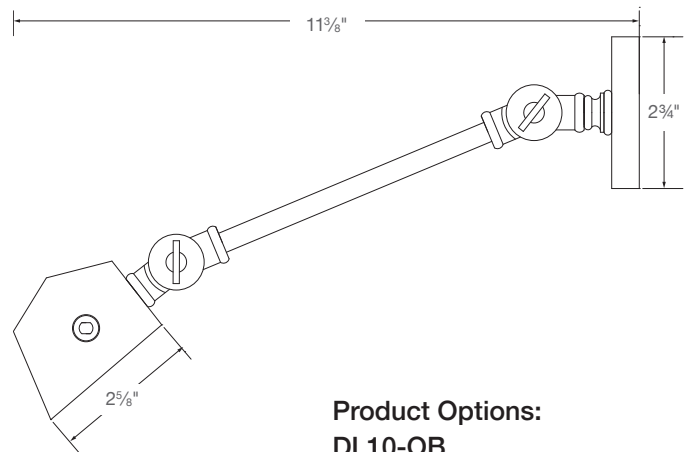

Product Options:

DL10-OB
DL10-WB

Direct Wire Library Incandescent



PL16-OB (Oil Rubbed Bronze)

Features

- Swivel at shade for easy shade positioning
- Paintable 8' ivory cord with In-line hi-lo switch 3' from plug
- Polished metal reflector in shade for maximum light output
- Includes 30" cord cover for plug in
- Full range dimmer on backplate
- Optional LED bulb available
- Customization available upon request



Available as a custom direct mount. Refer to page 375 for details.

Size Selection Guide

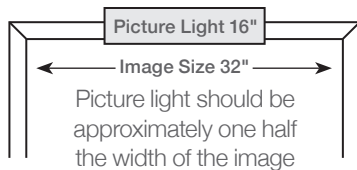

Finishes

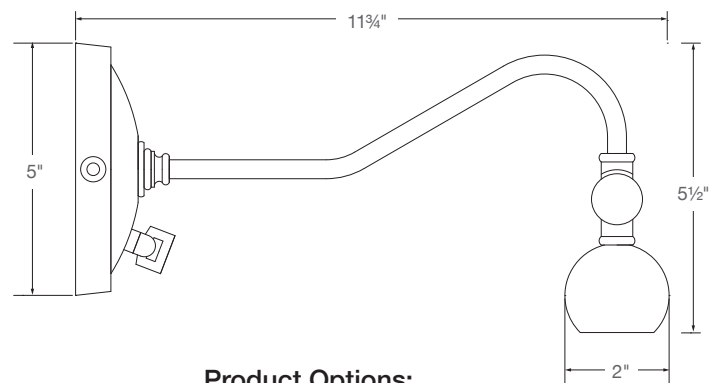
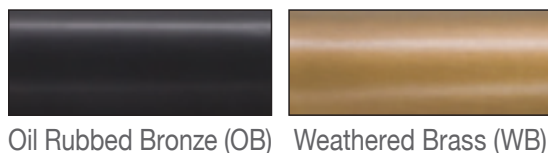

Product Options:
PL16-OB
PL16-WB

Specifications

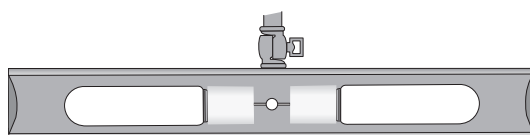

PL16" shade
two 25 or 40T10F bulbs
Backplate: 5" diameter

Direct Wire Oxford Incandescent



DOX16-AB (*Antique Brass*)

Finishes



Antique Brass (AB)

Oil Rubbed Bronze (OB)

Satin Nickel (SN)

Direct Wire Oxford Incandescent



DOX42-SN (Satin Nickel)

Features

- Swivel at shade for easy shade positioning
- Polished metal reflector in shade for maximum light output
- 4½"H backplate will cover standard junction box
- Optional LED bulb available
- Customization available upon request

Size Selection Guide

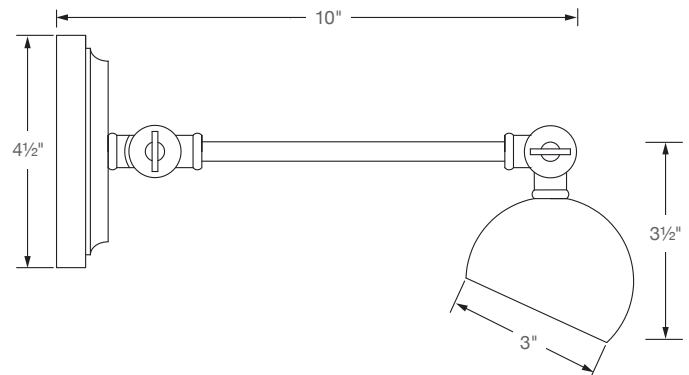
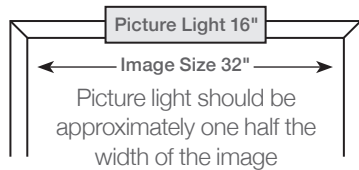

Specifications

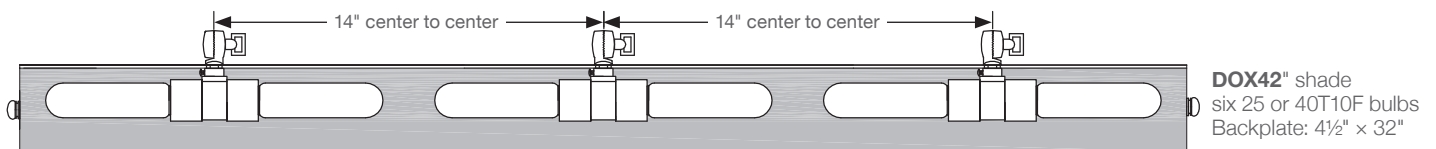
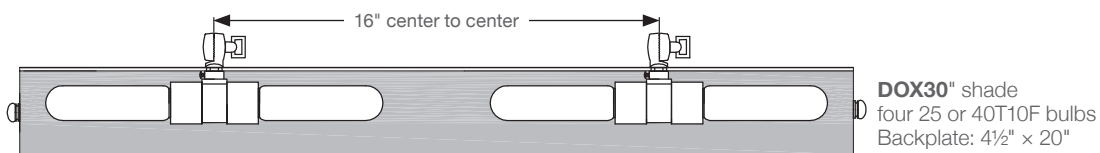
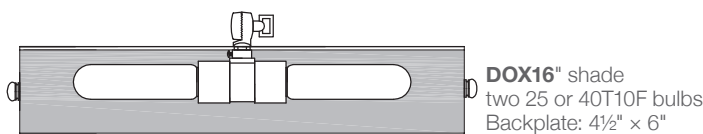

NOTE: When ordering the Direct Wire Oxford picture light note DOX then the shade size followed by the finish code.

Direct Wire Slim-Line Incandescent



Lisa Wolfe Design, LTD/Todd Pierson Photography

DSL24-51 (*Satin Brass*)

Finishes

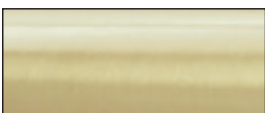

Satin Brass #51



Satin Nickel #52

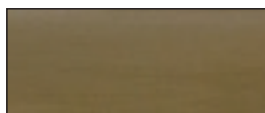

Antique Brass #71

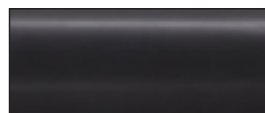

Oil Rubbed Bronze #91

Direct Wire Slim-Line Incandescent

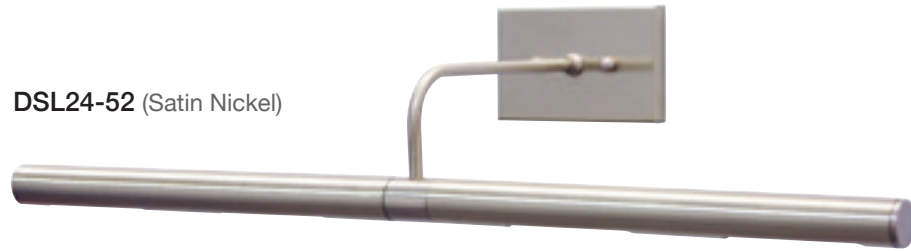

DSL24-52 (Satin Nickel)

Features

- Shade rotates to adjust light
- Tilt socket allows for easy bulb replacement
- Pebbled aluminum reflector provides maximum light output
- 2 3/4"H backplate fits 2" x 4" horizontally mounted junction box
- Customization available upon request
- Optional LED bulbs available (LED 2.5W)

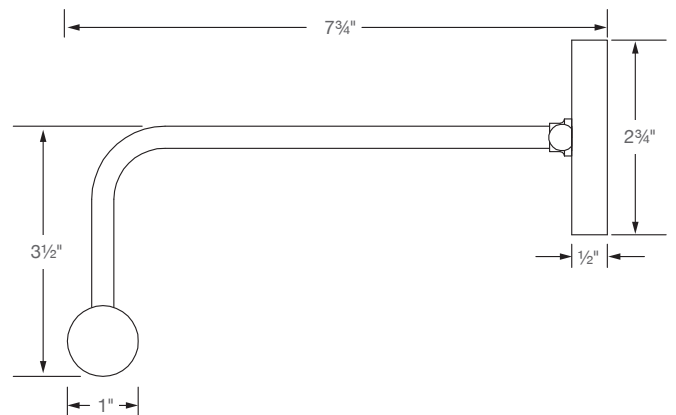

Size Selection Guide

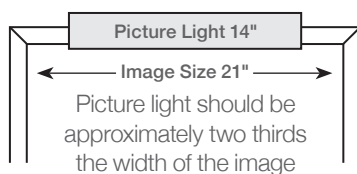

NOTE: When ordering the Direct Wire Slim-Line™ picture light note DSL then the shade size followed by the finish code.

Specifications

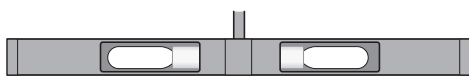

DSL14" shade
two 15T4 bulbs
included

Backplate:
2 3/4"H x 4 1/2"W

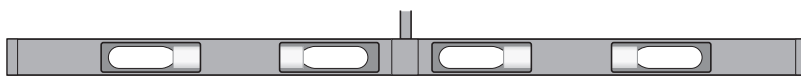

DSL24" shade
four 15T4 bulbs
included

Backplate:
2 3/4"H x 4 1/2"W

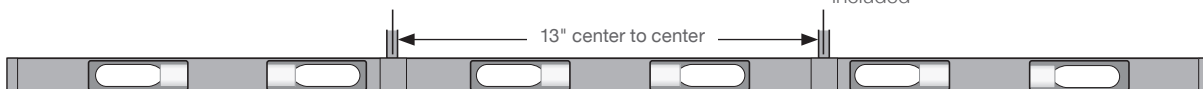

DSL36" shade
six 15T4 bulbs
included
Backplate:
2 3/4"H x 17 1/2"W

Direct Wire Slim-Line XL Incandescent



DXL14-91 (Oil Rubbed Bronze)

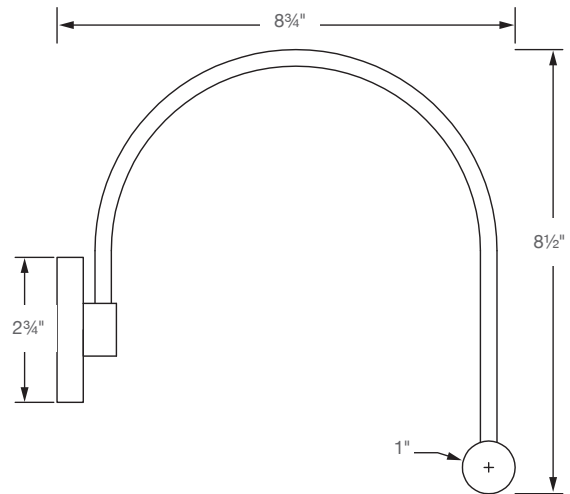
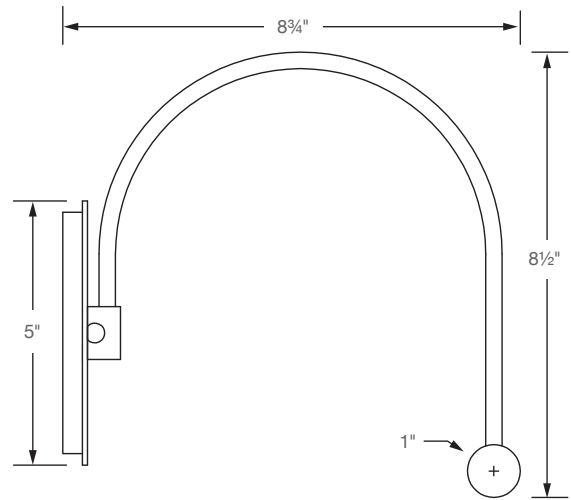

Features

- Shade rotates to adjust light
- Tilt socket allows for easy bulb replacement
- Pebbled aluminum reflector provides maximum light output
- 5" diameter backplate fits octagon junction box (14" x 24")
- 2 3/4"H backplate fits 2" x 4" horizontally mounted junction box (36")
- Customization available upon request
- Optional LED bulbs available (LED 2.5W)

Size Selection Guide

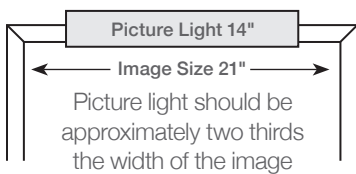

Finishes



Specifications

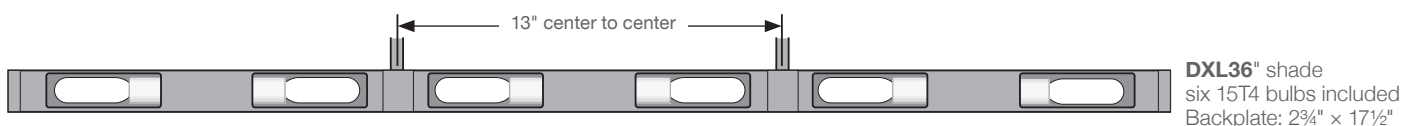
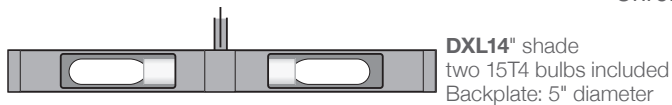

NOTE: When ordering the Direct Wire Slim-Line™ XL picture light note DXL then the shade size followed by the finish code.

Direct Wire Steamer Incandescent



DST42-SNBLK (Satin Nickel and Black)

Features

- Swivel at shade for easy shade positioning
- Polished metal reflector in shade for maximum light output
- 4½"H backplate will cover standard junction box
- Customization available upon request

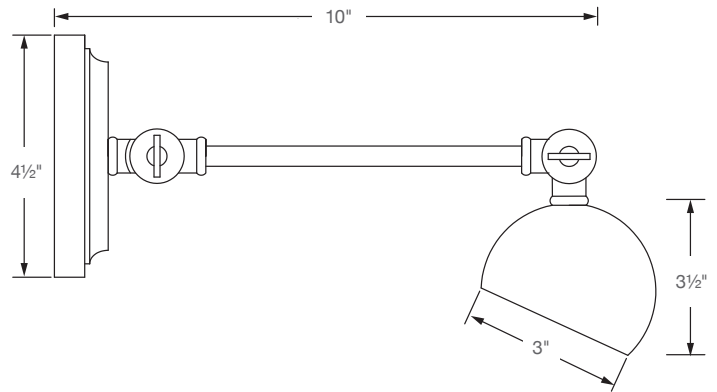

Size Selection Guide

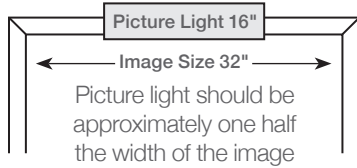

Finishes



Antique Brass and Mahogany Bronze (ABMB)

Mahogany Bronze and Antique Brass (MBAB)

Satin Nickel and Black (SNBLK)

Specifications

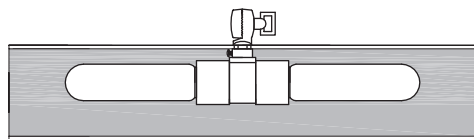

DST16 shade
two 25 or 40T10F bulbs
Backplate: 4½" x 6"

NOTE: When ordering the Direct Wire Steamer picture light note DST then the shade size followed by the finish code.

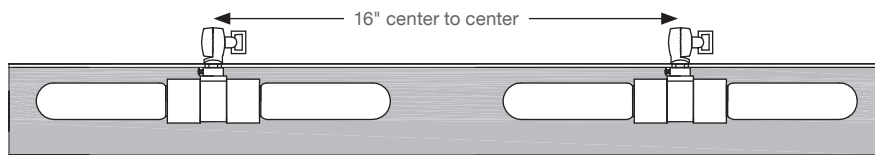

DST30 shade
four 25 or 40T10F bulbs
Backplate: 4½" x 20"

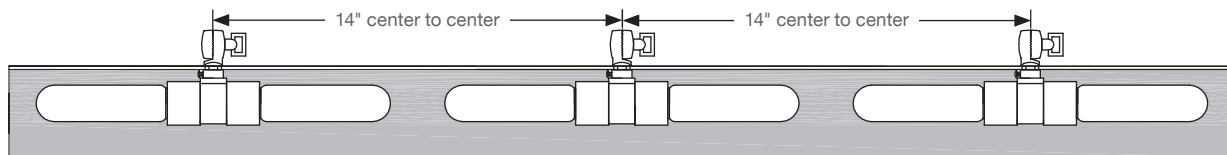

DST42 shade
six 25 or 40T10F bulbs
Backplate: 4½" x 32"

Direct Wire Traditional Incandescent



DT14-71 (*Antique Brass*)

Finishes



Satin Brass #51



Satin Nickel #52

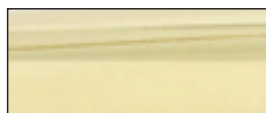

Polished Brass #61

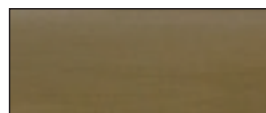

Antique Brass #71



Mahogany Bronze #81

Direct Wire Traditional Incandescent



DT24-81 (Mahogany Bronze)

Features

- Swivel at shade for easy shade positioning
- Polished metal reflector in shade for maximum light output
- 4½"H backplate will cover standard junction box
- Optional LED bulb available
- Customization available upon request

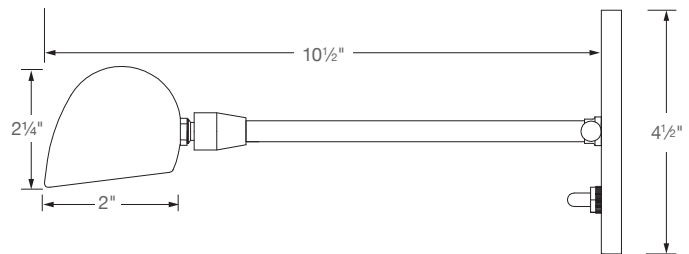

Size Selection Guide

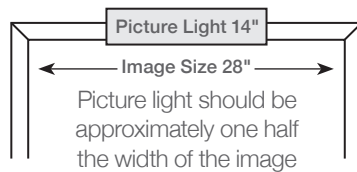

NOTE: When ordering the Direct Wire Traditional picture light note DT then the shade size followed by the finish code.

Specifications

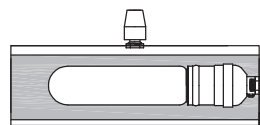

DT8" shade
one 25 or 40T10F bulb
Backplate: 4½" x 4½"

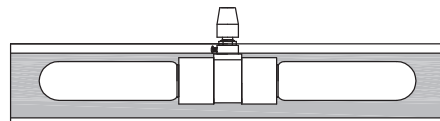

DT14" shade
two 25 or 40T10F bulbs
Backplate: 4½" x 4½"

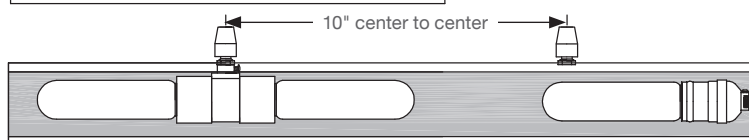

DT24" shade
three 25 or 40T10F bulbs
Backplate: 4" x 15"

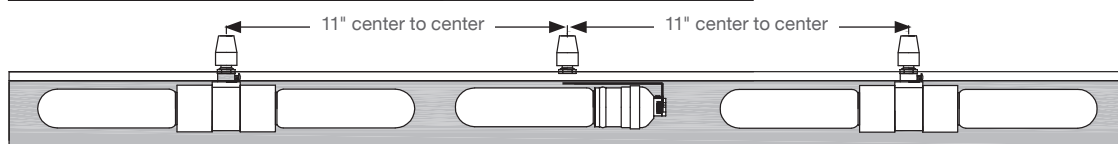

DT36" shade
five 25 or 40T10F bulbs
Backplate: 4" x 26"

Direct Wire Ultra-Wide Picture Light



DUW14-52 (*Satin Nickel*)

Finishes



Satin Nickel #52



Chrome #62



Mahogany Bronze #81

Direct Wire Ultra-Wide Picture Light

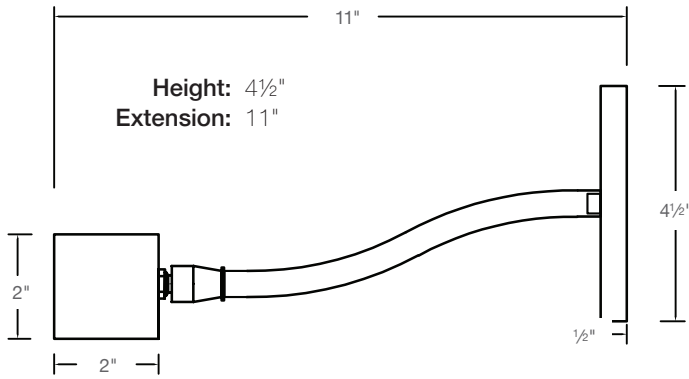

DUW14-52
Finish: Satin Nickel



Features

- Swivel at shade for easy shade positioning
- Polished metal reflector in shade for maximum light output
- 4 1/2"H backplate will cover standard junction box
- Optional LED bulb available
- Customization available upon request

DUW24-81
Finish: Mahogany Bronze



NOTE: When ordering the Direct Wire Ultra-Wide picture light note DUW then the shade size followed by the finish code.

DUW36-62
Finish: Chrome

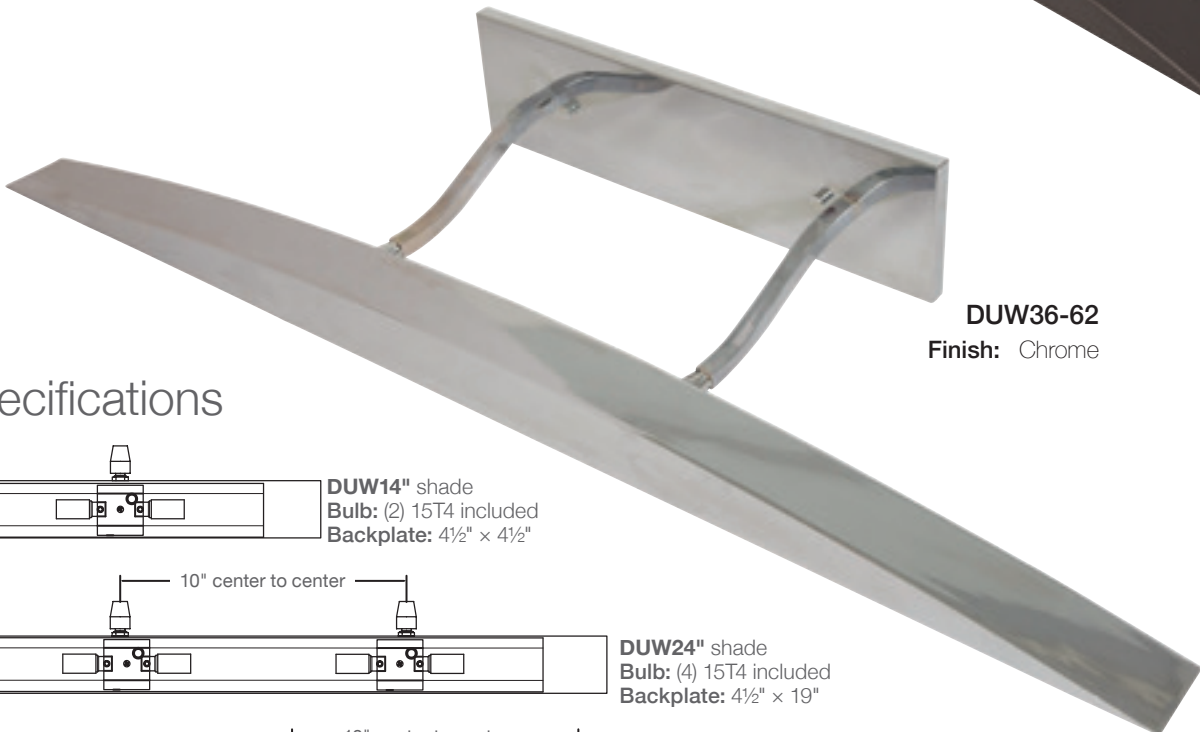

Specifications

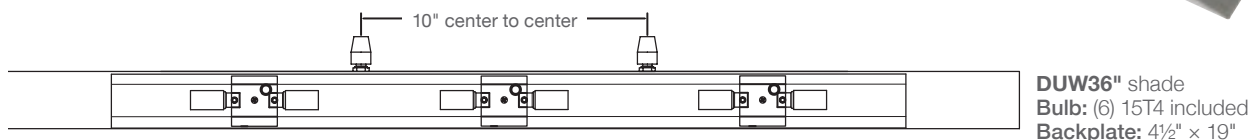
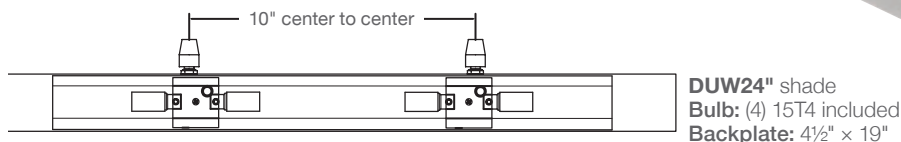
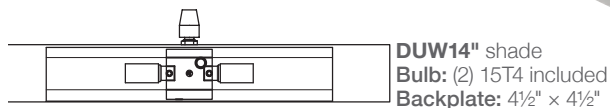

Direct Wire Contemporary LED



DCLEDZ12-71 (*Antique Brass*)

Finishes



Satin Brass #51



Satin Nickel #52

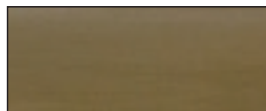

Antique Brass #71

Direct Wire Contemporary LED

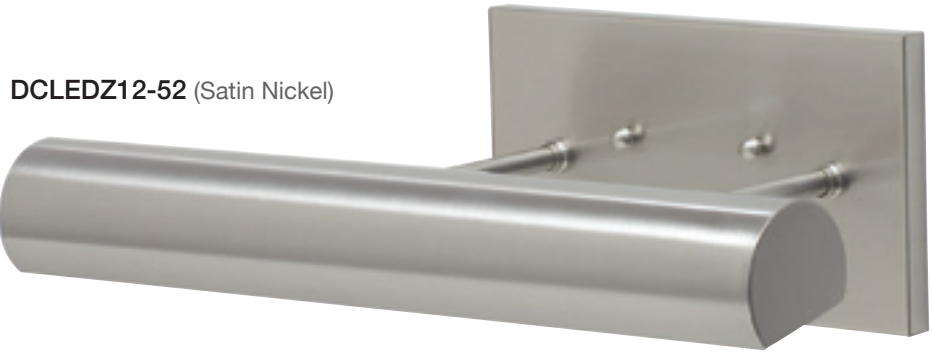

DCLEDZ12-52 (Satin Nickel)

Features

- No damaging UV
- Line Voltage
- Dimmable to 5% with triac dimmer
- Diffused for even light spread
- 50,000 hour lifetime
- Five year warranty on LED array
- Swivel at shade for easy shade positioning
- Polished metal reflector in shade for maximum light output
- 4½"H backplate will cover standard junction box
- Customization available upon request

Size Selection Guide

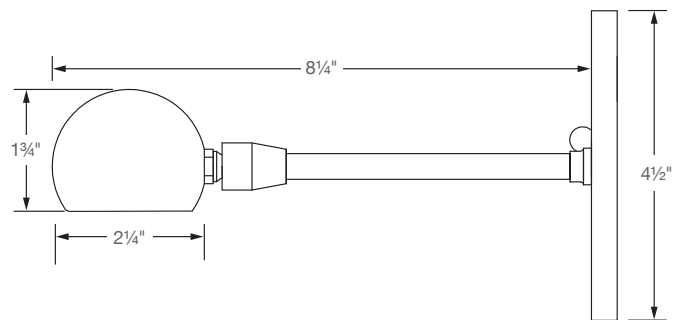
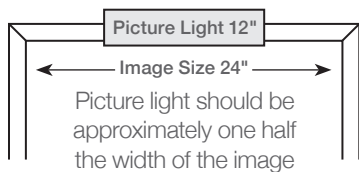

NOTE: When ordering the Direct Wire Contemporary LED picture light note DCLEDZ then the shade size followed by the finish code.

Specifications

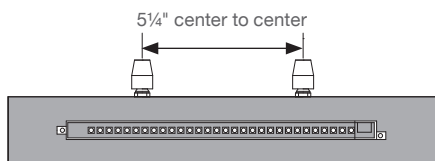

DCLEDZ12" shade
2700K, 90+ CRI, 4.5 Watts, 360 Lumen
Backplate: 4½" x 8"

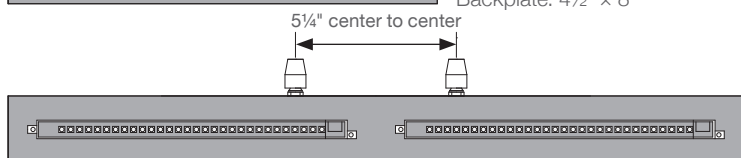

DCLEDZ24" shade
2700K, 90+ CRI, 9 Watt, 720 Lumen
Backplate: 4½" x 8"

Direct Wire Guilford LED



DGLEDZ24-AB (*Antique Brass*)

Finishes

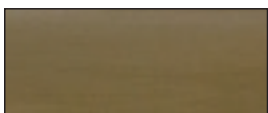

Antique Brass (AB)



Oil Rubbed Bronze (OB)

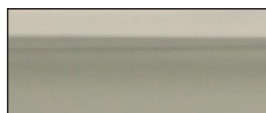

Polished Nickel (PN)

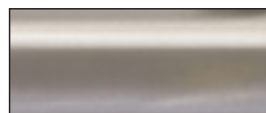

Satin Nickel (SN)

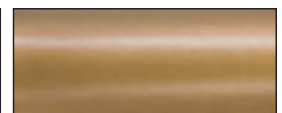

Weathered Brass (WB)

Direct Wire Guilford LED



DGLEDZ36-SN (Satin Nickel)

Features

- No damaging UV
- Line Voltage
- Dimmable to 5% with triac dimmer
- Diffused for even light spread
- 50,000 hour lifetime
- Five year warranty on LED array
- Swivel at shade for easy shade positioning
- Polished metal reflector in shade for maximum light output
- 4½"H backplate will cover standard junction box
- Customization available upon request

Size Selection Guide

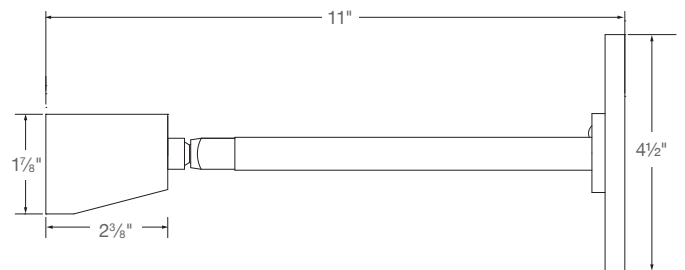
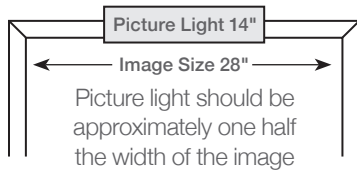

Specifications

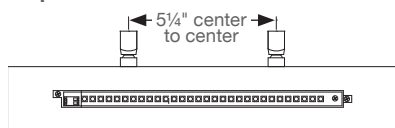

DGLEDZ14" shade
2700K, 90+ CRI, 4.5 Watt, 360 Lumen
LED Backplate: 4½" × 8"

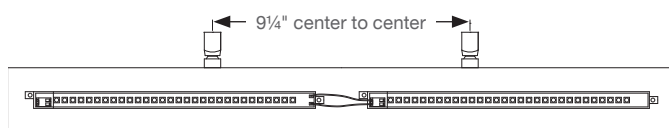

DGLEDZ24" shade
2700K, 90+ CRI, 9 Watt, 720 Lumen LED
Backplate: 4½" × 12"

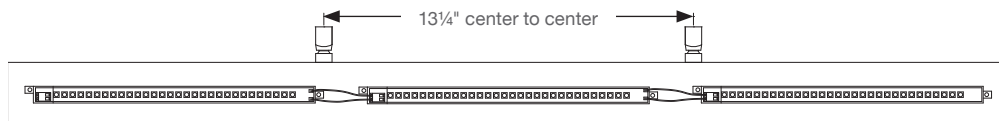

DGLEDZ36" shade
2700K, 90+ CRI, 13.5 Watt,
1080 Lumen LED
Backplate: 4½" × 16"

NOTE: When ordering the Direct Wire Guilford LED picture light note DGLEDZ then the shade size followed by the finish code.

Direct Wire Halo LED



DHA05-BLK (*Black*)

Finishes

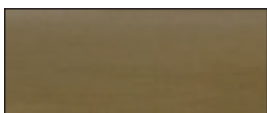

Antique Brass (AB)

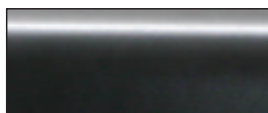

Black (BLK)



Mahogany Bronze (MB)



Satin Nickel (SN)

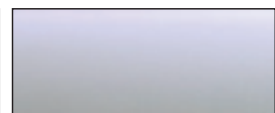

White (WT)

Direct Wire Halo LED

DHA05-SN (Satin Nickel)



Features

- Direct wire only
- No damaging UV
- Dimmable with an triac dimmer
- Diffused for even light spread
- 50,000 hour lifetime
- Swivel at shade for easy shade positioning
- 5" diameter backplate will cover octagon junction box

Specifications



DHA05
one 3000K, 80CRI, 6.5 Watt, 600 Lumen LED
Backplate: 5" diameter

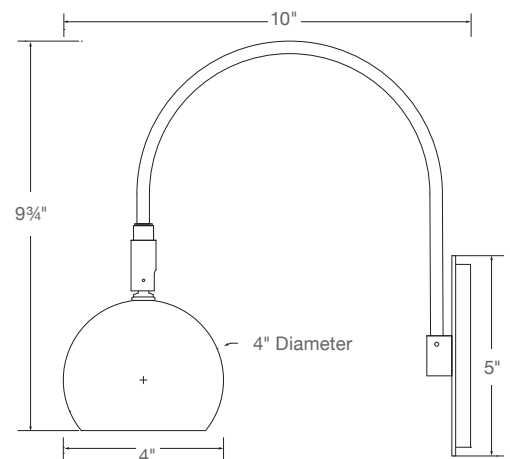

Product Options:

- DHA05-AB
- DHA05-BLK
- DHA05-MB
- DHA05-SN
- DHA05-WT

Direct Wire Horizon LED



DHLEDZ12-51 (*Satin Brass*)

Finishes

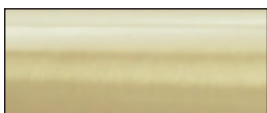

Satin Brass #51



Satin Nickel #52



Chrome #62

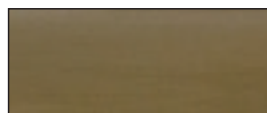

Antique Brass #71



Oil Rubbed Bronze #91

Direct Wire Horizon LED



DHLEDZ26-52 (Satin Nickel)

Features

- No damaging UV
- Line Voltage
- Dimmable to 5% with triac dimmer
- Diffused for even light spread
- 50,000 hour lifetime
- Five year warranty on LED array
- Swivel at shade for easy shade positioning
- Polished metal reflector in shade for maximum light output
- 4½"H backplate will cover standard junction box
- Customization available upon request

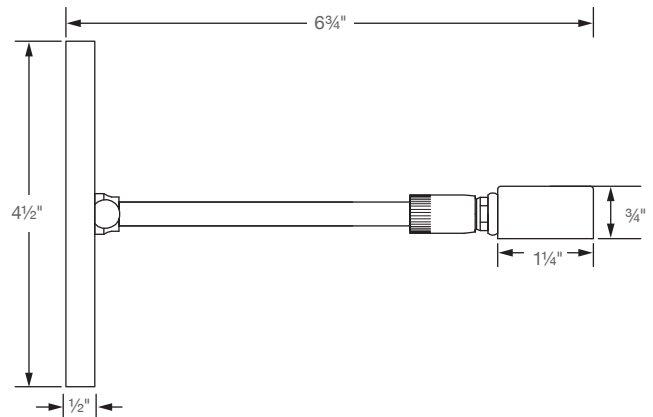

Size Selection Guide

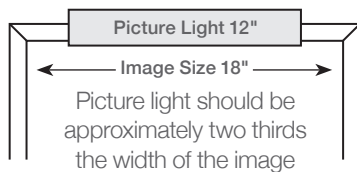

NOTE: When ordering the Direct Wire Horizon LED picture light note DHLEDZ then the shade size followed by the finish code.

Specifications

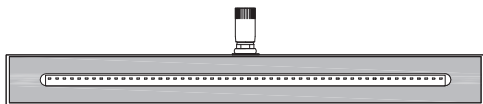

DHLEDZ12" shade
2700K, 90+ CRI, 4.5 Watt, 360 Lumen LED
Backplate: 4½" × 4½"

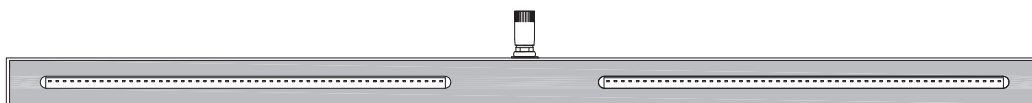

DHLEDZ26" shade
2700K, 90+ CRI, 9 Watt,
720 Lumen LED
Backplate: 4½" × 4½"

Direct Wire Library LED



LLED30-SN (*Satin Nickel*)

Finishes

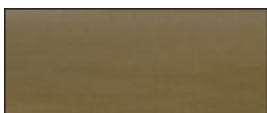

Antique Brass (AB)



Oil Rubbed Bronze (OB)



Satin Nickel (SN)

Direct Wire Library LED



Features

- Direct wire only
- No damaging UV
- Dimmable with an triac dimmer
- Diffused for even light spread
- 50,000 hour lifetime
- Multiple swivels for easy shade positioning
- 5" diameter backplate will cover octagon junction box
- One integrated 3000K, 90 CRI, 6.5 Watt, 600 Lumen LED included

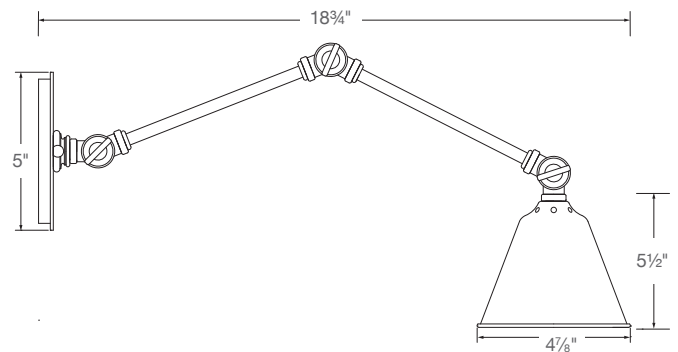

Product Options:

LLED30-AB
LLED30-OB
LLED30-SN

Direct Wire Mendon LED



DMLEDZ15-91 (*Oil Rubbed Bronze*)

Finishes

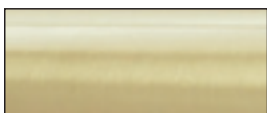

Satin Brass #51



Satin Nickel #52



Chrome #62

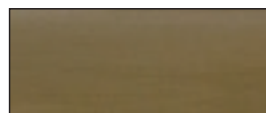

Antique Brass #71

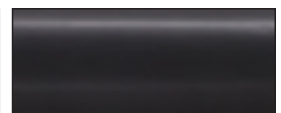

Oil Rubbed Bronze #91

Direct Wire Mendon LED

DMLEDZ15-71 (Antique Brass)



Features

- No damaging UV
- Line Voltage
- Dimmable to 5% with triac dimmer
- Diffused for even light spread
- 50,000 hour lifetime
- Five year warranty on LED array
- Swivel at shade for easy shade positioning
- Polished metal reflector in shade for maximum light output
- 5" x 6" cover plate included for use with 4" x 4" junction box
- Customization available upon request

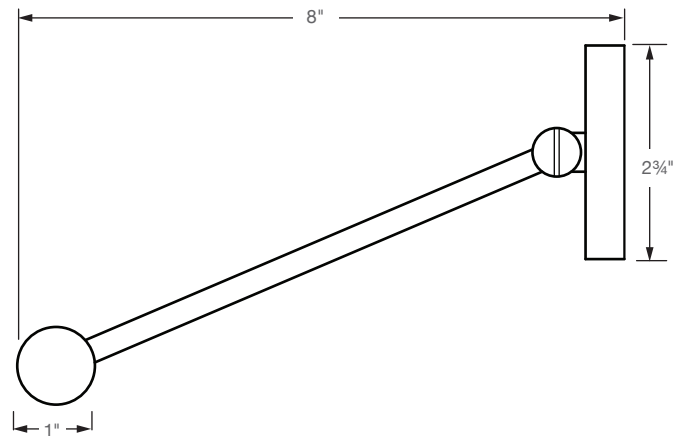

Size Selection Guide

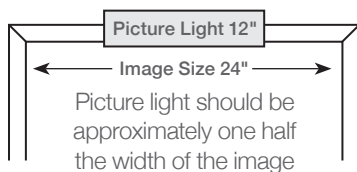

NOTE: When ordering the Direct Wire Mendon LED picture light note DMLEDZ then the shade size followed by the finish code.

Specifications



DMLEDZ15 shade
2700K, 90+ CRI, 4.5 Watt, 360 Lumen LED
Backplate: 2 3/4" x 19"

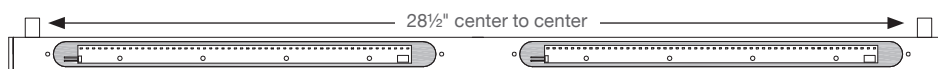

DMLEDZ29 shade
2700K, 90+ CRI, 9 Watt, 720 Lumen LED
Backplate: 2 3/4" x 33"

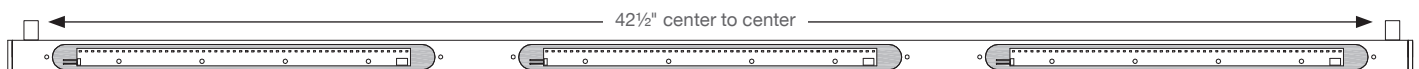

DMLEDZ43 shade
2700K, 90+ CRI, 13.5 Watt, 1080 Lumen LED
Backplate: 2 3/4" x 47"

Direct Wire Oxford LED



DOXLEDZ30-AB (*Antique Brass*)

Finishes

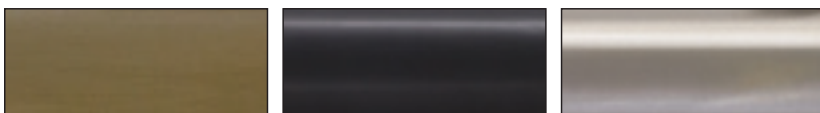

Antique Brass (AB)

Oil Rubbed Bronze (OB)

Satin Nickel (SN)

Direct Wire Oxford LED



DOXLEDZ30-OB (Oil Rubbed Bronze)

Features

- No damaging UV
- Line Voltage
- Dimmable to 5% with triac dimmer
- Diffused for even light spread
- 50,000 hour lifetime
- Five year warranty on LED array
- Swivel at shade for easy shade positioning
- Polished metal reflector in shade for maximum light output
- 4½"H backplate will cover standard junction box
- Customization available upon request

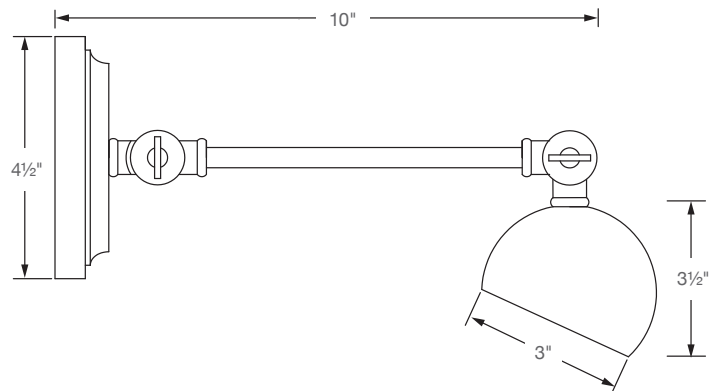

Size Selection Guide

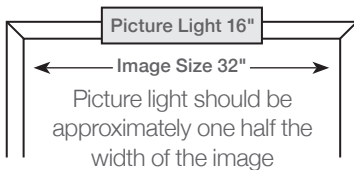

NOTE: When ordering the Direct Wire Oxford LED picture light note DOXLEDZ then the shade size followed by the finish code.

Specifications

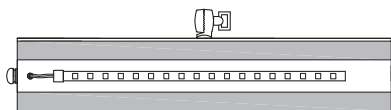

DOXLEDZ16" shade
2700K, 90+ CRI, 4.5 Watt, 360 Lumen LED
Backplate: 4½" x 6"

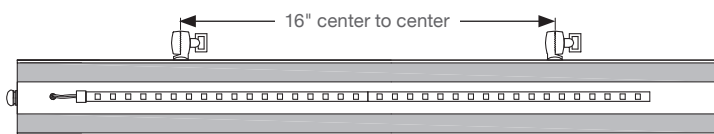

DOXLEDZ30" shade
2700K, 90+ CRI, 9 Watt, 720 Lumen LED
Backplate: 4½" x 20"

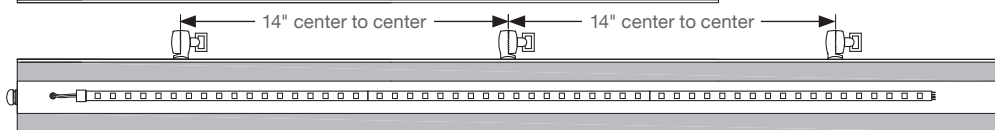

DOXLEDZ42" shade
2700K, 90+ CRI, 13.5 Watt, 1080 Lumen LED
Backplate: 4½" x 32"

Direct Wire Slim-Line LED



DSLEDZ14-52 (*Satin Nickel*)

Finishes

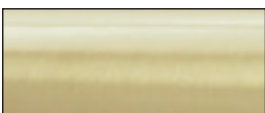

Satin Brass #51



Satin Nickel #52

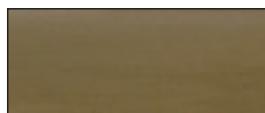

Antique Brass #71



Oil Rubbed Bronze #91

Direct Wire Slim-Line LED

DSLEDZ14-51 (Satin Brass)

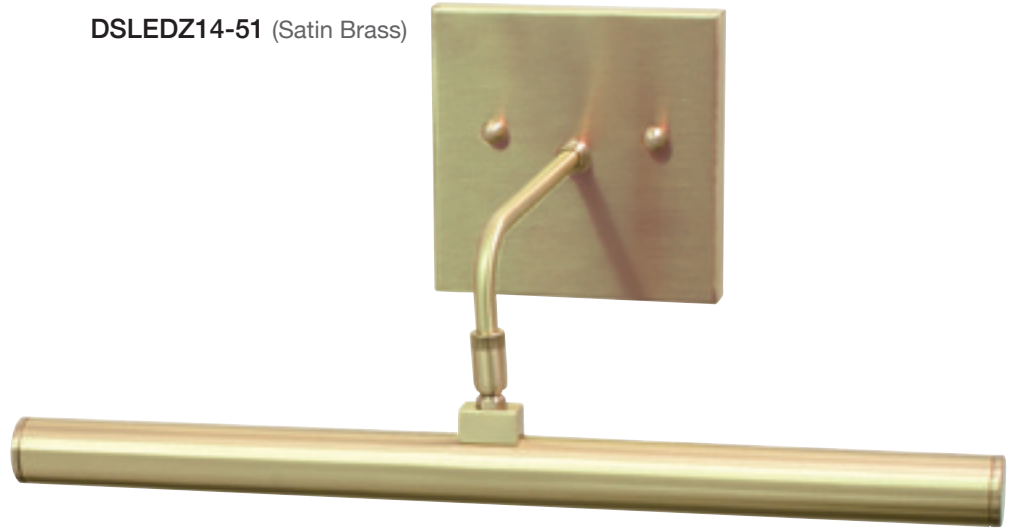

Features

- No damaging UV
- Line Voltage
- Dimmable to 5% with triac dimmer
- Diffused for even light spread
- 50,000 hour lifetime
- Five year warranty on LED array
- Shade Rotates to adjust light
- Polished metal reflector in shade for maximum light output
- 4½"H backplate will cover standard junction box
- Customization available upon request

Size Selection Guide

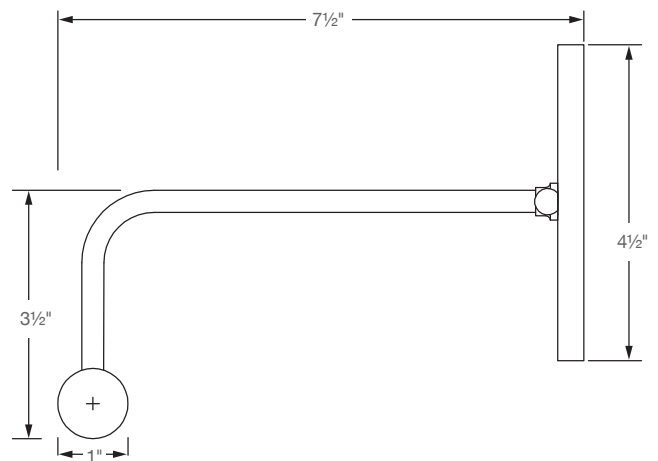
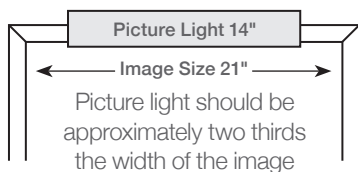

NOTE: When ordering the Direct Wire Slim-Line™ LED picture light note DSLEDZ then the shade size followed by the finish code.

Swivel is only on the 14" shade.

Specifications

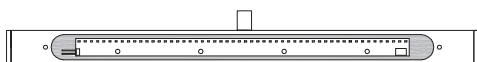

DSLEDZ14" shade
2700K, 90+ CRI, 4.5 Watt, 360 Lumen LED
Backplate: 4½" x 4½"



DSLEDZ28" shade
2700K, 90+ CRI, 9 Watt, 720 Lumen LED
Backplate: 4½" x 4½"

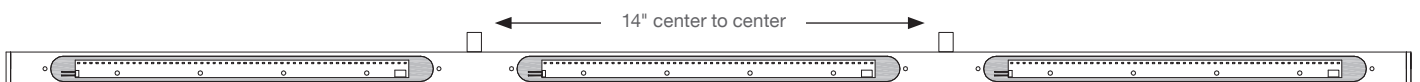

DSLEDZ43" shade
2700K, 90+ CRI, 13.5 Watt, 1080 Lumen LED
Backplate: 4½" x 17¾"

Direct Wire Slim-Line XL LED Picture Light



DXLEDZ16-62 (Chrome)

Finishes

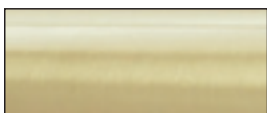

Satin Brass #51



Satin Nickel #52

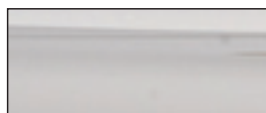

Chrome #62

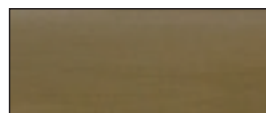

Antique Brass #71



Oil Rubbed Bronze #91

Direct Wire Slim-Line XL LED Picture Light

Features

- No damaging UV
- Line Voltage
- Dimmable to 5% with triac dimmer
- Diffused for even light spread
- 50,000 hour lifetime
- Five year warranty on LED array
- Shade rotates to adjust light
- 5" backplate will cover standard junction box
- Customization available upon request



DXLEDZ16-91
Finish: Oil Rubbed Bronze

NOTE: When ordering the Direct Wire Slim-Line™ XL LED picture light note DXLEDZ then the shade size followed by the finish code.

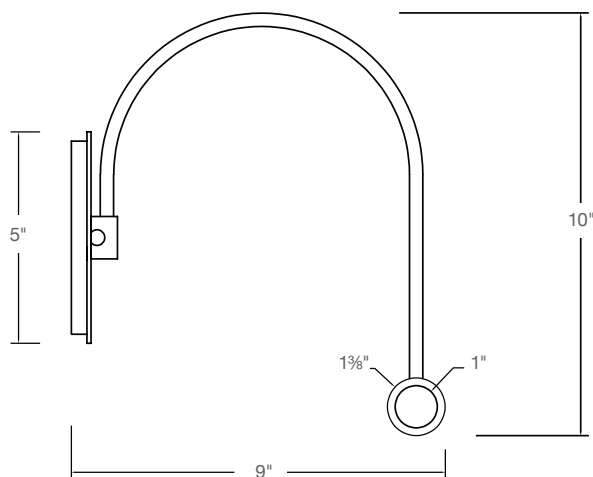

DXLEDZ30-62
Finish: Chrome

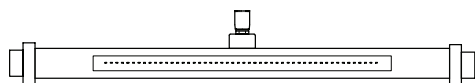

DXLEDZ16" shade
LED: 2700K, 90 CRI, 4.5 Watts,
360 Lumens Included

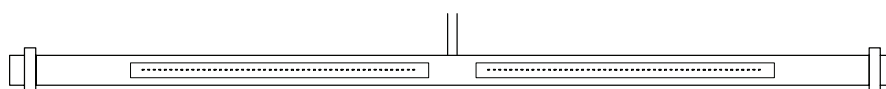

DXLEDZ30" shade
LED: 2700K, 90 CRI, 9 Watts,
720 Lumens Included

Direct Wire Steamer LED



DSTLEDZ16-MBAB (*Mahogany Bronze with Antique Brass*)

Finishes



Antique Brass and
Mahogany Bronze
(ABMB)



Mahogany Bronze
and Antique Brass
(MBAB)



Satin Nickel
and Black
(SNBLK)

Direct Wire Steamer LED

DSTLEDZ42-ABMB
(Antique Brass and Mahogany Bronze)



Features

- No damaging UV
- Line Voltage
- Dimmable to 5% with triac dimmer
- Diffused for even light spread
- 50,000 hour lifetime
- Five year warranty on LED array
- Swivel at shade for easy shade positioning
- Polished metal reflector in shade for maximum light output
- 4½"H backplate will cover standard junction box
- Customization available upon request

Size Selection Guide

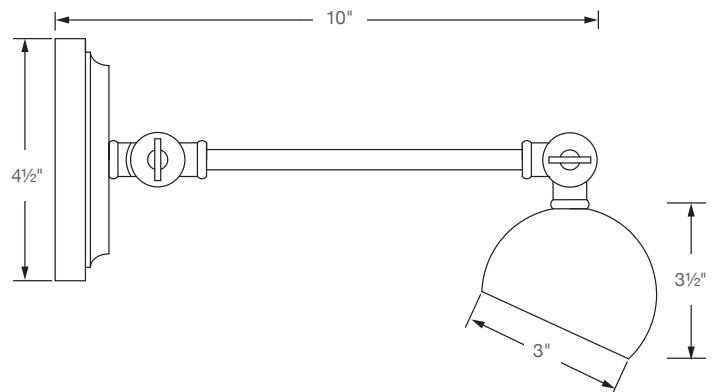
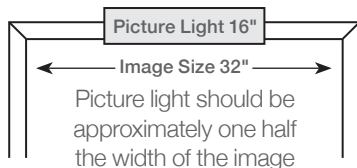

NOTE: When ordering the Direct Wire Steamer LED picture light note DSTLEDZ then the shade size followed by the finish code.

Specifications

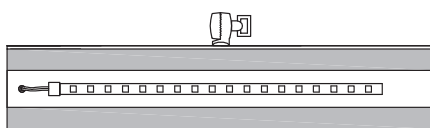

DSTLEDZ16" shade
2700K, 90+ CRI, 4.5 Watt,
360 Lumen LED
Backplate: 4½" x 6"

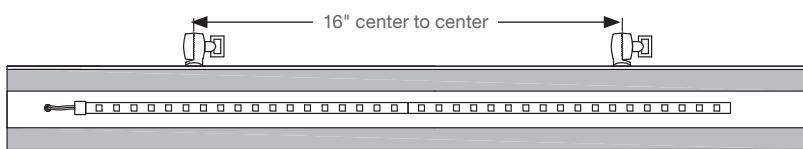

DSTLEDZ30" shade
2700K, 90+ CRI, 9 Watt,
720 Lumen LED
Backplate: 4½" x 20"

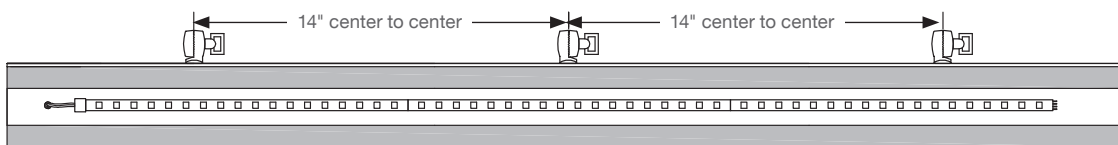

DSTLEDZ42" shade
2700K, 90+ CRI, 13.5 Watt,
1080 Lumen LED
Backplate: 4½" x 32"

Direct Wire Traditional LED



DTLEDZ14-81 (Mahogany Bronze)



DTLEDZ14-51 (Satin Brass)

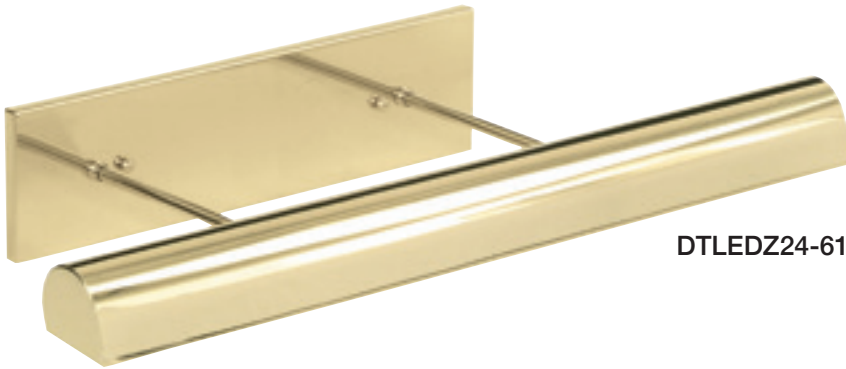

DTLEDZ24-61 (Polished Brass)

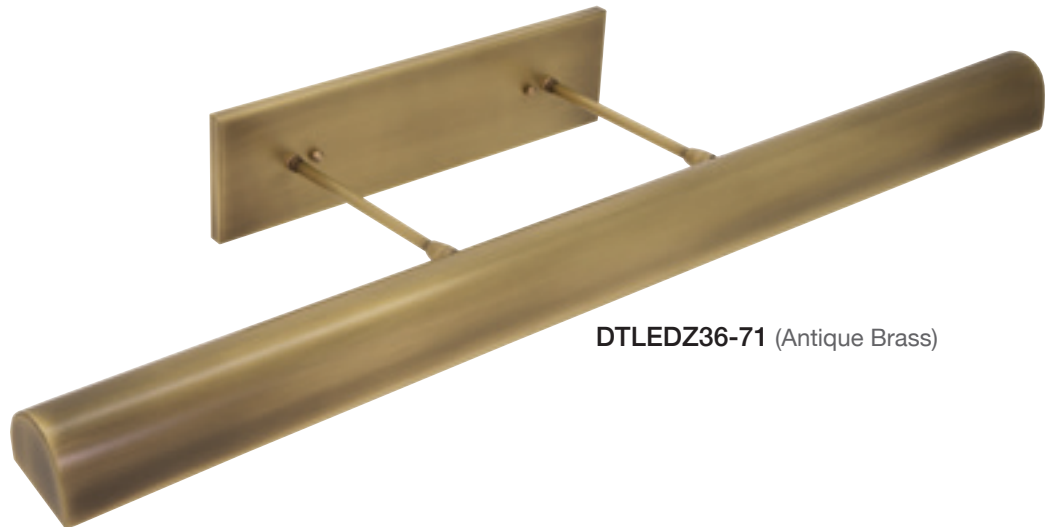

DTLEDZ36-71 (Antique Brass)

Finishes

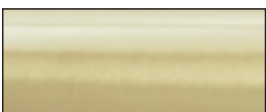

Satin Brass #51



Satin Nickel #52

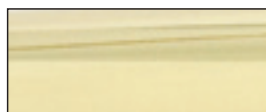

Polished Brass #61

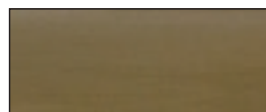

Antique Brass #71



Mahogany Bronze #81

Direct Wire Traditional LED



DTLEDZ14-81 (Mahogany Bronze)

Features

- No damaging UV
- Line Voltage
- Dimmable to 5% with triac dimmer
- Diffused for even light spread
- 50,000 hour lifetime
- Five year warranty on LED array
- Swivel at shade for easy shade positioning
- Polished metal reflector in shade for "maximum light output"
- 4"H backplate will cover standard junction box
- Customization available upon request

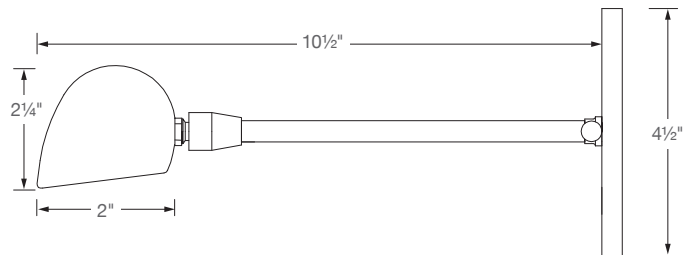

Size Selection Guide

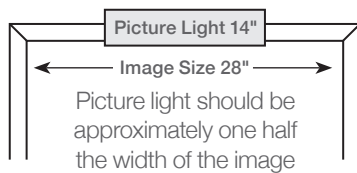

NOTE: When ordering the Direct Wire Traditional LED picture light note DTLEDZ then the shade size followed by the finish code.

Specifications

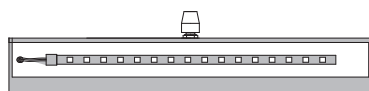

DTLEDZ14 shade
2700K, 90+ CRI, 4.5 Watt, 360 Lumen LED
Backplate: 4 1/2" x 4 1/2"

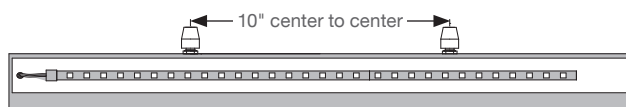

DTLEDZ24 shade
2700K, 90+ CRI, 9 Watt, 720 Lumen LED
Backplate: 4" x 15"

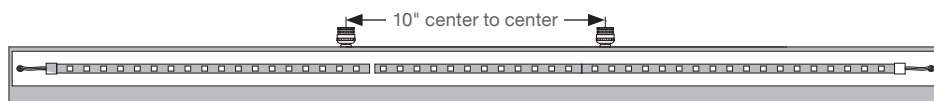

DTLEDZ36 shade
2700K, 90+ CRI, 13.5 Watts, 1080 Lumen LED
Backplate: 4" x 15"

Direct Wire Zenith LED



DZLEDZ12-91 (*Oil Rubbed Bronze*)

Finishes

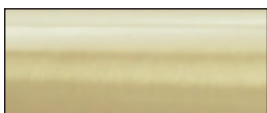

Satin Brass #51



Satin Nickel #52



Chrome #62

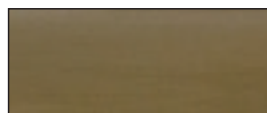

Antique Brass #71



Oil Rubbed Bronze #91

Direct Wire Zenith LED

DZLEDZ36-52 (Satin Nickel)



Features

- No damaging UV
- Line Voltage
- Dimmable to 5% with triac dimmer
- Diffused for even light spread
- 50,000 hour lifetime
- Five year warranty on LED array
- Swivel at shade for easy shade positioning
- Polished metal reflector in shade for maximum light output
- 4½"H backplate will cover standard junction box
- Customization available upon request

Size Selection Guide

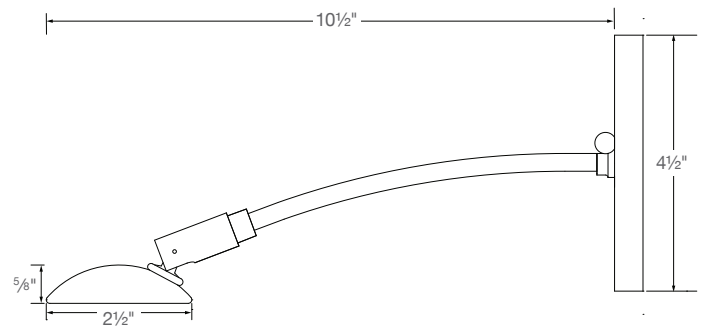
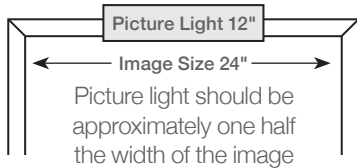

NOTE: When ordering the Direct Wire Zenith LED picture light note DZLEDZ then the shade size followed by the finish code.

Specifications

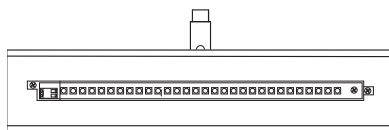

DZLEDZ12" shade
2700K, 90+ CRI, 4.5 Watt, 360 Lumen LED
Backplate: 4½" x 4½"

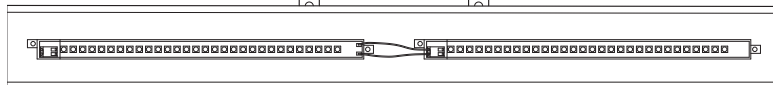
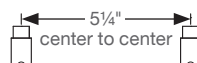

DZLEDZ24" shade
2700K, 90+ CRI, 9 Watt, 720 Lumen LED
Backplate: 4½" x 8"

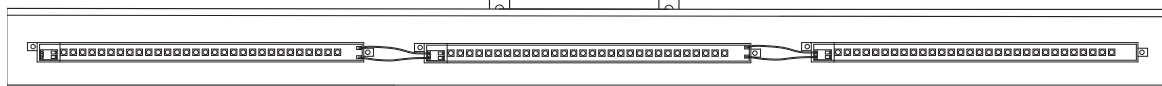
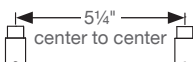

DZLEDZ36" shade
2700K, 90+ CRI, 13.5 Watts,
1080 Lumen LED
Backplate: 4½" x 8"

Picture Lights — Battery Operated



Sarah Gibson, Designer & Blogger, Room for Tuesday

BSLED24-91 (*Oil Rubbed Bronze*)

Battery operated picture lights are a great solution when it is impossible to get power to your picture light. Our battery-operated picture lights are LED, which use less power and give adequate illumination to light your art work for as long as 48 hours.

Battery Operated Advent Standard LED



ABLED14-61 (Antique Brass)

Features

- Operates on AA batteries (not included)
- Removable end caps for battery replacement
- Battery Life 36-48 hours
- No damaging UV
- Slide arm adjusts for horizontal extension
- Swivel at shade to adjust light
- Polished metal reflector in shade for maximum light output
- Mounts to frame or wall with included hardware

Size Selection Guide

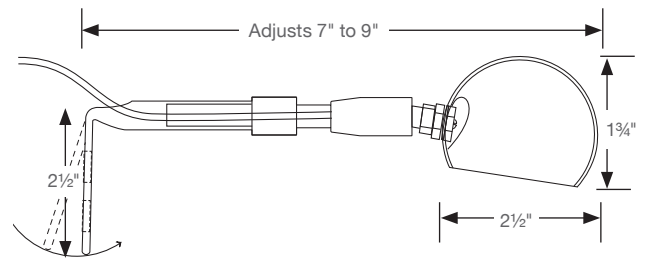
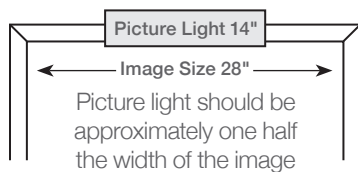

Finishes



Polished Brass #61

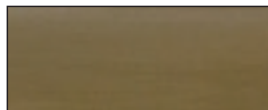

Antique Brass #71

Product Options:

ABLED7-61

ABLED7-71

ABLED14-61

ABLED14-71

Specifications

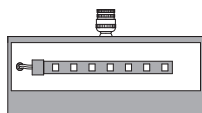

ABLED7"shade
3000K, 80 CRI, 1 Watt, 35 Lumens
Requires 4 AA batteries

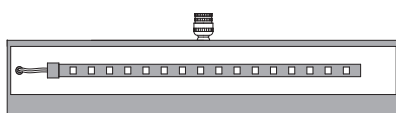

ABLED14"shade
3000K, 80 CRI, 2 Watts, 80 Lumens
Requires 8 AA batteries

Battery Operated Slim-Line™ LED

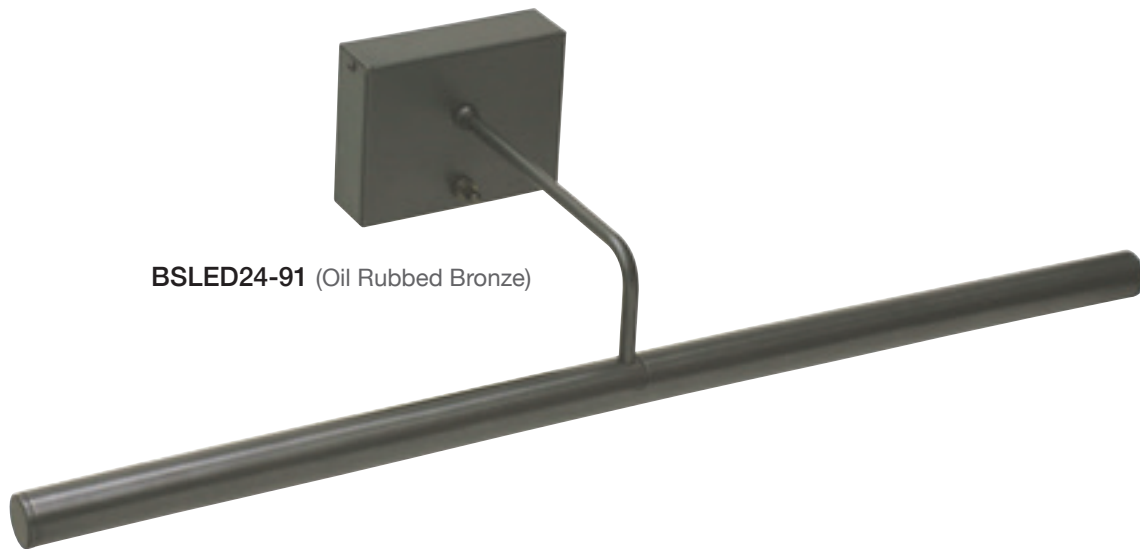

BSLED24-91 (Oil Rubbed Bronze)

Features

- Operates on four c-cell batteries (not included)
- Easy battery replacement in backplate
- Battery Life 36-48 hours
- No damaging UV
- 50,000 hour lifetime
- Swivel at shade to adjust light
- Polished metal reflector in shade for maximum light output

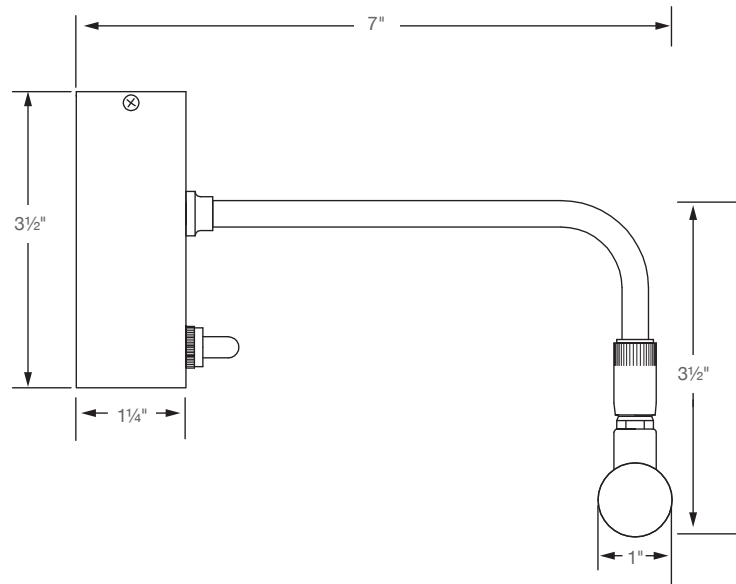

Size Selection Guide

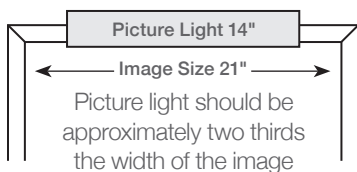

NOTE: When ordering a Battery Operated Slim-Line™ LED picture light note BSLED then the shade size followed by the finish code.

Finishes

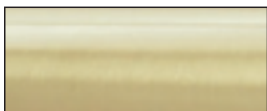

Satin Brass #51



Satin Nickel #52

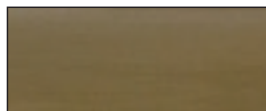

Antique Brass #71

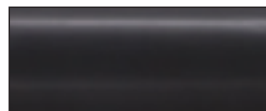

Oil Rubbed Bronze #91

Specifications

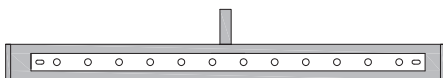

BSLED12" shade
3000K, 75 CRI, 1.6 Watt, 44 Lumen LED
Backplate: 4 1/2" x 3 1/2"

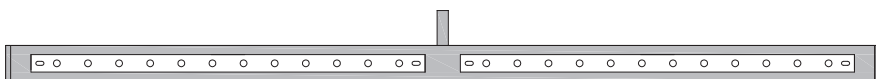

BSLED24" shade
3000K, 75 CRI, 3.2 Watt, 88 Lumen LED
Backplate: 4 1/2" x 3 1/2"

Battery Operated Traditional LED



Sarah Gibson, Designer & Blogger, Room for Tuesday

BTLED14-71 (*Antique Brass*)

Finishes



Gold #1



Satin Brass #51



Polished Brass #61

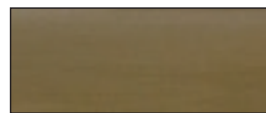

Antique Brass #71



Mahogany Bronze #81

Battery Operated Traditional LED

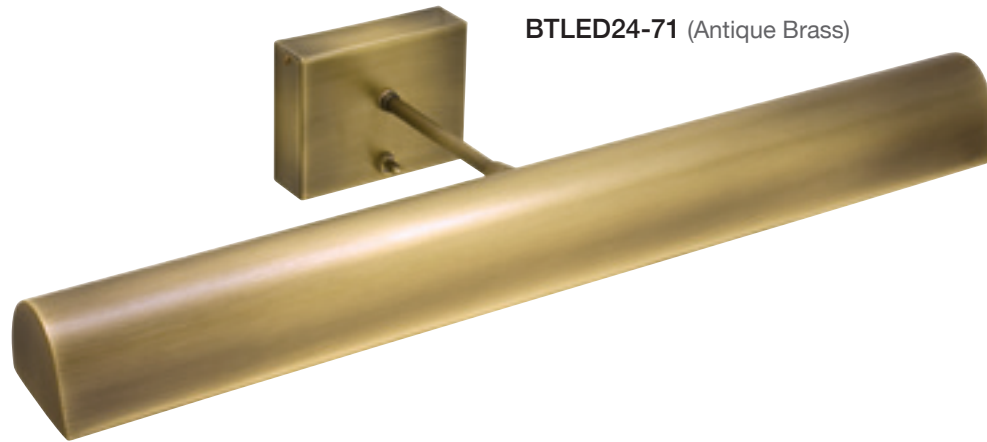

BTLED24-71 (Antique Brass)

Features

- Operates on four c-cell batteries (not included)
- Easy battery replacement in backplate
- Battery Life 36-48 hours
- No damaging UV
- 50,000 hour lifetime
- Swivel at shade to adjust light
- Polished metal reflector in shade for maximum light output

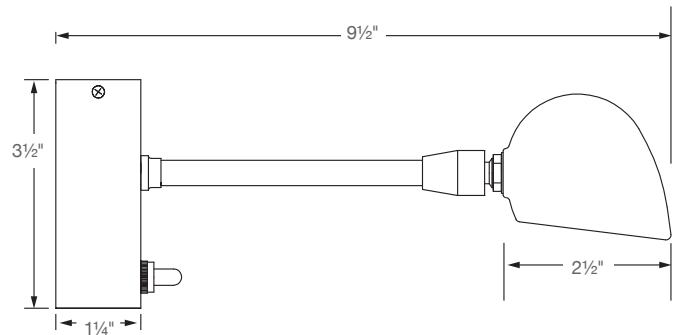

Size Selection Guide

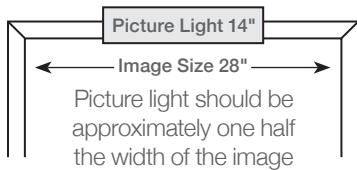

NOTE: When ordering a Battery Operated Traditional LED picture light note BTLED then the shade size followed by the finish code.

Specifications

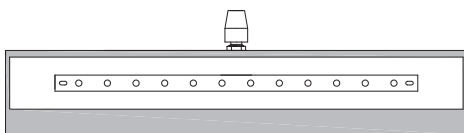

BTLED14" shade
3000K, 75 CRI, 1.6 Watt, 44 Lumen LED
Backplate: 4 1/2" x 3 1/2"

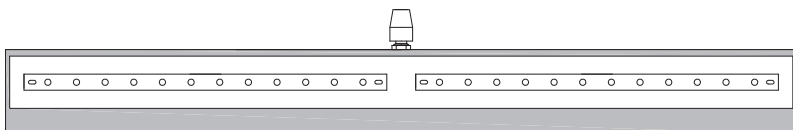

BTLED24" shade
3000K, 75 CRI, 3.2 Watt, 88 Lumen LED
Backplate: 4 1/2" x 3 1/2"

Floor, Table, and Wall Lamp Collections



House of Troy designs and builds portable lamps with task in mind. Integrated light sources, additional adjustability, and USB ports in bases add functionality to our product designs.

Addison



AD400-AB (*Antique Brass*)

Addison pharmacy lamps are classic metal shaded task lamps. Easy adjustment points offer multiple angles from which to focus light.



AD400-OB
Finish: Oil Rubbed Bronze



AD400-AB
Finish: Antique Brass

Fixture	Height	Extension	Base	Shade Material	Bulb	Shade Size
AD400-OB	adjusts 48" to 58"	27"	10"	metal	75W type A	5" x 8"
AD400-AB	adjusts 48" to 58"	27"	10"	metal	75W type A	5" x 8"
Cord: 10' brown cord Switch: on/off on socket						

Addison

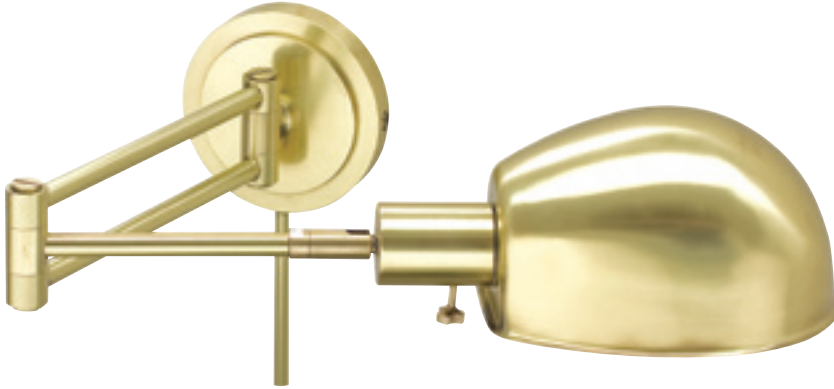

AD425-AB
Finish: Antique Brass



AD425-OB
Finish: Oil Rubbed Bronze

Fixture	Height	Extension	Backplate	Shade Material	Bulb	Shade Size
AD425-AB	5"	27"	5"	metal	75W type A	5" x 8"
AD425-OB	5"	27"	5"	metal	75W type A	5" x 8"

Cord: 10' clear cord with 30" cord cover
Switch: on/off on socket



AD450-AB
Finish: Antique Brass



AD450-OB
Finish: Oil Rubbed Bronze

Fixture	Height	Extension	Base	Shade Material	Bulb	Shade Size
AD450-OB	adjusts 24" to 32"	27"	8"	metal	75W type A	5" x 8"
AD450-AB	adjusts 24" to 32"	27"	8"	metal	75W type A	5" x 8"
Cord: 10' brown cord Switch: on/off on socket						

Alpine



A700-BLK/SN (*Black and Satin Nickel*)

American Made Alpine Collection floor lamps at their finest. Four 100W type A bulbs provide maximum light output in a clean, classic style floor lamp with a heavy weighted base. The crisp white shade tops off the sophisticated look of quality.



A750-BLK/SN
Finish: Black/Satin Nickel



A700-BLK/SN
Finish: Black/Satin Nickel



A750-AB/BLK
Finish: Antique Brass/Black



A700-AB/BLK
Finish: Antique Brass/Black

Fixture	Height	Depth	Base	Shade Material	Bulb	Shade Size	Shade Number
A700	64 $\frac{3}{4}$ "	15"	10"	fine white linen shade	four 100W type A	14" x 15" x 10"	40568N
A750	29 $\frac{3}{4}$ "	15"	8" with USB	fine white linen shade	four 100W type A	14" x 15" x 10"	40568N
Cord: 10' clear cord Switch: on/off top of column							

Alpine



A751-BLK/SS

Finish: Black/Supreme Silver



A701-BLK/SS

Finish: Black/Supreme Silver



A751-AB/HB

Finish: Antique Brass/
Hammered Bronze



A701-AB/HB

Finish: Antique Brass/
Hammered Bronze

Fixture	Height	Depth	Base	Shade Material	Bulb	Shade Size	Shade Number
A701	64 $\frac{3}{4}$ "	15"	10"	fine white linen shade	four 100W type A	14" x 15" x 10"	40568N
A751	29 $\frac{3}{4}$ "	15"	8" with USB	fine white linen shade	four 100W type A	14" x 15" x 10"	40568N
Cord: 10' clear cord Switch: on/off top of column							



A752-AB/BLK
Finish: Antique Brass/Black



A702-AB/BLK
Finish: Antique Brass/Black



A752-BLK/SN
Finish: Black/Satin Nickel



A702-BLK/SN
Finish: Black/Satin Nickel

Fixture	Height	Depth	Base	Shade Material	Bulb	Shade Size	Shade Number
A702	67"	15"	10"	fine white linen shade	four 100W type A	14" x 15" x 10"	40568N
A752	30½"	15"	8" with USB	fine white linen shade	four 100W type A	14" x 15" x 10"	40568N
Cord: 10' clear cord Switch: on/off top of column							

Andover



AN600-AB (*Antique Brass*)

The classic pharmacy floor lamp includes two adjustment clutches for maximum height adjustability. The sleek square base and rugged rectangle shade produces a new look for this antique brass lamp. Enjoy hours reading with the Andover Collection.



AN600-AB
Finish: Antique Brass

Fixture	Height	Extension	Base	Shade Material	Bulb	Shade Size
AN600-AB	Adjusts 45" to 52"	16"	10" x 10"	metal	60T-10	3" x 8"
<p>Cord: 10' brown cord exits adjustable arm Switch: on/off on socket</p>						

Aria



AR404WB/BLK (*Weathered Brass and Black*)

We now have a portable lamp that can move easily with whatever job you are performing. The clamp adjust onto any work station up to 2 $\frac{3}{8}$ " wide. The Aria Collection made in Vermont, has multiple finishes and takes up very little space. Great for the individual that is working from home.

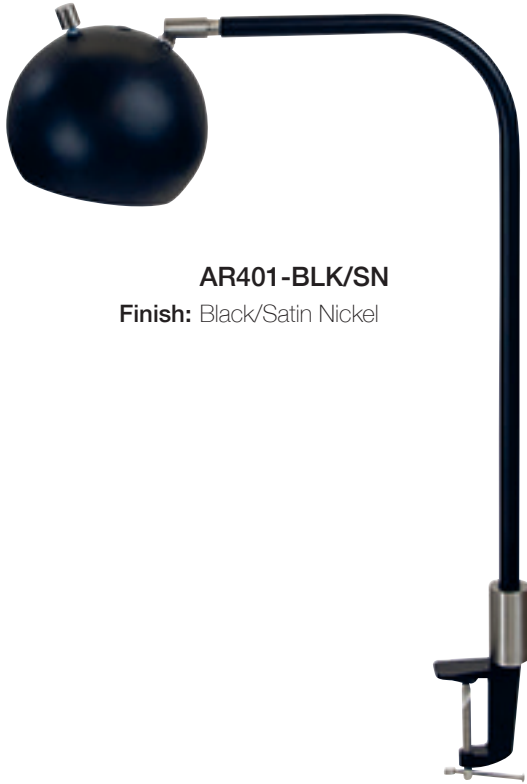

AR401-BLK/SN
Finish: Black/Satin Nickel

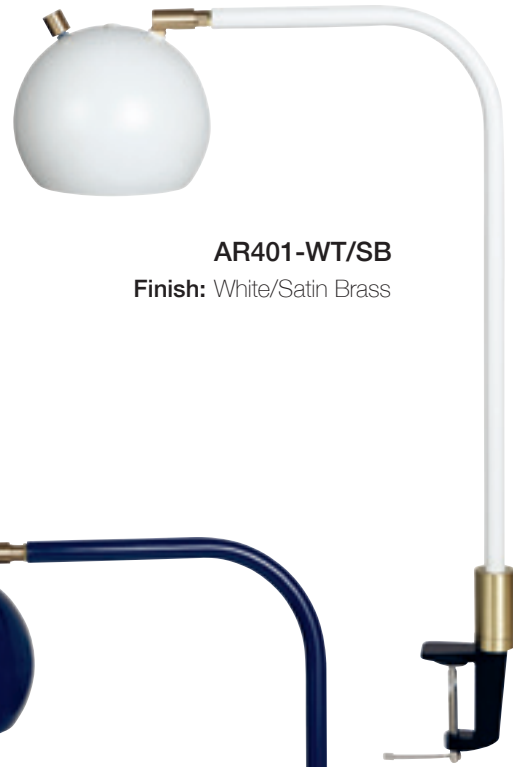

AR401-WT/SB
Finish: White/Satin Brass

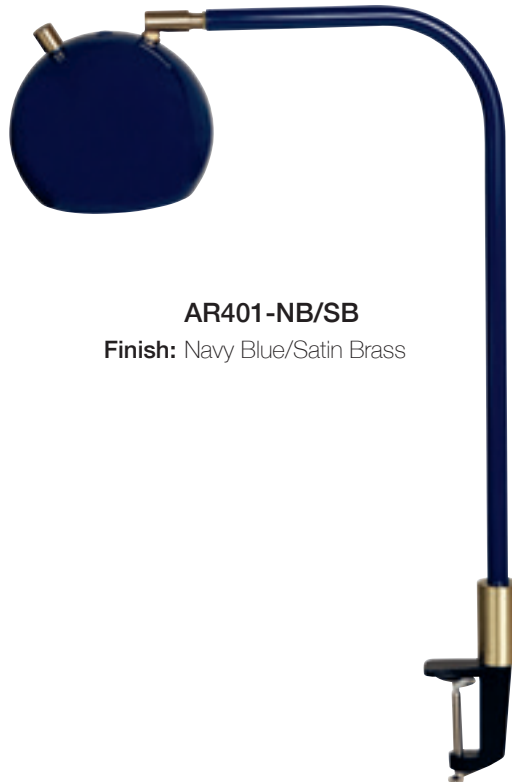

AR401-NB/SB
Finish: Navy Blue/Satin Brass



Actual Clamp

Fixture	Height	Depth	Base	Shade Material	Bulb	Shade Size
AR401-BLK/SN	20"	14½"	adj clamp (0-2¾")	metal	GU24-LED 2700K, 80 CRI, 11 watts, 1100 Lumens (included)	6" x 4½"
AR401-WT/SB	20"	14½"	adj clamp (0-2¾")	metal	GU24-LED 2700K, 80 CRI, 11 watts, 1100 Lumens (included)	6" x 4½"
AR401-NB/SB	20"	14½"	adj clamp (0-2¾")	metal	GU24-LED 2700K, 80 CRI, 11 watts, 1100 Lumens (included)	6" x 4½"
Cord: 10' clear cord Switch: full range dimmer on shade						

Aria



AR403-BLK/SN
Finish: Black/Satin Nickel



AR403-WT/SB
Finish: White/Satin Brass



AR403-NB/SB
Finish: Navy Blue/Satin Brass



Actual Clamp

Fixture	Height	Depth	Base	Shade Material	Bulb	Shade Size
AR403-BLK/SN	18½"	13½"	adj clamp (0-2¾")	metal	One 3000K 80+CRI 6.2 watt 600 lumen LED	2¼" × 4¼" × 5½"
AR403-WT/SB	18½"	13½"	adj clamp (0-2¾")	metal	One 3000K 80+CRI 6.2 watt 600 lumen LED	2¼" × 4¼" × 5½"
AR403-NB/SB	18½"	13½"	adj clamp (0-2¾")	metal	One 3000K 80+CRI 6.2 watt 600 lumen LED	2¼" × 4¼" × 5½"
Cord: 10' clear cord Switch: on/off on shade						



AR404-WB/BLK
Finish: Weathered Brass/Black



AR402-BLK/SN
Finish: Black/Satin Nickel



Actual Clamp

Fixture	Height	Depth	Base	Shade Material	Bulb	Shade Size	Switch	Shade Number
AR404-WB/BLK	16 ³ / ₄ "	14"	adj clamp (0-2 ³ / ₈ ")	black hardback	One 100W type A	5" x 7 ¹ / ₂ " x 6 ¹ / ₄ "	on/off on cord 6" from clamp	40275
AR403-BLK/SN	20 ¹ / ₄ "	15"	adj clamp (0-2 ³ / ₈ ")	fine white linen hardback	One 100W type A	9" x 9" x 10"	full range dimmer on socket	40543N
Cord: 10' clear cord								

Averill



AV101-OB (*Oil Rubbed Bronze*)

The Averill Collection is a beautiful American Made floor lamp. The twin-pull chains make it easy to turn your light on and off. Each chain operates a 100W type A bulb.



AV101-OB
Finish: Oil Rubbed Bronze



AV100-OB
Finish: Oil Rubbed Bronze

Fixture	Height	Depth	Base	Shade Material	Bulb	Shade Size	Shade Number
AV100-OB	adjusts 52" to 66"	17"	11"	off-white linen hardback	Two 100W Type A	15" x 17" x 10½"	40432
AV101-OB	adjusts 58" to 72"	23"	11"	off-white linen hardback	Two 100W Type A	15" x 17" x 10½"	40432
Cord: 10' brown Switch: twin pull							

Barton



BA700-CHB (*Chestnut Bronze*)

Hand stained wood produces a rugged outdoor look for these American Made lamps. The accent pieces help complete the strong look. The chestnut bronze powdercoat finish makes this a durable light you can enjoy for years. The Barton Collection is suitable for any room.



BA750-CHB

Finish: Chestnut Bronze with Oak and Satin Brass accents

BA700-CHB

Finish: Chestnut Bronze with Oak and Satin Brass accents



BA701-CHB

Finish: Chestnut Bronze with Oak and Satin Brass accents

Fixture	Height	Depth	Base	Shade Material	Bulb	Shade Size	Shade Number
BA750-CHB	29"	16"	8" with USB port	natural linen hardback	150W 3-way	11" x 16" x 11"	40497
BA700-CHB	65"	18"	10½"	natural linen hardback	150W 3-way	12" x 18" x 12"	40569
BA701-CHB	adjustable 42" to 57"	50"	10½"	metal	75W type A	9¾" diameter	
Cord: 10' brown Switch: on socket							

Brandon



BR102-OB (*Oil Rubbed Bronze*)

Are you looking for a floor lamp with a convenient USB port? These imported floor and table lamps all come equipped with a USB port. Simple design, quality product, available in oil rubbed bronze or satin nickel.



BR102-OB
Finish: Oil Rubbed Bronze



BR102-SN
Finish: Satin Nickel

Fixture	Height	Depth	Base	Table Height	Shade Material	Bulb	Shade Size	Cord	Shade Number
BR102-OB	58¾"	18"	10"	24" from floor with USB port	off-white linen shade	one 150W 3-way	17" x 18" x 12"	10' brown	40582
BR102-SN	58¾"	18"	10"	24" from floor with USB port	white linen shade	one 150W 3-way	17" x 18" x 12"	10' clear	40582W
Switch: on socket Table Height: 24"									

Brandon



BR150-OB

Finish: Oil Rubbed Bronze



BR150-SN

Finish: Satin Nickel

Fixture	Height	Depth	Base	Shade Material	Bulb	Shade Size	Cord	Shade Number
BR150-OB	28"	15"	8" with USB port	off-white linen shade	100W type A	14" x 15" x 10"	10' brown	40428
BR150-SN	28"	15"	8" with USB port	white linen shade	100W type A	14" x 15" x 10"	10' clear	40428W
Switch: rocker switch on base								



B205-SB (*Satin Brass*)

Customers ask for it and we've got it. Petite American Made table lamps in a variety of styles. Heights range from 11 to 13 inches tall. The Bryson Collection works in any small area that requires some additional light.

Bryson



B201-SN

Finish: Satin Nickel



B208-SB/NB

Finish: Satin Brass/Navy Blue



B203-BLK/SN

Finish: Black/Satin Nickel



B207-BLK/SB

Finish: Black/Satin Brass



B202-AB

Finish: Antique Brass

Fixture	Height	Depth	Base	Shade Material	Bulb	Shade Size	Shade Number
B201-SN	12½"	6"	5"	white linen hardback shade	one 60WB10	4" x 6" x 6"	40215W
B202-AB	11¾"	6"	5"	natural linen hardback shade	one 60WB10	4" x 6" x 6"	40216N
B203-BLK/SN	12"	6"	5"	white linen hardback shade	one 60WB10	4" x 6" x 6"	40215W
B207-BLK/SB	12"	6"	5"	natural linen hardback shade	one 60WB10	4" x 6" x 6"	40216N
B208-SB/NB	12¾"	7¼"	5"	off-white linen shade	one 60WB10	4" x 7¼" x 6"	40210
Cord: 10' clear Switch: on/off on cord 6" from the base							

Bryson



B204-SN
Finish: Satin Nickel



B205-SB
Finish: Satin Brass



B209-SN/BLK
Finish: Satin Nickel/Black



B210-BLK/AB
Finish: Black/Antique Brass



B206-SB
Finish: Satin Brass

Fixture	Height	Depth	Base	Shade Material	Bulb	Shade Size	Shade Number
B204-SN	12¾"	6"	5"	white linen hardback shade	one 60WB10	4" x 6" x 6"	40215W
B205-SB	13½"	5"	5"	cream linen hardback shade	one 60WB10	4½" x 4½" x 6"	40214C
B206-SB	12¾"	6"	5"	natural linen hardback shade	one 60WB10	4" x 6" x 6"	40216N
B209-SN/BLK	12½"	6"	5"	white linen hardback shade	one 60WB10	4" x 6" x 6"	40215W
B210-BLK/AB	12½"	6"	5"	white linen hardback shade	one 60WB10	4" x 7¼" x 6"	40215W

Cord: 10' clear
Switch: on/off on cord 6" from the base

Cavendish



Savannah Brown Photography on location at Field Guide, Stowe VT

C350-WB/WT (*Weathered Brass and White*)

Cavendish floor and table lamps in mixed metal finishes are a nod to the mid-century modern genre with distinctly twenty first century integrated LED light output. Made in Vermont with pride.

C300-WB/BLK
Finish: Weathered Brass
 with Black Accents



C300-WB/WT
Finish: Weathered Brass
 with White Accents

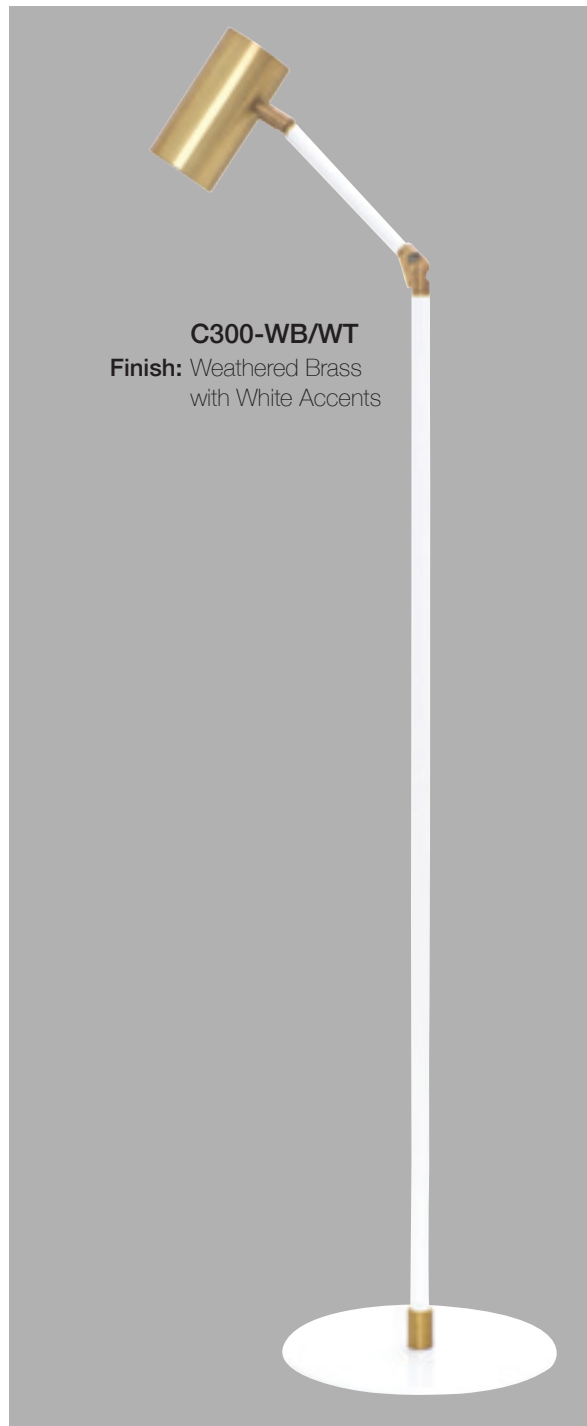

Fixture	Height	Extension	Base	Shade Material	Bulb	Shade Size
C300-WB/BLK	adjusts 42" to 55½"	12"	11"	metal	Integrated 3000K, 80 CRI, 6 Watts, 500 Lumens	3" x 5¾"
C300-WB/WT	adjusts 42" to 55½"	12"	11"	metal	Integrated 3000K, 80 CRI, 6 Watts, 500 Lumens	3" x 5¾"

Cord: 10' clear with plug-in driver
Switch: touch dimmer on shade

Cavendish



C350-WB/BLK

Finish: Weathered Brass with Black Accents



C350-WB/WT

Finish: Weathered Brass with White Accents

Fixture	Height	Extension	Base	Shade Material	Bulb	Shade Size
C350-WB/BLK	21"	13½"	8"	metal	Integrated 3000K, 80 CRI, 6 Watts, 500 Lumens	3" × 5¼"
C350-WB/WT	21"	13½"	8"	metal	Integrated 3000K, 80 CRI, 6 Watts, 500 Lumens	3" × 5¼"
Cord: 10' Clear with Plug-in Driver Switch: touch dimmer on shade						



CL202-OB (*Oil Rubbed Bronze*)

The Club lamps, of petite stature, are perfect for small spaces.
The classic style will look great in any traditional setting.

Club



CL200-OB
Finish: Oil Rubbed Bronze



CL200-AB
Finish: Antique Brass



CL200-AS
Finish: Antique Silver

Fixture	Height	Extension	Base	Shade Material	Bulb	Shade Size	Cord	Shade Number
CL200-OB	adjusts 45" to 59"	19½"	12"	off-white softback	one 100W 3-way	6½" × 13" × 10"	10' brown	40417
CL200-AS	adjusts 45" to 59"	19½"	12"	white softback	one 100W 3-way	6½" × 13" × 10"	10' clear	40418
CL200-AB	adjusts 45" to 59"	19½"	12"	off-white softback	one 100W 3-way	6½" × 13" × 10"	10' brown	40417
Switch: on socket								



CL201-BLK
Finish: Black



CL201-AS
Finish: Antique Silver



CL201-AB
Finish: Antique Brass



CL201-OB
Finish: Oil Rubbed Bronze

Fixture	Height	Depth	Base	Shade Material	Bulb	Shade Size	Cord	Shade Material
CL201-AS	adjusts 45" to 59"	13"	12"	white softback	one 100W 3-way	6½" × 13" × 10"	10' clear	40418
CL201-OB	adjusts 45" to 59"	13"	12"	off-white softback	one 100W 3-way	6½" × 13" × 10"	10' brown	40417
CL201-AB	adjusts 45" to 59"	13"	12"	off-white softback	one 100W 3-way	6½" × 13" × 10"	10' brown	40417
CL201-BLK	adjusts 45" to 59"	13"	12"	white softback	one 100W 3-way	6½" × 13" × 10"	10' brown	40418BLK
Switch: on socket								



CL202-OB
Finish: Oil Rubbed Bronze



CL202-AB
Finish: Antique Brass

Fixture	Height	Depth	Base	Shade Material	Bulb	Shade Size	Shade Number
CL202-OB	adjusts 45" to 59"	13"	10"	off-white softback	one 100W 3-way	6½" × 13" × 10"	40417
CL202-AB	adjusts 45" to 59"	13"	10"	off-white softback	one 100W 3-way	6½" × 13" × 10"	40417
Cord: 10' brown Switch: on socket Table: 12" diameter, height 24"							

Cover plate provided for standard junction box when necessary, as shown on CL225-AB.



CL225-OB
Finish: Oil Rubbed Bronze



CL225-AB
Finish: Antique Brass

Fixture	Height	Extension	Backplate	Shade Material	Bulb	Shade Size	Shade Number
CL225-OB	17¾"	20½"	2¾" x 5¾"	off-white softback	one 100W 3-way	6½" x 13" x 10"	40417
CL225-AB	17¾"	20½"	2¾" x 5¾"	off-white softback	one 100W 3-way	6½" x 13" x 10"	40417
Cord: 10' clear with 30" cord cover Switch: on socket							

Club



CL250-AS
Finish: Antique Silver



CL250-AB
Finish: Antique Brass



CL250-OB
Finish: Oil Rubbed Bronze

Fixture	Height	Depth	Base	Shade Material	Bulb	Shade Size	Cord	Shade Number
CL250-OB	adjusts 27" to 32"	13"	7"	off-white softback	one100W 3-way	6½" × 13" × 10"	10' brown	40417
CL250-AB	adjusts 27" to 32"	13"	7"	off-white softback	one100W 3-way	6½" × 13" × 10"	10' brown	40417
CL250-AS	adjusts 27" to 32"	13"	7"	white softback	one100W 3-way	6½" × 13" × 10"	10' clear	40418
Switch: on socket								



CL251-AB
Finish: Antique Brass



CL251-AS
Finish: Antique Silver

Fixture	Height	Extension	Base	Shade Material	Bulb	Shade Size	Cord	Shade Number
CL251-AB	28"	19½"	7"	off-white softback	one100W 3-way	6½" × 13" × 10"	10' brown	40417
CL251-AS	28"	19½"	7"	white softback	one100W 3-way	6½" × 13" × 10"	10' clear	40418
Switch: on socket								

Coach



CH825-OB (*Oil Rubbed Bronze*)

Our imported Coach Collection offers the best quality lamp for a good price. The lamp and shade are packed in a single box for easy shipping.



CH800-AB
Finish: Antique Brass



CH800-OB
Finish: Oil Rubbed Bronze

Fixture	Height	Depth	Base	Shade Material	Bulb	Shade Size	Cord	Shade Number
CH800-AB	61"	16"	10"	off-white silk softback	One 150W 3-way	15" x 16" x 10"	10' gold	40510
CH800-OB	61"	16"	10"	off-white silk softback	One 150W 3-way	15" x 16" x 10"	10' brown	40510

Switch: on socket



CH825-AB
Finish: Antique Brass



CH825-OB
Finish: Oil Rubbed Bronze



CH825-AS
Finish: Antique Silver

Fixture	Height	Extension	Base	Shade Material	Bulb	Shade Size	Cord
CH825-AB	adjusts 35½" to 52½"	14"	10"	metal	one 60W Type A	7" x 4" x 3¼"	10' gold
CH825-OB	adjusts 35½" to 52½"	14"	10"	metal	one 60W Type A	7" x 4" x 3¼"	10' brown
CH825-AS	adjusts 35½" to 52½"	14"	10"	metal	one 60W Type A	7" x 4" x 3¼"	10' silver
Cord: exits from adjustment arm Switch: on/off on socket							



CH850-OB
Finish: Oil Rubbed Bronze



CH850-AB
Finish: Antique Brass

Fixture	Height	Depth	Base	Shade Material	Bulb	Shade Size	Cord	Shade Number
CH850-AB	30¼"	15"	8"	off-white silk softback	one 150W 3-way	14" x 15" x 10"	10' gold	40512
CH850-OB	30¼"	15"	8"	off-white silk softback	one 150W 3-way	14" x 15" x 10"	10' brown	40512

Switch: on socket

Coach



CH876-AB
Finish: Antique Brass



CH878-AB
Finish: Antique Brass



CH880-OB
Finish: Oil Rubbed Bronze



CH875-OB
Finish: Oil Rubbed Bronze

Fixture	Height	Depth	Base	Shade Material	Bulb	Shade Size	Cord	Shade Number
CH876-AB	12½"	10"	6" x 4"	off-white hardback	one 60W Type A	(6" x 4") x (10" x 6") x 7"	10' gold	40518
CH880-OB	15"	8"	6" x 4"	off-white hardback	two 60W-B10 candelabra	(4" x 6") x (8" x 6") x 6"	10' brown	40522
CH878-AB	12"	6"	4¾"	off-white hardback	two 60W-B10 candelabra	4" x 6" x 6"	10' gold	40520A
CH875-OB	14"	9"	5¼"	off-white hardback	one 60W Type A	6" x 9" x 7"	10' brown	40517
Switch: in-line 9" from base								

Crown Point



CR700-AB (*Antique Brass*)

The Crown Point series allows for height adjustment and a swing arm. The down-bridge style shade is great for focusing light on your task.

Crown Point



CR700-AB
Finish: Antique Brass



CR700-OB
Finish: Oil Rubbed Bronze

Fixture	Height	Extension	Base	Shade Material	Bulb	Shade Size	Shade Number
CR700-AB	adjusts 38" to 63"	18"	10"	off-white linen hardback	100W 3-way	10" x 12" x 8"	40411
CR700-OB	adjusts 38" to 63"	18"	10"	off-white linen hardback	100W 3-way	10" x 12" x 8"	40511N
Cord: 10' brown cord exits adjustment arm Switch: on socket							

Crown Point

Plug-In Only



CR725-AB
Finish: Antique Brass



CR725-OB
Finish: Oil Rubbed Bronze



CR725-SN
Finish: Satin Nickel

Fixture	Height	Extension	Backplate	Shade Material	Bulb	Shade Size	Shade Number
CR725-OB	adjusts 8" to 18"	18"	4½" × 6½"	off-white linen hardback	100W 3-way	10" × 12" × 8"	40411
CR725-AB	adjusts 8" to 18"	18"	4½" × 6½"	off-white linen hardback	100W 3-way	10" × 12" × 8"	40411
CR725-SN	adjusts 8" to 18"	18"	4½" × 6½"	white linen hardback	100W 3-way	10" × 12" × 8"	40411N
Cord: 8' clear Switch: on socket							

Delta



D100-SN (*Satin Nickel*)

A classic reading light with a solid-state LED light source.
The American Made Delta series packs a lot of light into a small
shade. Easy dimmable switching on shade.



D100-AB
Finish: Antique Brass



D100-OB
Finish: Oil Rubbed Bronze



D100-SN
Finish: Satin Nickel

Fixture	Height	Extension	Base	Shade Material	LED	Shade Size
D100-AB	adjusts 37½" to 49½"	20"	10"	metal	Integrated 3000K, 80 CRI, 6 Watts, 500 Lumens	2" x 4"
D100-OB	adjusts 37½" to 49½"	20"	10"	metal	Integrated 3000K, 80 CRI, 6 Watts, 500 Lumens	2" x 4"
D100-SN	adjusts 37½" to 49½"	20"	10"	metal	Integrated 3000K, 80 CRI, 6 Watts, 500 Lumens	2" x 4"
<p>Cord: 10' clear with plug-in driver Switch: touch dimmer on shade</p>						

Delta



D150-AB
Finish: Antique Brass



D150-OB
Finish: Oil Rubbed Bronze



D150-SN
Finish: Satin Nickel

Fixture	Height	Extension	Base	Shade Material	LED	Shade Size
D150-OB	18"	21¼"	7"	metal	Integrated 3000K, 80 CRI, 6 Watts, 500 Lumens	2" x 4"
D150-AB	18"	21¼"	7"	metal	Integrated 3000K, 80 CRI, 6 Watts, 500 Lumens	2" x 4"
D150-SN	18"	21¼"	7"	metal	Integrated 3000K, 80 CRI, 6 Watts, 500 Lumens	2" x 4"
Cord: 10' clear with plug-in driver Switch: touch dimmer on shade						

Plug-in Only



D175-AB
Finish: Antique Brass



D175-OB
Finish: Oil Rubbed Bronze



D175-SN
Finish: Satin Nickel

Fixture	Height	Extension	Backplate	Shade Material	LED	Shade Size
D175-AB	5½"	21¼"	5½"	metal	Integrated 3000K, 80 CRI, 6 Watts, 500 Lumens	2" x 4"
D175-OB	5½"	21¼"	5½"	metal	Integrated 3000K, 80 CRI, 6 Watts, 500 Lumens	2" x 4"
D175-SN	5½"	21¼"	5½"	metal	Integrated 3000K, 80 CRI, 6 Watts, 500 Lumens	2" x 4"

Cord: 10' clear with plug-in driver, with 30" cord cover
Switch: touch dimmer on shade

Fairfax



F100-OB (*Oil Rubbed Bronze*)

The base on the Fairfax pharmacy lamp is flat and narrow, meant to be tucked under a couch or bed. Height adjustment offers flexibility for light placement.

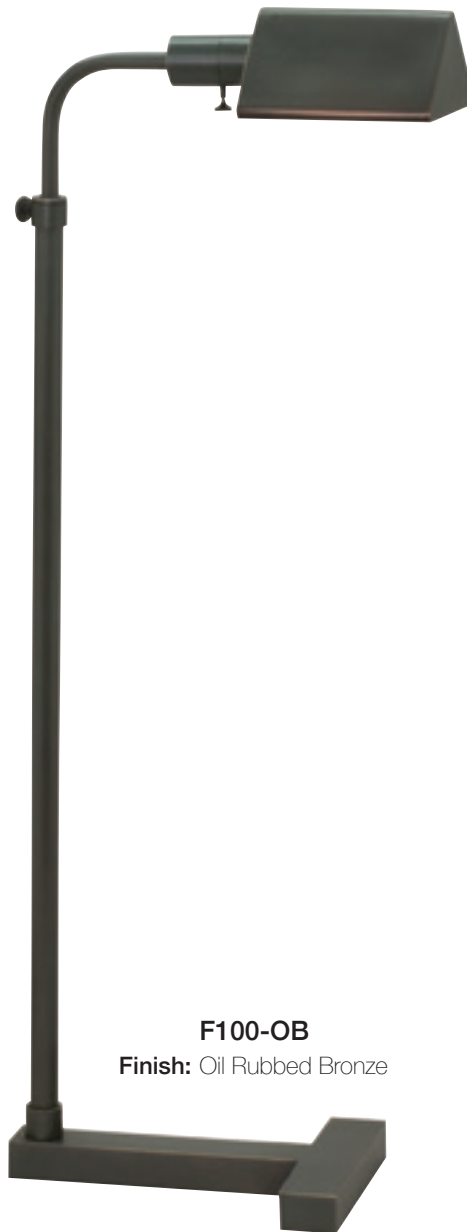
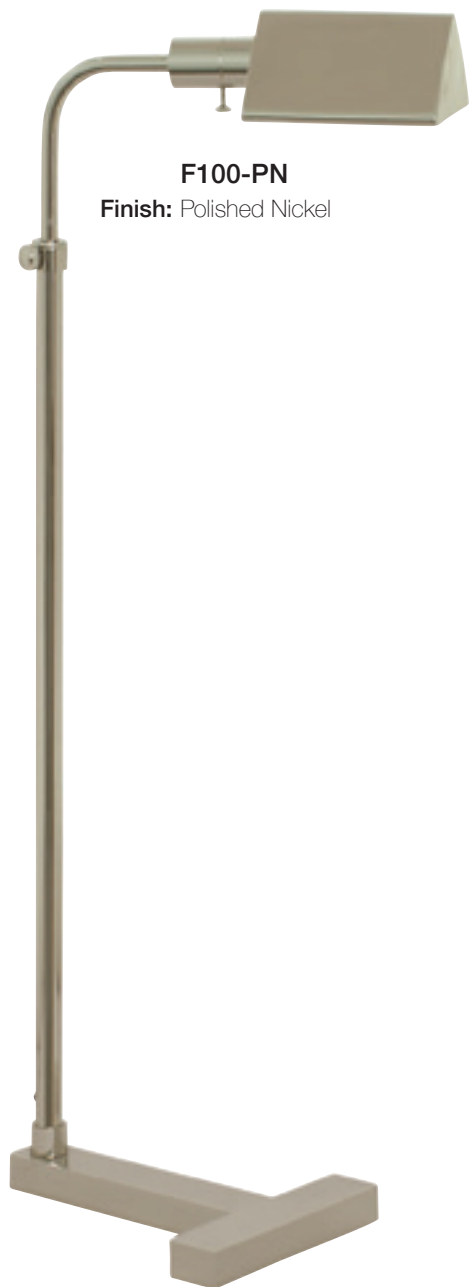

Fixture	Height	Extension	Base	Shade Material	Bulb	Shade Size	Cord
F100-PN	adjusts 36" to 53"	13½"	9" × 12" × 1¾"	metal	100W Type A	6½" × 3" × 6"	10' clear
F100-OB	adjusts 36" to 53"	13½"	9" × 12" × 1¾"	metal	100W Type A	6½" × 3" × 6"	10' brown
F100-AB	adjusts 36" to 53"	13½"	9" × 12" × 1¾"	metal	100W Type A	6½" × 3" × 6"	10' brown
Switch: on/off on shade							

Farmhouse



FH300-CHB (*Chestnut Bronze*)

The American Made Farmhouse collection features wood accents and industrial components. This family of floor, table and wall swing lamps create lighting for any room.

Farmhouse



FH350-CHB
Finish: Chestnut Bronze with Burned Wood Accents



FH300-CHB
Finish: Chestnut Bronze with Burned Wood Accents



FH301-CHB
Finish: Chestnut Bronze with Burned Wood accents



FH375-CHB
Finish: Chestnut Bronze with Burned Wood Accents

Fixture	Height	Depth/Extension	Base/Backplate	Shade Material	Bulb	Shade Size	Cord	Shade Number
FH350-CHB	28"	15"	7" x 7"	off-white burlap hardback	one 150W 3-way	11" x 15" x 10"	10' brown	40556
FH300-CHB	60½"	18"	10" x 10"	off-white burlap hardback	one 150W 3-way	16" x 18" x 11"	10' brown	40556A
FH375-CHB	17"	23"	4½" x 4½"	off-white burlap hardback	one 150W 3-way	11" x 15" x 10"	8' ivory with 30" cord cover	40556
FH301-CHB	60"	20"	10" x 10"	burlap hardback	150W 3-way	11" x 15" x 10"	10' brown	40556
Switch: on socket								

Franklin



FR701-OB (*Oil Rubbed Bronze*)

Diffused light and full range dimming are features of the Franklin series. The table lamp is offered with a USB port for easy charging access.



FR700-OB
Finish: Oil Rubbed Bronze



FR701-OB
Finish: Oil Rubbed Bronze

Fixture	Height	Extension	Base	Shade Material	Bulb	Shade Size	Shade Number
FR700-OB	64"	19½"	10"	off-white linen hardback	150W Type A	19" × 19½" × 10" with diffuser	40436
FR701-OB	60"	25½"	10"	off-white linen hardback	150W Type A	15" × 15½" × 7½" with diffuser	40435
Cord: 10' brown Switch: full range dimmer on column							

Franklin



FR750-OB
Finish: Oil Rubbed Bronze



FR750-PN
Finish: Polished Nickel

Fixture	Height	Depth	Base	Shade Material	Bulb	Shade Size	Cord	Shade Number
FR750-OB	27"	15½"	7" with USB port	off-white linen hardback	150W Type A	15" × 15½" × 7½" with diffuser	11' brown	40435
FR750-PN	27"	15½"	7" with USB port	white linen hardback	150W Type A	15" × 15½" × 7½" with diffuser	11' clear	40435N

Switch: full range dimmer



FN100-NB/SB (*Navy Blue and Satin Brass*)

This American Made Fusion floor, table and wall swing family provide extreme movement with the gooseneck arm. These lamps can be angled in a variety of positions. We powdercoat the column and shade so custom finishes are available. The table lamp includes a USB port.

Fusion



FN100-BLK/SN
Finish: Black/Satin Nickel



FN175-BLK/SN
Finish: Black/Satin Nickel



FN150-BLK/SN
Finish: Black/Satin Nickel

Fixture	Height	Depth	Base	Shade Material	Bulb	Shade Size	Cord
FN100-BLK/SN	52¼"	22½"	10"	metal	one 60T-10	11½"	10' clear
FN150-BLK/SN	16"	17"	7" with USB	metal	one LED5W included 3000K 90+CRI 5watt 545 lumen	7½"	10' clear
FN175-BLK/SN	5"-10"	19¾"	5"	metal	one LED5W included 3000K 90+CRI 5watt 545 lumen	7½"	10' ivory cord with 30" cord cover
Switch: full range dimmer on shade							

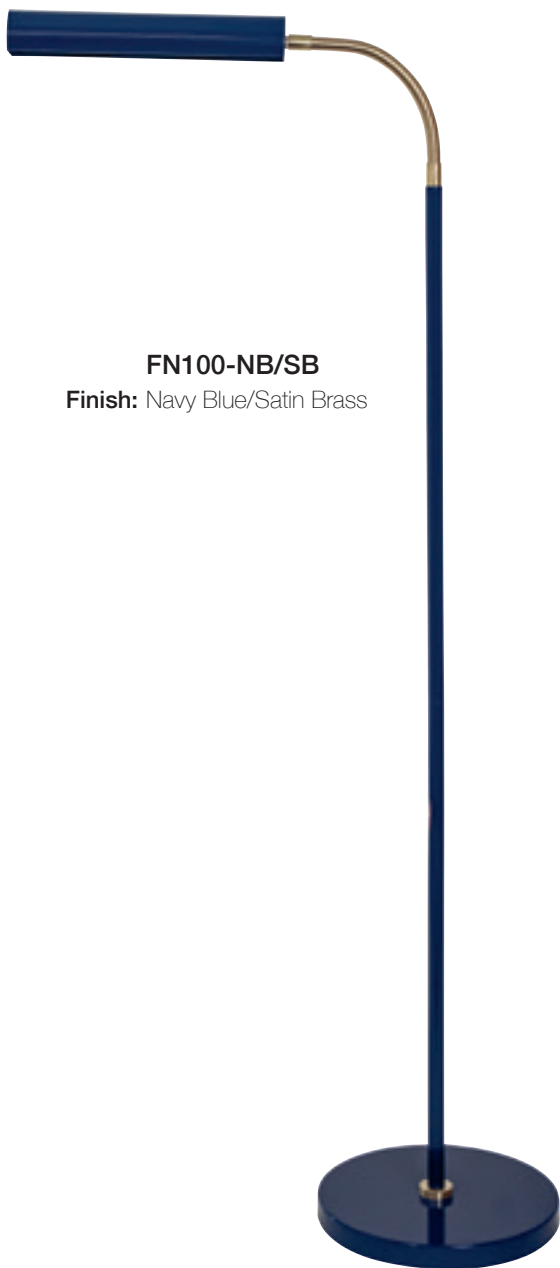

FN100-NB/SB
Finish: Navy Blue/Satin Brass



FN175-NB/SB
Finish: Navy Blue/Satin Brass



FN150-NB/SB
Finish: Navy Blue/Satin Brass

Fixture	Height	Depth	Base	Shade Material	Bulb	Shade Size	Cord
FN100-NB/SB	52¼"	22½"	10"	metal	one 60T-10	11½"	10' clear
FN150-NB/SB	16"	17"	7" with USB	metal	one LED5W included 3000K 90+CRI 5watt 545 lumen	7½"	10' clear
FN175-NB/SB	5"-10"	19¾"	5"	metal	one LED5W included 3000K 90+CRI 5watt 545 lumen	7½"	10' ivory cord with 30" cord cover
Switch: full range dimmer on shade							

Generation 1



G100-GT (*Granite*)

The American Made Generation 1 halogen series of pharmacy lamps use a GU10 encapsulated halogen bulb and are fully dimmable. These powder coated lamps are durable and adjustable.

Generation 1



Fixture	Height	Extension	Base	Shade Material	Bulb	Shade Size	Cord
G100-GT	adjusts 32½" to 45"	11"	10"	metal	one 50W GU10 (included)	6½" × 1½"	10' black
G100-CHB	adjusts 32½" to 45"	11"	10"	metal	one 50W GU10 (included)	6½" × 1½"	10' brown
G100-WT	adjusts 32½" to 45"	11"	10"	metal	one 50W GU10 (included)	6½" × 1½"	10' white
Switch: full range dimmer on socket							

Generation 2



G200-GT (*Granite*)

The American Made Generation 2 fabric shaded incandescent table and floor models are controlled with a full range dimmer on the socket.

Generation 2



G200-CHB
Finish: Chestnut Bronze



G200-GT
Finish: Granite

Fixture	Height	Extension	Base	Shade Material	Bulb	Shade Size	Cord	Shade Number
G200-CHB	adjusts 47" to 60"	15¼"	10"	off-white linen	one 150W Type A	11" × 13" × 9"	10' brown	40469
G200-GT	adjusts 47" to 60"	15¼"	10"	white linen	one 150W Type A	11" × 13" × 9"	10' black	40468

Switch: full range dimmer on socket

Generation 2



G250-CHB
Finish: Chestnut Bronze



G250-GT
Finish: Granite

Fixture	Height	Depth	Base	Shade Material	Bulb	Shade Size	Cord	Shade Number
G250-CHB	25¾"	11½"	6"	off-white linen hardback	one 150W Type A	8½" × 11½" × 9"	10' brown	40471
G250-GT	25¾"	11½"	6"	white linen hardback	one 150W Type A	8½" × 11½" × 9"	10' black	40470
Switch: full range dimmer on socket								

Generation 3



G300-BLK (*Black*)

The American Made Generation 3 uses a linear LED configuration for optimal light output. A small footprint on the floor base makes this a great choice for small spaces.

Generation 3



G300-BLK
Finish: Black

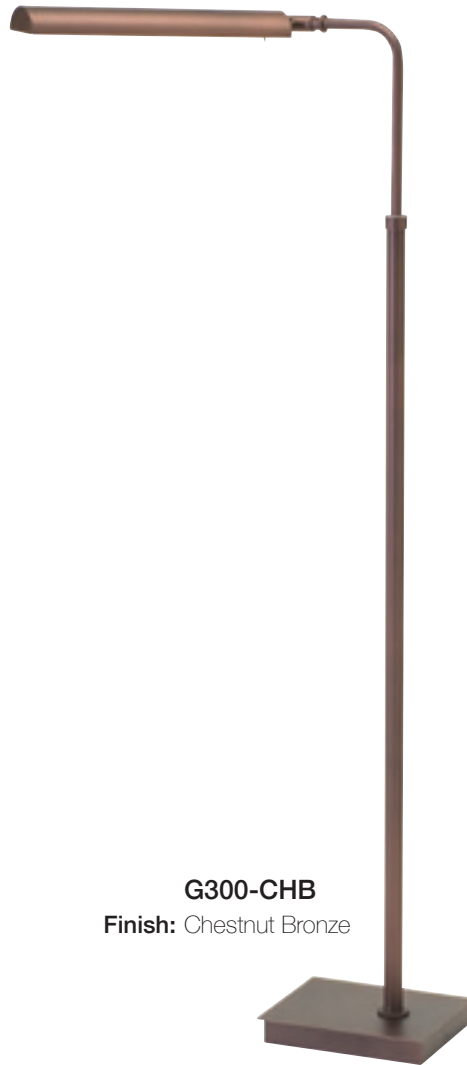

G300-CHB
Finish: Chestnut Bronze



G300-GT
Finish: Granite

Fixture	Height	Extension	Base	Shade Material	LED	Shade Size	Cord
G300-BLK	adjusts 37" to 46½"	17"	6" x 7¼"	metal	Integrated 3000K, 85 CRI, 4.5 Watts, 500 Lumens	11¼" x ¾"	10' black
G300-CHB	adjusts 37" to 46½"	17"	6" x 7¼"	metal	Integrated 3000K, 85 CRI, 4.5 Watts, 500 Lumens	11¼" x ¾"	10' brown
G300-GT	adjusts 37" to 46½"	17"	6" x 7¼"	metal	Integrated 3000K, 85 CRI, 4.5 Watts, 500 Lumens	11¼" x ¾"	10' black
Switch: on/off on shade							

Generation 3



Fixture	Height	Extension	Base	Shade Material	LED	Shade Size	Cord
G350-GT	maximum 22"	35"	6" x 7¼"	metal	Integrated 3000K, 85 CRI, 4.5 Watts, 500 Lumens	11¼" x ¾"	10' black
G350-CHB	maximum 22"	35"	6" x 7¼"	metal	Integrated 3000K, 85 CRI, 4.5 Watts, 500 Lumens	11¼" x ¾"	10' brown
G350-BLK	maximum 22"	35"	6" x 7¼"	metal	Integrated 3000K, 85 CRI, 4.5 Watts, 500 Lumens	11¼" x ¾"	10' black
Switch: on/off on shade							

Generation 3

G375-CHB
Finish: Chestnut Bronze



G375-BLK
Finish: Black



G375-GT
Finish: Granite



Fixture	Height	Extension	Backplate	Shade Material	LED	Shade Size
G375-CHB	5"	24½"	5" x 5"	metal	Integrated 3000K, 85 CRI, 4.5 Watts, 500 Lumens	11¼" x ¾"
G375-BLK	5"	24½"	5" x 5"	metal	Integrated 3000K, 85 CRI, 4.5 Watts, 500 Lumens	11¼" x ¾"
G375-GT	5"	24½"	5" x 5"	metal	Integrated 3000K, 85 CRI, 4.5 Watts, 500 Lumens	11¼" x ¾"
Cord: 10' ivory with 30" cord cover Switch: on/off on shade						



Savannah Brown Photography on location at Field Guide, Stowe VT

G400-BS (*Bittersweet*)

The American Made Generation 4 LED series uses chip on board (COB) technology and touch dimming controls. COB's are wide area light emitters, providing better color mixing and lighting effect.

Generation 4



Fixture	Height	Extension	Base	Shade Material	LED	Shade Size
G400-ABZ	adjusts 37" to 48"	15½"	10"	metal	Integrated 3000K, 80 CRI, 6 Watts, 500 Lumens	4" × 1⅜"
G400-BLK	adjusts 37" to 48"	15½"	10"	metal	Integrated 3000K, 80 CRI, 6 Watts, 500 Lumens	4" × 1⅜"
G400-BS	adjusts 37" to 48"	15½"	10"	metal	Integrated 3000K, 80 CRI, 6 Watts, 500 Lumens	4" × 1⅜"
G400-GT	adjusts 37" to 48"	15½"	10"	metal	Integrated 3000K, 80 CRI, 6 Watts, 500 Lumens	4" × 1⅜"
Cord: 10' clear with plug-in driver Switch: touch dimmer on shade						

Generation 4



Fixture	Height	Extension	Base	Shade Material	LED	Shade Size
G400-NB	adjusts 37" to 48"	15½"	10"	metal	Integrated 3000K, 80 CRI, 6 Watts, 500 Lumens	4" × 1¾"
G400-PG	adjusts 37" to 48"	15½"	10"	metal	Integrated 3000K, 80 CRI, 6 Watts, 500 Lumens	4" × 1¾"
G400-WT	adjusts 37" to 48"	15½"	10"	metal	Integrated 3000K, 80 CRI, 6 Watts, 500 Lumens	4" × 1¾"
<p>Cord: 10' clear with plug-in driver Switch: touch dimmer on shade</p>						

Generation 4



Fixture	Height	Extension	Base	Shade Material	LED	Shade Size
G450-BS	adjusts 11" to 16½"	22"	7" with USB port	metal	Integrated 3000K, 80 CRI, 6 Watts, 500 Lumens	4" × 1⅜"
G450-BLK	adjusts 11" to 16½"	22"	7" with USB port	metal	Integrated 3000K, 80 CRI, 6 Watts, 500 Lumens	4" × 1⅜"
G450-GT	adjusts 11" to 16½"	22"	7" with USB port	metal	Integrated 3000K, 80 CRI, 6 Watts, 500 Lumens	4" × 1⅜"
G450-ABZ	adjusts 11" to 16½"	22"	7" with USB port	metal	Integrated 3000K, 80 CRI, 6 Watts, 500 Lumens	4" × 1⅜"
Cord: 10' clear with plug-in driver Switch: touch dimmer on shade						

Generation 4

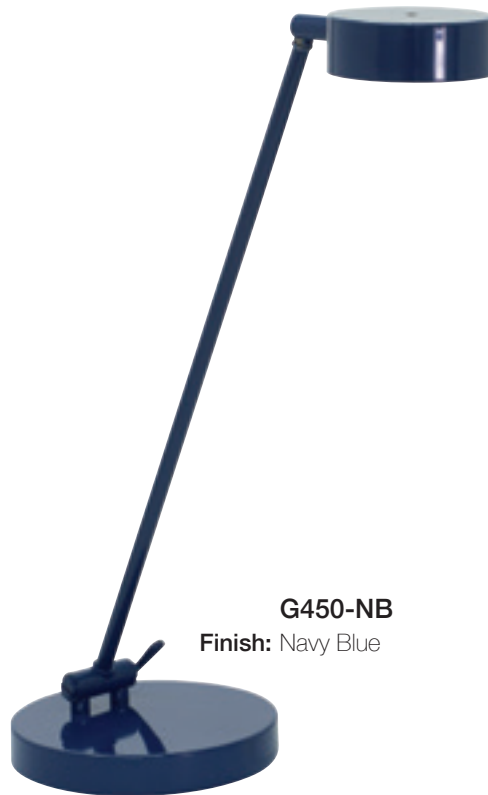

Fixture	Height	Extension	Base	Shade Material	LED	Shade Size
G450-PG	adjusts 11" to 16½"	22"	7" with USB port	metal	Integrated 3000K, 80 CRI, 6 Watts, 500 Lumens	4" × 1¾"
G450-NB	adjusts 11" to 16½"	22"	7" with USB port	metal	Integrated 3000K, 80 CRI, 6 Watts, 500 Lumens	4" × 1¾"
G450-WT	adjusts 11" to 16½"	22"	7" with USB port	metal	Integrated 3000K, 80 CRI, 6 Watts, 500 Lumens	4" × 1¾"
<p>Cord: 10' clear with plug-in driver Switch: touch dimmer on shade</p>						

Generation 4

Plug-in Only



G475-WT
Finish: White



G475-BLK
Finish: Black



G475-GT
Finish: Granite

Fixture	Height	Extension	Backplate	Shade Material	LED	Shade Size
G475-BLK	5"	21½"	7"	metal	Integrated 3000K, 80 CRI, 6 Watts, 500 Lumens	4" × 1⅜"
G475-GT	5"	21½"	7"	metal	Integrated 3000K, 80 CRI, 6 Watts, 500 Lumens	4" × 1⅜"
G475-WT	5"	21½"	7"	metal	Integrated 3000K, 80 CRI, 6 Watts, 500 Lumens	4" × 1⅜"
<p>Cord: 10' clear with plug-in driver and 30" cord cover Switch: touch dimmer on shade</p>						

Generation 4

Plug-in Only



G475-PG
Finish: Platinum Gray



G475-ABZ
Finish: Architectural Bronze

Fixture	Height	Extension	Backplate	Shade Material	LED	Shade Size
G475-PG	5"	21½"	7"	metal	Integrated 3000K, 80 CRI, 6 Watts, 500 Lumens	4" x 1½"
G475-ABZ	5"	21½"	7"	metal	Integrated 3000K, 80 CRI, 6 Watts, 500 Lumens	4" x 1½"
<p>Cord: 10' clear with plug-in driver and 30" cord cover Switch: touch dimmer on shade</p>						

Generation 5



G500-ABZ (*Architectural Bronze*)

The American Made Generation 5 is a powder coated task lamps. The Generation 5 uses our latest 800 lumen LED array and is dimmable and adjustable.

Generation 5

Plug-in Only



Fixture	Height	Extension	Base	Shade Material	LED	Shade Size
G500-ABZ	adjusts 42" to 51½"	17"	6" x 7¼"	metal	Integrated 2900K, 96 CRI, 6.8 Watts, 800 Lumens	2½" x 5"
G550-ABZ	17½"	11½"	6" x 7¼" with USB port	metal	Integrated 2900K, 96 CRI, 6.8 Watts, 800 Lumens	2½" x 5"
G575-ABZ	5"	22¼"	5" x 5"	metal	Integrated 2900K, 96 CRI, 6.8 Watts, 800 Lumens included	2½" x 5"
<p>Cord: 10' clear with plug-in driver – G575 includes 30" cord cover Switch: touch dimmer on shade</p>						

Geo Mini



GEO106 (White)

Our Geo Mini lamps are the perfect accent lamp for a hallway, bedroom or entry. Small in stature, powder coated in four finishes, and easily switched on the cord. Made in Vermont.



GEO206

Finish: White with
Weathered Brass Accents



GEO106

Finish: White with
Weathered Brass Accents



GEO306

Finish: White with
Weathered Brass Accents

Fixture	Height	Depth	Base	Shade Material	Bulb	Shade Size	Shade Number
GEO106	12"	6"	4½"	white linen hardback	40W B10	4" × 6" × 6"	40215W
GEO206	12"	6"	5"	white linen hardback	40W B10	4" × 6" × 6"	40215W
GEO306	12"	6"	4½"	white linen hardback	40W B10	4" × 6" × 6"	40215W

Cord: 10' clear
Switch: on/off in-line 6" from base

Geo Mini



GEO209
Finish: Navy Blue with
 Weathered Brass Accents



GEO109
Finish: Navy Blue with
 Weathered Brass Accents



GEO309
Finish: Navy Blue with
 Weathered Brass Accents

Fixture	Height	Depth	Base	Shade Material	Bulb	Shade Size	Shade Number
GEO109	12"	6"	4½"	white linen hardback	40W B10	4" x 6" x 6"	40215W
GEO209	12"	6"	5"	white linen hardback	40W B10	4" x 6" x 6"	40215W
GEO309	12"	6"	4½"	white linen hardback	40W B10	4" x 6" x 6"	40215W
Cord: 10' clear Switch: on/off in-line 6" from base							

Geo Mini



GEO210

Finish: Black Matte with Polished Nickel Accents



GEO110

Finish: Black Matte with Polished Nickel Accents



GEO310

Finish: Black Matte with Polished Nickel Accents

Fixture	Height	Depth	Base	Shade Material	Bulb	Shade Size	Shade Number
GEO110	12"	6"	4½"	white linen hardback	40W B10	4" × 6" × 6"	40215W
GEO210	12"	6"	5"	white linen hardback	40W B10	4" × 6" × 6"	40215W
GEO310	12"	6"	4½"	white linen hardback	40W B10	4" × 6" × 6"	40215W
Cord: 10' clear Switch: on/off in-line 6" from base							

Geo Mini



GEO211

Finish: Mahogany Bronze
with Weathered Brass Accents



GEO311

Finish: Mahogany Bronze
with Weathered Brass Accents



GEO411

Finish: Mahogany Bronze
with Weathered Brass Accents



GEO111

Finish: Mahogany Bronze
with Weathered Brass Accents

Fixture	Height	Depth	Base	Shade Material	Bulb	Shade Size	Shade Number
GEO111	12"	6"	4½"	white linen hardback	40W B10	4" x 6" x 6"	40215W
GEO211	12"	6"	5"	white linen hardback	40W B10	4" x 6" x 6"	40215W
GEO311	12"	6"	4½"	white linen hardback	40W B10	4" x 6" x 6"	40215W
GEO411	13"	6"	5"	white linen hardback	40W B10	4" x 6" x 6"	40215W
Cord: 10' clear Switch: on/off in-line 6" from base							



PH100-91-J (*Oil Rubbed Bronze*)

Our Home Office series is clean lined and functional. Two shade styles in the wall and floor versions allow for multiple look and light style options.

Home Office



PH100-51-F
Finish: Satin Brass



PH100-52-F
Finish: Satin Nickel



PH100-71-F
Finish: Antique Brass



PH100-91-F
Finish: Oil Rubbed Bronze

Fixture	Height	Extension	Base	Shade Material	Bulb	Shade Size	Cord
PH100-51-F	adjusts 34" to 48"	23"	10½"	metal	one 60T-10	10" x 2"	10' brown
PH100-52-F	adjusts 34" to 48"	23"	10½"	metal	one 60T-10	10" x 2"	10' clear
PH100-71-F	adjusts 34" to 48"	23"	10½"	metal	one 60T-10	10" x 2"	10' brown
PH100-91-F	adjusts 34" to 48"	23"	10½"	metal	one 60T-10	10" x 2"	10' brown
Switch: on/off on socket							

Home Office

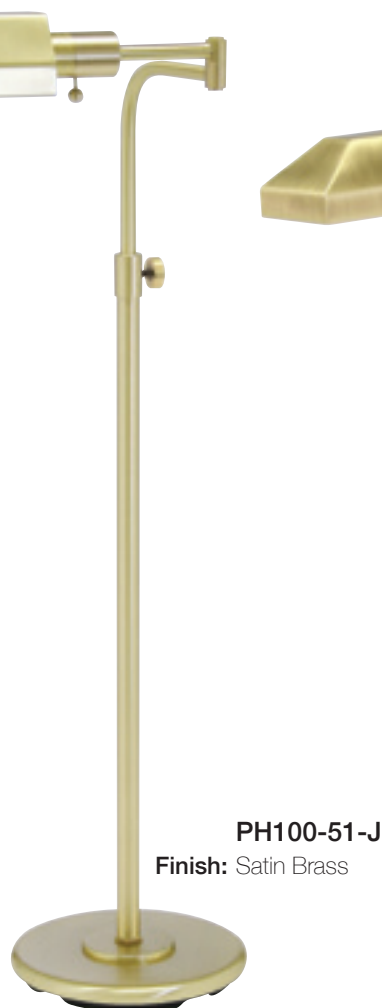

Fixture	Height	Extension	Base	Shade Material	Bulb	Shade Size	Cord
PH100-91-J	adjusts 34" to 48"	21"	10½"	metal	one 100W Type A	8⅞" × 3"	10' brown
PH100-52-J	adjusts 34" to 48"	21"	10½"	metal	one 100W Type A	8⅞" × 3"	10' clear
PH100-51-J	adjusts 34" to 48"	21"	10½"	metal	one 100W Type A	8⅞" × 3"	10' brown
PH100-71-J	adjusts 34" to 48"	21"	10½"	metal	one 100W Type A	8⅞" × 3"	10' brown
Switch: on/off on socket							

Home Office

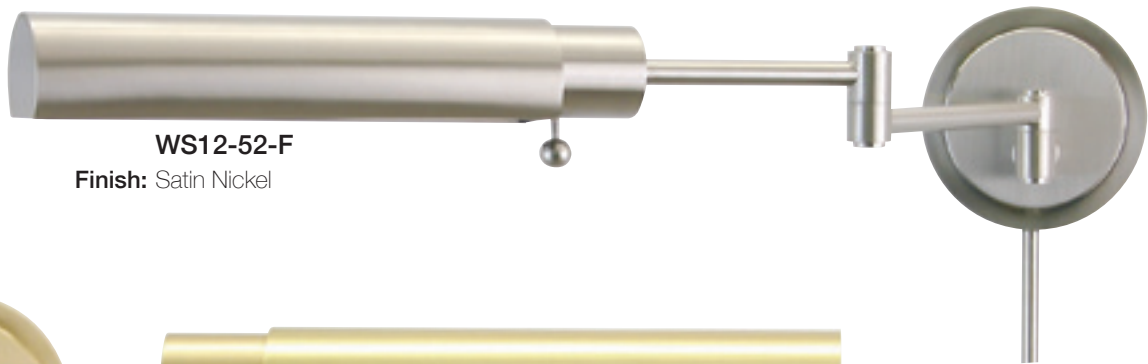

WS12-52-F
Finish: Satin Nickel



WS12-51-F
Finish: Satin Brass

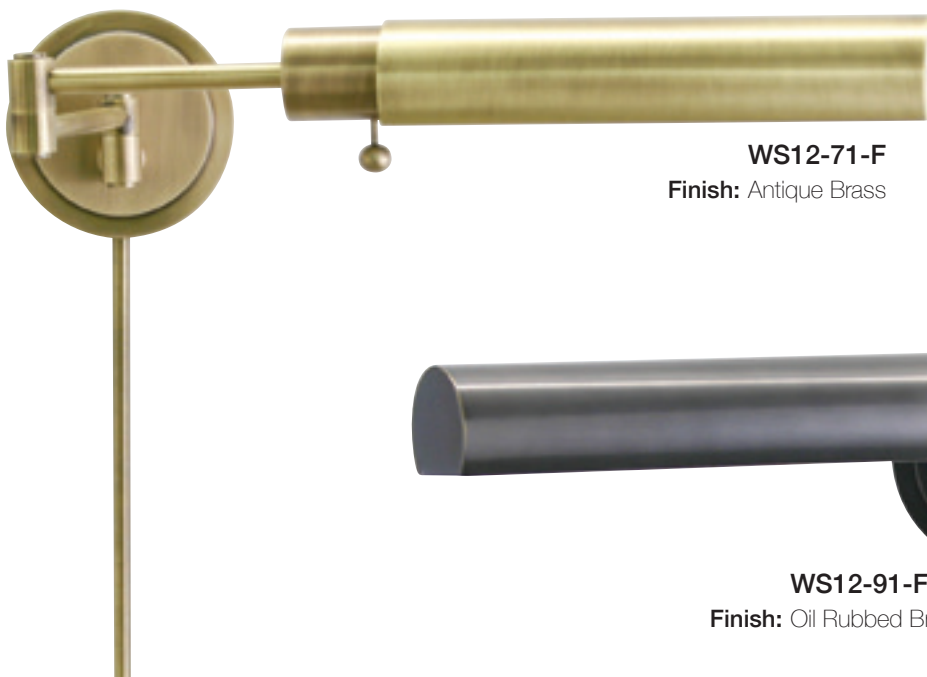

WS12-71-F
Finish: Antique Brass



WS12-91-F
Finish: Oil Rubbed Bronze

Fixture	Height	Extension	Backplate	Shade Material	Bulb	Shade Size
WS12-52-F	5"	26"	5"	metal	One 60T10	10" x 2"
WS12-51-F	5"	26"	5"	metal	One 60T10	10" x 2"
WS12-71-F	5"	26"	5"	metal	One 60T10	10" x 2"
WS12-91-F	5"	26"	5"	metal	One 60T10	10" x 2"
Cord: 10' clear with 30" cord cover Switch: on/off on socket						

Home Office

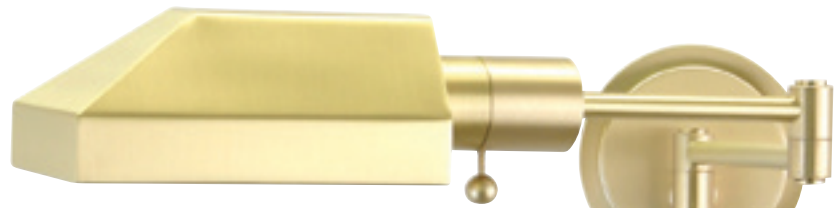

WS12-51-J
Finish: Satin Brass



WS12-52-J
Finish: Satin Nickel

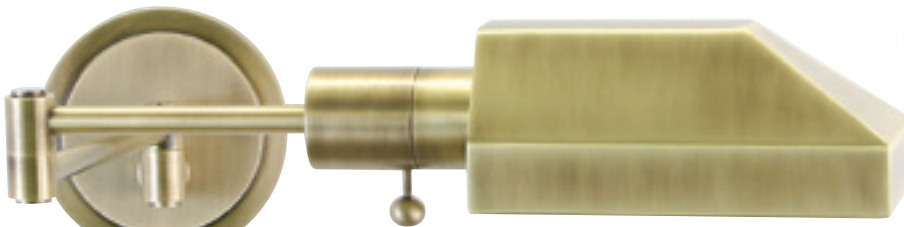

WS12-71-J
Finish: Antique Brass



WS12-91-J
Finish: Oil Rubbed Bronze

Fixture	Height	Extension	Backplate	Shade Material	Bulb	Shade Size
WS12-51-J	5"	24"	5"	metal	one 100W Type A	8¾" x 3"
WS12-52-J	5"	24"	5"	metal	one 100W Type A	8¾" x 3"
WS12-71-J	5"	24"	5"	metal	one 100W Type A	8¾" x 3"
WS12-91-J	5"	24"	5"	metal	one 100W Type A	8¾" x 3"

Cord: 10' clear with 30" cord cover
Switch: on/off on socket

Home Office



WS14-2-71
Finish: Antique Brass



WS14-2-52
Finish: Satin Nickel



WS14-2-91
Finish: Oil Rubbed Bronze

Fixture	Height	Extension	Backplate	Shade Material	Bulb	Shade Size	Shade Number
WS14-2-71	12½"	27"	18" × 4½" × ⅝"	off-white linen hardback	two 100W 3-way	6½" × 12" × 7" attaches with acrylic diffuser	40403
WS14-2-52	12½"	27"	18" × 4½" × ⅝"	white linen hardback	two 100W 3-way	6½" × 12" × 7" attaches with acrylic diffuser	40407
WS14-2-91	12½"	27"	18" × 4½" × ⅝"	off-white linen hardback	two 100W 3-way	6½" × 12" × 7" attaches with acrylic diffuser	40403
<p>Cord: 10' clear with 30" cord cover Switch: on/off on socket Diffuser Number: 80562</p>							

Home Office



WS14-52
Finish: Satin Nickel



WS14-51
Finish: Satin Brass



WS14-61
Finish: Polished Brass

Fixture	Height	Extension	Backplate	Shade Material	Bulb	Shade Size	Shade Number
WS14-51	12"	27"	5"	off-white linen hardback	one 100W 3-way	6½" × 12" × 7" attaches with acrylic diffuser	40403
WS14-52	12"	27"	5"	white linen hardback	one 100W 3-way	6½" × 12" × 7" attaches with acrylic diffuser	40407
WS14-61	12"	27"	5"	off-white linen hardback	one 100W 3-way	6½" × 12" × 7" attaches with acrylic diffuser	40403

Cord: 10' clear with 30" cord cover
Switch: on/off on socket
Diffuser Number: 80562

Home Office



WS14-9
Finish: White



WS14-71
Finish: Antique Brass



WS14-91
Finish: Oil Rubbed Bronze

Fixture	Height	Extension	Backplate	Shade Material	Bulb	Shade Size	Shade Number
WS14-71	12"	27"	5"	off-white linen hardback	one 100W 3-way	6½" × 12" × 7" attaches with acrylic diffuser	40403
WS14-9	12"	27"	5"	white linen hardback	one 100W 3-way	6½" × 12" × 7" attaches with acrylic diffuser	40407
WS14-91	12"	27"	5"	off-white linen hardback	one 100W 3-way	6½" × 12" × 7" attaches with acrylic diffuser	40403
<p>Cord: 10' clear with 30" cord cover Switch: on/off on socket Diffuser Number: 80562</p>							



HLEDZ600-GT (*Granite*)

Minimal in their design, with 500 lumens of light output, the Horizon Task series is suited to illuminate your work surface. Table and floor designs are fully adjustable, and powder coated for durability. Made in America.

Horizon



Fixture	Height	Extension	Base	Shade Material	LED	Shade Size
HLEDZ600-ABZ	adjusts 37½" to 49½"	20½"	10½" × 8½"	metal	Integrated 3000K, 85 CRI, 4.5 Watts, 500 Lumens	14"
HLEDZ600-GT	adjusts 37½" to 49½"	20½"	10½" × 8½"	metal	Integrated 3000K, 85 CRI, 4.5 Watts, 500 Lumens	14"
HLEDZ650-ABZ	adjusts 12" to 19"	29" maximum	7¼" × 6"	metal	Integrated 3000K, 85 CRI, 4.5 Watts, 500 Lumens	14"
HLEDZ650-GT	adjusts 12" to 19"	29" maximum	7¼" × 6"	metal	Integrated 3000K, 85 CRI, 4.5 Watts, 500 Lumens	14"
Cord: 10' brown Switch: on/off on shade						

Hyde Park



HP700-OB-WL (*Oil Rubbed Bronze*)

Full range dimming on table and wall make for excellent couch or bedside control on this Hyde Park series. Made at our factory in Hyde Park, Vermont.

Hyde Park



HP700-OB-WL

Finish: Oil Rubbed Bronze



HP700-OB-BP

Finish: Oil Rubbed Bronze



HP700-OB-MSOB

Finish: Oil Rubbed Bronze

Fixture	Height	Extension	Base	Shade Material	Bulb	Shade Size	Shade Number
HP700-OB-WL	57"	19½"	10"	off-white linen hardback	one 100W Type A	5" × 9" × 7"	40277
HP700-OB-BP	57"	19½"	10"	black parchment	one 100W Type A	5" × 9" × 7"	40275
HP700-OB-MSOB	57"	19½"	10"	metal	one 100W Type A	5" × 7½" × 6¼"	MSOB
Cord: 8' brown Switch: hi/lo on column							

Hyde Park



HP700-WB-MSWB
Finish: Weathered Brass

HP700-WB-WL
Finish: Weathered Brass

HP700-WB-BP
Finish: Weathered Brass

Fixture	Height	Extension	Base	Shade Material	Bulb	Shade Size	Shade Number
HP700-WB-MSWB	57"	19½"	10"	metal	one 100W Type A	5" × 7½" × 6¼"	MSWB
HP700-WB-WL	57"	19½"	10"	off-white linen hardback	one 100W Type A	5" × 9" × 7"	40277
HP700-WB-BP	57"	19½"	10"	black parchment	one 100W Type A	5" × 9" × 7"	40275
Cord: 8' brown Switch: hi/lo on column 38" from base							

Hyde Park

HP725-OB-BP

Finish: Oil Rubbed Bronze



HP725-OB-WL

Finish: Oil Rubbed Bronze

HP725-OB-MSOB

Finish: Oil Rubbed Bronze



Fixture	Height	Extension	Backplate	Shade Material	Bulb	Shade Size	Shade Number
HP725-OB-BP	12½"	20"	5"	black parchment	one 100W Type A	5" x 9" x 7"	40275
HP725-OB-WL	12½"	20"	5"	off-white linen hardback	one 100W Type A	5" x 9" x 7"	40277
HP725-OB-MSOB	12½"	20"	5"	metal	one 100W Type A	5" x 7½" x 6¼"	MSOB
Cord: 10' ivory with 30" cord cover Switch: full range dimmer on backplate							

Hyde Park



HP725-WB-MSWB
Finish: Weathered Bronze



HP725-WB-WL
Finish: Weathered Brass



HP725-WB-BP
Finish: Weathered Brass

Fixture	Height	Extension	Backplate	Shade Material	Bulb	Shade Size	Shade Number
HP725-WB-MSWB	12½"	20"	5"	metal	one 100W Type A	5" x 7½" x 6¼"	MSWB
HP725-WB-BP	12½"	20"	5"	black parchment	one 100W Type A	5" x 9" x 7"	40275
HP725-WB-WL	12½"	20"	5"	off-white linen hardback	one 100W Type A	5" x 9" x 7"	40277
Cord: 10' ivory with 30" cord cover Switch: full range dimmer on backplate							

Hyde Park



HP750-OB-MSOB

Finish: Oil Rubbed Bronze

HP750-OB-BP
Finish: Oil Rubbed Bronze



HP750-OB-WL

Finish: Oil Rubbed Bronze



Fixture	Height	Extension	Base	Shade Material	Bulb	Shade Size	Shade Number
HP750-OB-MSOB	26"	14"	7"	metal	one 100W Type A	5" x 7½" x 6¼"	MSOB
HP750-OB-WL	26"	14"	7"	off-white linen hardback	one 100W Type A	5" x 9" x 7"	40277
HP750-OB-BP	26"	14"	7"	black parchment	one 100W Type A	5" x 9" x 7"	40275
<p>Cord: 10' brown Switch: full range dimmer</p>							

Hyde Park



HP750-WB-BP
Finish: Weathered Brass



HP750-WB-MSWB
Finish: Weathered Brass



HP750-WB-WL
Finish: Weathered Brass

Fixture	Height	Extension	Base	Shade Material	Bulb	Shade Size	Shade Number
HP750-WB-BP	26"	14"	7"	black parchment	one 100W Type A	5" x 9" x 7"	40275
HP750-WB-WL	26"	14"	7"	off-white linen hardback	one 100W Type A	5" x 9" x 7"	40277
HP750-WB-MSWB	26"	14"	7"	metal	one 100W Type A	5" x 7½" x 6¼"	MSWB
Cord: 10' brown Switch: full range dimmer							

Jay



JLEDZ500-BLK (Black)

The American Made Jay Collection features metal on metal with a modern look. An integrated LED array with a full range dimmer and sleek metal shade directs the light. Powdercoat finishes create a durable contrast that stands the test of time.

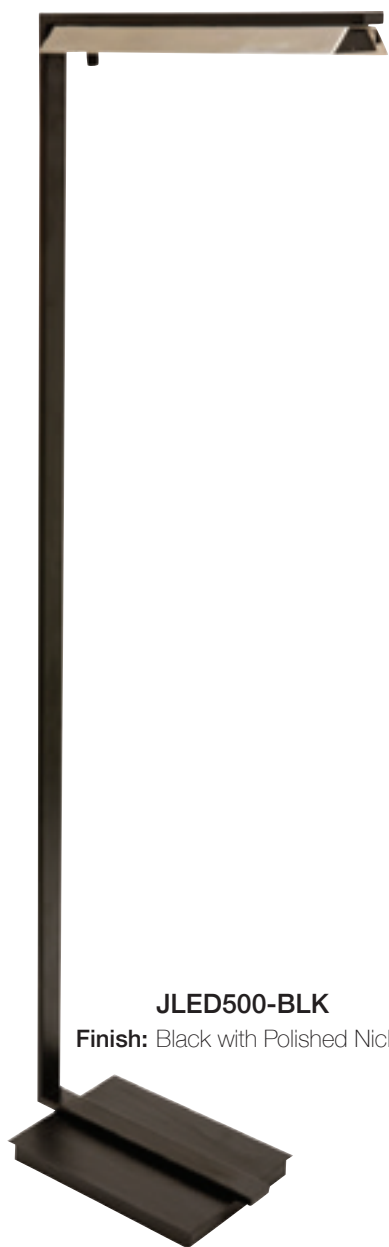

JLED500-BLK
Finish: Black with Polished Nickel

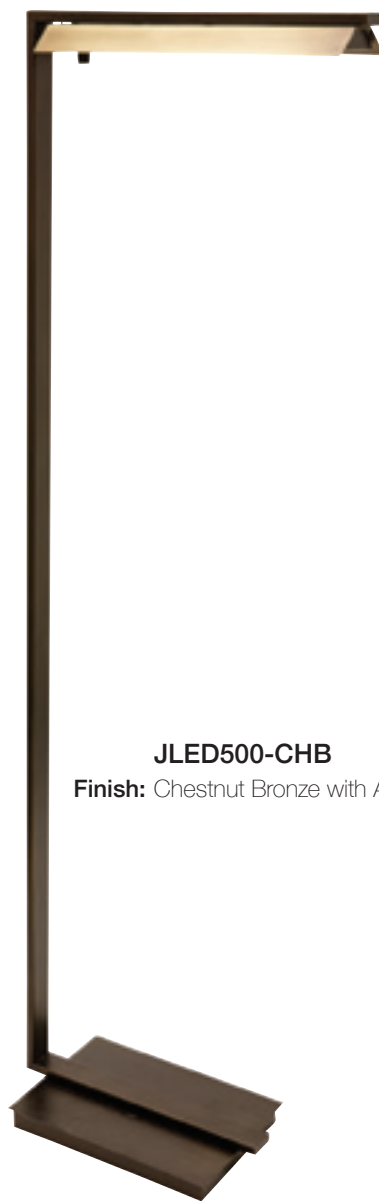

JLED500-CHB
Finish: Chestnut Bronze with Antique Brass

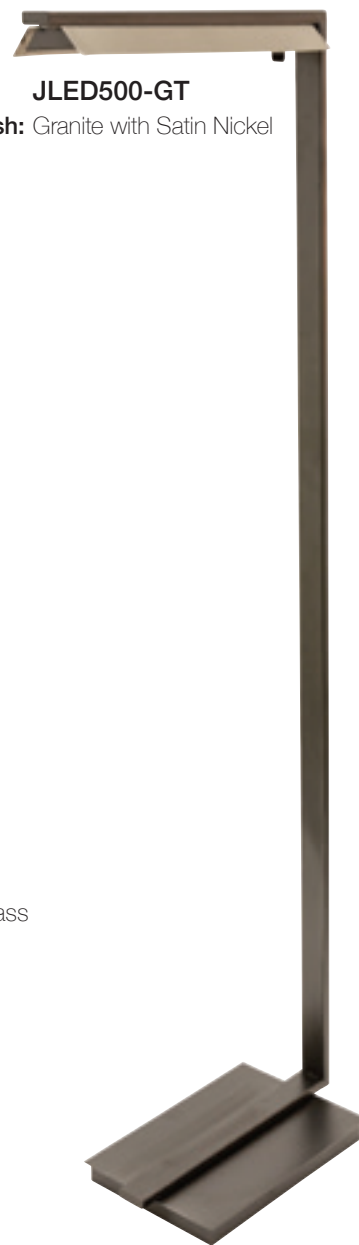

JLED500-GT
Finish: Granite with Satin Nickel

Fixture	Height	Extension	Base	Shade Material	LED	Shade Size	Cord
JLED500-BLK	52"	15½"	8" x 13"	metal	Integrated 3000K, 85 CRI, 4.5 Watts, 500 Lumens	3¾" x 14"	10' black
JLED500-CHB	52"	15½"	8" x 13"	metal	Integrated 3000K, 85 CRI, 4.5 Watts, 500 Lumens	3¾" x 14"	10' brown
JLED500-GT	52"	15½"	8" x 13"	metal	Integrated 3000K, 85 CRI, 4.5 Watts, 500 Lumens	3¾" x 14"	10' black

Switch: full range dimmer on shade



JLED550-BLK
Finish: Black with Polished Nickel



JLED550-GT
Finish: Granite with Satin Nickel



JLED550-CHB
Finish: Chestnut Bronze with Antique Brass

Fixture	Height	Extension	Base	Shade Material	LED	Shade Size	Cord
JLED550-BLK	19"	15½"	4½" × 12"	metal	Integrated 3000K, 85 CRI, 4.5 Watts, 500 Lumens	3¾" × 14"	10' black
JLED550-CHB	19"	15½"	4½" × 12"	metal	Integrated 3000K, 85 CRI, 4.5 Watts, 500 Lumens	3¾" × 14"	10' brown
JLED550-GT	19"	15½"	4½" × 12"	metal	Integrated 3000K, 85 CRI, 4.5 Watts, 500 Lumens	3¾" × 14"	10' black
Switch: full range dimmer on shade							



KL300-BLK (*Black*)

The knurled features on our Killington Collection add an industrial touch to our floor, table and wall lamps. A sturdy imported line with an off-white hardback shade. Each lamp has a special feature if it's a six-way socket, twin pull chain with a glass accent table, or a USB port on the base of the table lamps.

Killington



KL300-BB

Finish: Brushed Brass



KL300-BLK

Finish: Black



Fixture	Height	Depth	Base	Shade Material	Bulb	Shade Size	Cord	Shade Number
KL300-BB	64"	18"	10"	off-white hardback	one 150W 3-way three 75W single	16" x 18" x 11"	10' brown	40572
KL300-BLK	64"	18"	10"	off-white hardback	one 150W 3-way three 75W single	16" x 18" x 11"	10' clear	40572BLK
Switch: on column								



KL302-BB
Finish: Brushed Brass



KL302-BLK
Finish: Black



Fixture	Height	Depth	Base	Shade Material	Bulb	Shade Size	Cord	Shade Number
KL302-BB	62"	18"	10"	off-white hardback	two 100W type A	16" x 18" x 11"	10' brown	40572
KL302-BLK	62"	18"	10"	off-white hardback	two 100W type A	16" x 18" x 11"	10' clear	40572BLK
Switch: twin pull chain on socket								

Killington



KL350-BB
Finish: Brushed Brass



KL350-BLK
Finish: Black

Fixture	Height	Depth	Base	Shade Material	Bulb	Shade Size	Cord	Shade Number
KL350-BB	29"	15"	8" with USB port	off-white hardback	150W 3-way	13" x 15" x 10"	10' brown	40574
KL350-BLK	29"	15"	8" with USB port	off-white hardback	150W 3-way	13" x 15" x 10"	10' clear	40574BLK
Switch: 3-way on socket								

Direct Wire Only



KL325-BB
Finish: Brushed Brass



KL325-BLK
Finish: Black

Fixture	Height	Depth	Backplate	Shade Material	Bulb	Shade Size	Shade Number
KL325-BB	17"	10"	5"	off-white hardback	60W type A	6" x 8" x 7"	40573
KL325-BLK	17"	10"	5"	off-white hardback	60W type A	6" x 8" x 7"	40573BLK

Switch: full range dimmer on backplate



K130-BLK (Black)

Our American Made Kirby Collection has a vintage look but on the inside it's all modern. Features include an integrated LED array, easy access switching on the shade, and maximum adjustability. The desk lamps come with USB port in base.



Fixture	Height	Depth	Base	Shade Material	LED	Shade Size
K100-GR	adjusts 42" to 54"	20½"	11"	metal	Integrated 3000K, 90 CRI, 6.5 Watts, 600 Lumens	2¼" × 4¼" × 5½"
K100-WT	adjusts 42" to 54"	20½"	11"	metal	Integrated 3000K, 90 CRI, 6.5 Watts, 600 Lumens	2¼" × 4¼" × 5½"
K100-BLK	adjusts 42" to 54"	20½"	11"	metal	Integrated 3000K, 90 CRI, 6.5 Watts, 600 Lumens	2¼" × 4¼" × 5½"
Cord: 10' silver Switch: on/off on shade						

Kirby



K130-WT
Finish: White

K130-GR
Finish: Gray

K130-BL
Finish: Black

Fixture	Height	Extension	Base	Shade Material	LED	Shade Size
K130-WT	64"	5½"	11"	metal	Integrated 3000K, 90 CRI, 6.5 Watts, 600 Lumens	2¼" × 4¼" × 5½"
K130-GR	64"	5½"	11"	metal	Integrated 3000K, 90 CRI, 6.5 Watts, 600 Lumens	2¼" × 4¼" × 5½"
K130-BL	64"	5½"	11"	metal	Integrated 3000K, 90 CRI, 6.5 Watts, 600 Lumens	2¼" × 4¼" × 5½"
Cord: 10' silver Switch: on/off on shade						



K150-BLK
Finish: Black



K150-TL
Finish: Teal



K150-GR
Finish: Gray

Fixture	Height	Extension	Base	Shade Material	LED	Shade Size
K150-BLK	23½"	13"	7" with USB port	metal	Integrated 3000K, 90 CRI, 6.5 Watts, 600 Lumens	2¼" × 4¼" × 5½"
K150-GR	23½"	13"	7" with USB port	metal	Integrated 3000K, 90 CRI, 6.5 Watts, 600 Lumens	2¼" × 4¼" × 5½"
K150-TL	23½"	13"	7" with USB port	metal	Integrated 3000K, 90 CRI, 6.5 Watts, 600 Lumens	2¼" × 4¼" × 5½"
Cord: 10' silver Switch: on/off on shade						



Fixture	Height	Extension	Base	Shade Material	LED	Shade Size
K150-WT	23½"	13"	7" with USB port	metal	Integrated 3000K, 90 CRI, 6.5 Watts, 600 Lumens	2¼" × 4¼" × 5½"
K150-PK	23½"	13"	7" with USB port	metal	Integrated 3000K, 90 CRI, 6.5 Watts, 600 Lumens	2¼" × 4¼" × 5½"
Cord: 10' silver Switch: on/off on shade						



K175-GR
Finish: Gray



K175-BLK
Finish: Black



K175-WT
Finish: White

Fixture	Height	Extension	Backplate	Shade Material	LED	Shade Size
K175-GR	6¼"	9½"	5"	metal	Integrated 3000K, 90 CRI, 6.5 Watts, 600 Lumens	2¼" × 4¼" × 5½"
K175-WT	6¼"	9½"	5"	metal	Integrated 3000K, 90 CRI, 6.5 Watts, 600 Lumens	2¼" × 4¼" × 5½"
K175-BLK	6¼"	9½"	5"	metal	Integrated 3000K, 90 CRI, 6.5 Watts, 600 Lumens	2¼" × 4¼" × 5½"
<p>Cord: 10' silver with 30" cord cover Switch: on/off on shade</p>						

Lancaster



L800-OB (*Oil Rubbed Bronze*)

A clean and transitional look for a classic six-way lamp offered in either floor or table versions.

Lancaster



L800-SN
Finish: Satin Nickel



L800-AB
Finish: Antique Brass



L800-OB
Finish: Oil Rubbed Bronze



L800-BLK
Finish: Black

Fixture	Height	Depth	Base	Shade Material	Bulb	Shade Size	Cord	Shade Number
L800-SN	62¾"	17"	11"	white linen hardback drum	one 150W 3-way, three 75W Type A	15" × 17" × 10½"	10' clear	40433
L800-AB	62¾"	17"	11"	off-white linen hardback drum	one 150W 3-way, three 75W Type A	15" × 17" × 10½"	10' brown	40432
L800-OB	62¾"	17"	11"	off-white linen hardback drum	one 150W 3-way, three 75W Type A	15" × 17" × 10½"	10' brown	40432
L800-BLK	62¾"	17"	11"	white linen hardback	one 150W 3-way, three 75W Type A	15" × 17" × 10½"	10' brown	40433BLK
Switch: on column								

Lancaster



L850-SN
Finish: Satin Nickel



L850-OB
Finish: Oil Rubbed Bronze



L850-AB
Finish: Antique Brass



L850-BLK
Finish: Black

Fixture	Height	Depth	Base	Shade Material	Bulb	Shade Size	Cord	Shade Number
L850-SN	31¾"	16"	8"	white linen hardback drum	one 150W 3-way, three 75W Type A	14" x 16" x 10½"	10' clear	40431A
L850-AB	31¾"	16"	8"	off-white linen hardback drum	one 150W 3-way, three 75W Type A	14" x 16" x 10½"	10' brown	40431
L850-OB	31¾"	16"	8"	off-white linen hardback drum	one 150W 3-way, three 75W Type A	14" x 16" x 10½"	10' brown	40431
L850-BLK	31¾"	16"	8"	white linen hardback drum	one 150W 3-way, three 75W Type A	14" x 16" x 10½"	10'	40431BLK
Switch: on column								

Plug-in Only



LEW875-BLK
Finish: Black with Satin Nickel



LEW850-BLK
Finish: Black with Satin Nickel



LEW800-BLK
Finish: Black with Satin Nickel

Fixture	Height	Extension	Base	Shade Material	LED	Shade Size
LEW875-BLK	5"	19"	5" x 5"	metal	Integrated 2900K, 96 CRI, 6.8 Watts, 800 Lumens	2½" x 5½"
LEW850-BLK	17½"	19"	6" x 7¼"	metal	Integrated 2900K, 96 CRI, 6.8 Watts, 800 Lumens	2½" x 5½"
LEW800-BLK	52"	19"	8½" x 10½"	metal	Integrated 2900K, 96 CRI, 6.8 Watts, 800 Lumens	2½" x 5½"
<p>Cord: 10' clear with plug-in driver – LEW875 includes 30" cord cover Switch: on/off on shade</p>						

Logan



L300-AZSB
Finish: Azure and Satin Brass

Finishes



Azure (AZ)



Black (BLK)

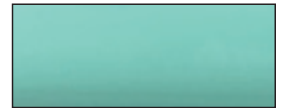

Mint (MT)

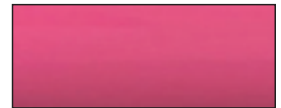

Orchid (OR)

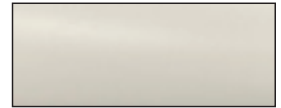

White (WT)

Fixture	Height	Width	Depth	Base	Shade Material	Bulb	Shade Size
L300-AZSB	48"-64"	10½"	18"-24"	10½"	metal	100 watt LED type A	(3½" × 5") (5½" × 6") × 12"
L300-BLKSN	48"-64"	10½"	18"-24"	10½"	metal	100 watt LED type A	(3½" × 5") (5½" × 6") × 12"
L300-MTSN	48"-64"	10½"	18"-24"	10½"	metal	100 watt LED type A	(3½" × 5") (5½" × 6") × 12"
L300-ORSB	48"-64"	10½"	18"-24"	10½"	metal	100 watt LED type A	(3½" × 5") (5½" × 6") × 12"
L300-WTSN	48"-64"	10½"	18"-24"	10½"	metal	100 watt LED type A	(3½" × 5") (5½" × 6") × 12"
Cord: 10' clear Switch: on/off on column							



L325-AZSB

Finish: Azure and Satin Brass



L325-ORSB

Finish: Orchid and Satin Brass



L325-MTSN

Finish: Mint and Satin Nickel



L325-BLKSN

Finish: Black and Satin Nickel



L325-WTSN

Finish: White and Satin Nickel

Fixture	Height	Width	Depth	Base	Shade Material	Bulb	Shade Size
L325-AZSB	10½"	9"-12"	5"	5"	metal	100 watt LED type A	(3½" × 5") (5½" × 6") × 10½"
L325-BLKSN	10½"	9"-12"	5"	5"	metal	100 watt LED type A	(3½" × 5") (5½" × 6") × 10½"
L325-MTSN	10½"	9"-12"	5"	5"	metal	100 watt LED type A	(3½" × 5") (5½" × 6") × 10½"
L325-ORSB	10½"	9"-12"	5"	5"	metal	100 watt LED type A	(3½" × 5") (5½" × 6") × 10½"
L325-WTSN	10½"	9"-12"	5"	5"	metal	100 watt LED type A	(3½" × 5") (5½" × 6") × 10½"

Switch: full range dimmer on backplate

Logan



L350-BLKSN

Finish: Black and Satin Nickel

Fixture	Height	Depth	Base	Shade Material	Bulb	Shade Size
L350-AZSB	23"-26"	14"-19"	8"	metal	100 watt LED type A	(3½" × 5") (5½" × 6") × 10½"
L350-BLKSN	23"-26"	14"-19"	8"	metal	100 watt LED type A	(3½" × 5") (5½" × 6") × 10½"
L350-MTSN	23"-26"	14"-19"	8"	metal	100 watt LED type A	(3½" × 5") (5½" × 6") × 10½"
L350-ORSB	23"-26"	14"-19"	8"	metal	100 watt LED type A	(3½" × 5") (5½" × 6") × 10½"
L350-WTSN	23"-26"	14"-19"	8"	metal	100 watt LED type A	(3½" × 5") (5½" × 6") × 10½"
<p>Cord: 10' clear Switch: full range dimmer on base</p>						

Finishes



Azure (AZ)



Black (BLK)

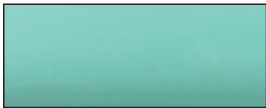

Mint (MT)

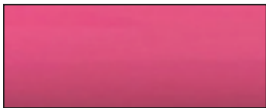

Orchid (OR)



White (WT)



L375-MTSN

Finish: Mint and Satin Nickel

Fixture	Height	Width	Depth	Backplate	Shade Material	Bulb	Shade Size
L375-AZSB	10½"	5½"	17"-27"	5"	metal	100 watt LED type A	(3½" x 5") (5½" x 6") x 10½"
L375-BLKSN	10½"	5½"	17"-27"	5"	metal	100 watt LED type A	(3½" x 5") (5½" x 6") x 10½"
L375-MTSN	10½"	5½"	17"-27"	5"	metal	100 watt LED type A	(3½" x 5") (5½" x 6") x 10½"
L375-ORSB	10½"	5½"	17"-27"	5"	metal	100 watt LED type A	(3½" x 5") (5½" x 6") x 10½"
L375-WTSN	10½"	5½"	17"-27"	5"	metal	100 watt LED type A	(3½" x 5") (5½" x 6") x 10½"

Cord: 8' ivory with 30" cord cover
Switch: full range on backplate

Morgan

NOTE: Cord exits from adjustment arm.

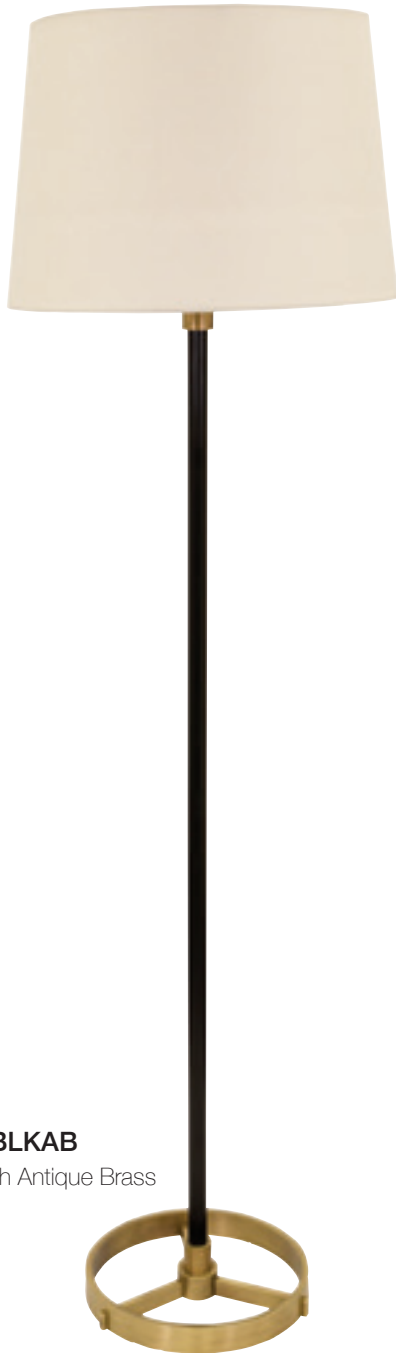

M600-BLKAB
Finish: Black with Antique Brass



M601-BLKAB
Finish: Black with Antique Brass

Fixture	Height	Extension	Base	Shade Material	Bulb	Shade Size	Shade Number
M600-BLKAB	62"	18"	11 $\frac{3}{4}$ "	off-white linen hardback	one 150W 3-way	15" x 18" x 12"	40586
M601-BLKAB	54" to 65"	19"	11 $\frac{3}{4}$ "	metal	one 75W Type A	5" x 9" x 7"	40583

Cord: 10' brown
Switch: on/off on socket



MO200-SN (*Satin Nickel*)

The Morris Collection is an American Made series that includes an integrated LED. The floor lamp has a clutchless adjustment so the height ranges from 39" to 51". The shade swivels for proper light placement for any job. Simple, precise and clean lines make this a desirable light.

Morris



MO200-OB
Finish: Oil Rubbed Bronze

MO200-AB
Finish: Antique Brass

MO200-SN
Finish: Satin Nickel

Fixture	Height	Extension	Base	Shade Material	LED	Shade Size	Cord
MO200-OB	adjusts 39" to 51"	10½"	10"	metal	Integrated 3000K, 80 CRI, 6.5 Watts, 600 Lumens	3¾" x 4"	10' brown
MO200-AB	adjusts 39" to 51"	10½"	10"	metal	Integrated 3000K, 80 CRI, 6.5 Watts, 600 Lumens	3¾" x 4"	10' brown
MO200-SN	adjusts 39" to 51"	10½"	10"	metal	Integrated 3000K, 80 CRI, 6.5 Watts, 600 Lumens	3¾" x 4"	10' clear
Switch: on/off on shade							



MO250-OB
Finish: Oil Rubbed Bronze

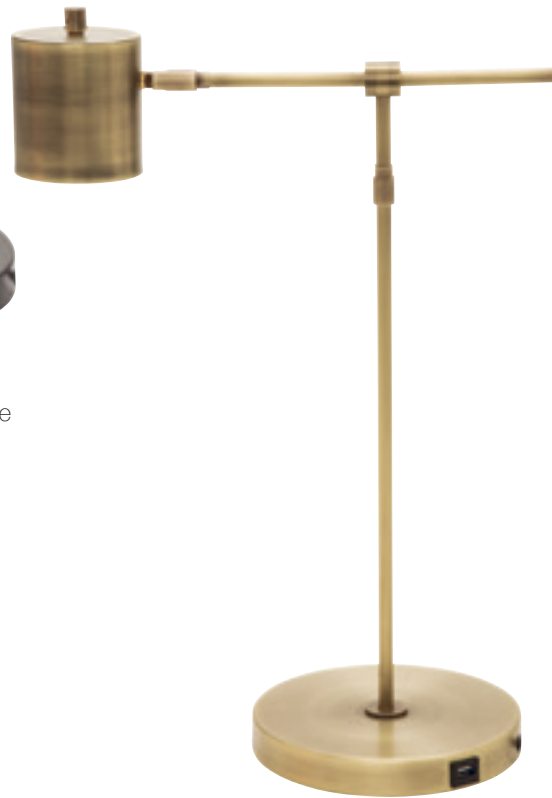

MO250-AB
Finish: Antique Brass



MO250-SN
Finish: Satin Nickel

Fixture	Height	Extension	Base	Shade Material	LED	Shade Size	Cord
MO250-OB	22"	10½"	8" with USB port	metal	Integrated 3000K, 80 CRI, 6.5 Watts, 600 Lumens	3¾" x 4"	10' brown
MO250-AB	22"	10½"	8" with USB port	metal	Integrated 3000K, 80 CRI, 6.5 Watts, 600 Lumens	3¾" x 4"	10' brown
MO250-SN	22"	10½"	8" with USB port	metal	Integrated 3000K, 80 CRI, 6.5 Watts, 600 Lumens	3¾" x 4"	10' clear
Switch: on/off on shade							

Morris

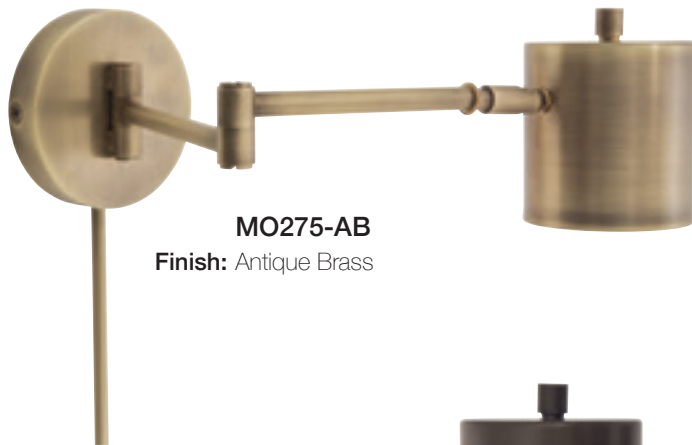

MO275-AB
Finish: Antique Brass



MO275-OB
Finish: Oil Rubbed Bronze



MO275-SN
Finish: Satin Nickel

Fixture	Height	Extension	Backplate	Shade Material	LED	Shade Size
MO275-AB	5"	21½"	5"	metal	Integrated 3000K, 80 CRI, 6.5 Watts, 600 Lumens	3¾" × 4"
MO275-OB	5"	21½"	5"	metal	Integrated 3000K, 80 CRI, 6.5 Watts, 600 Lumens	3¾" × 4"
MO275-SN	5"	21½"	5"	metal	Integrated 3000K, 80 CRI, 6.5 Watts, 600 Lumens	3¾" × 4"
Cord: 8' ivory with 30" cord cover Switch: on/off on shade						



Fixture	Height	Depth	Base	Shade Material	Bulb	Shade Size	Cord
NEW200-AB	42" to 54"	19"	7" x 7"	metal	one LED5W candelabra (included), 3000K, 90+ CRI, 5 Watts, 545 Lumens	2" x 3" x 7"	10' brown
NEW200-BLK	42" to 54"	19"	7" x 7"	metal	one LED5W candelabra (included), 3000K, 90+ CRI, 5 Watts, 545 Lumens	2" x 3" x 7"	10' black
NEW200-SN	42" to 54"	19"	7" x 7"	metal	one LED5W candelabra (included), 3000K, 90+ CRI, 5 Watts, 545 Lumens	2" x 3" x 7"	10' clear

Switch: full range dimmer on shade

Newbury



Fixture	Height	Depth	Base	Shade Material	Bulb	Shade Size	Cord
NEW250-AB	21"	20¼"	7" x 7" with USB port	metal	one LED5W candelabra (included), 3000K, 90+ CRI, 5 Watts, 545 Lumens	2" x 3" x 7"	10' brown
NEW250-BLK	21"	20¼"	7" x 7" with USB port	metal	one LED5W candelabra (included), 3000K, 90+ CRI, 5 Watts, 545 Lumens	2" x 3" x 7"	10' black
NEW250-SN	21"	20¼"	7" x 7" with USB port	metal	one LED5W candelabra (included), 3000K, 90+ CRI, 5 Watts, 545 Lumens	2" x 3" x 7"	10' clear
Switch: full range dimmer on shade							

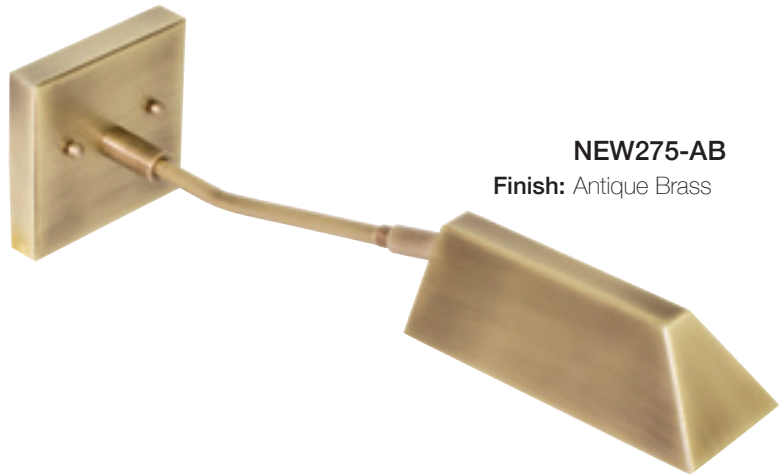

NEW275-AB
Finish: Antique Brass



NEW275-BLK
Finish: Black



NEW275-SN
Finish: Satin Nickel

Fixture	Height	Extension	Backplate	Shade Material	Bulb	Shade Size	Cord
NEW275-AB	5"	16 $\frac{5}{8}$ "	5" x 5" with USB port	metal	one LED5W candelabra (included), 3000K, 90+ CRI, 5 Watts, 545 Lumens	2" x 3" x 7"	10' brown with 30" cord cover
NEW275-BLK	5"	16 $\frac{5}{8}$ "	5" x 5" with USB port	metal	one LED5W candelabra (included), 3000K, 90+ CRI, 5 Watts, 545 Lumens	2" x 3" x 7"	10' black with 30" cord cover
NEW275-SN	5"	16 $\frac{5}{8}$ "	5" x 5" with USB port	metal	one LED5W candelabra (included), 3000K, 90+ CRI, 5 Watts, 545 Lumens	2" x 3" x 7"	10' clear with 30" cord cover
Switch: full range dimmer on shade							

Newport



N604-AB (*Antique Brass*)

Our most popular series, Newport offers great value for a classic style and functional light. Six-way floor and table lamps provide maximum light output.



N600-AB-O

Finish: Antique Brass



N600-OB-O

Finish: Oil Rubbed Bronze



N600-AB

Finish: Antique Brass



N600-OB

Finish: Oil Rubbed Bronze

Fixture	Height	Depth	Base	Shade Material	Bulb	Shade Size	Shade Number
N600-AB-O	69"	15¾"	12"	opal glass	one 150W Type A	15¾" × 6"	44550
N600-OB-O	69"	15¾"	12"	opal glass	one 150W Type A	15¾" × 6"	44550
N600-AB	74¾"	12"	12"	amber glass	one 150W Type A	9" × 11¾"	44549
N600-OB	74¾"	12"	12"	amber glass	one 150W Type A	9½" × 11¾"	44549
Cord: 10' brown Switch: full range floor dimmer							

Newport



N601-OB

Finish: Oil Rubbed Bronze



N601-PTR

Finish: Pewter



N601-AB

Finish: Antique Brass

Fixture	Height	Depth	Base	Shade Material	Bulb	Shade Size	Cord	Shade Number
N601-OB	57½"	19"	12"	off-white softback	two 100W Type A	12" × 19" × 12"	10' brown	40451
N601-PTR	57½"	19"	12"	white softback	two 100W Type A	12" × 19" × 12"	10' clear	40453
N601-AB	57½"	19"	12"	off-white softback	two 100W Type A	12" × 19" × 12"	10' brown	40451
Switch: twin pull chain								



N602-OB
Finish: Oil Rubbed Bronze



N602-AB
Finish: Antique Brass

Fixture	Height	Depth	Base	Shade Material	Bulb	Shade Size	Cord	Shade Number
N602-OB	55 $\frac{3}{4}$ "	19"	12"	off-white softback	one 150W 3-way	12" x 19" x 12"	10' brown	40451
N602-AB	55 $\frac{3}{4}$ "	19"	12"	off-white softback	one 150W 3-way	12" x 19" x 12"	10' clear	40451

Switch: on/off on socket
Table: 17" diameter and 24" height

Newport



N603-PTR

Finish: Pewter



N603-AB

Finish: Antique Brass



N603-OB

Finish: Oil Rubbed Bronze

Fixture	Height	Depth	Base	Shade Material	Bulb	Shade Size	Cord	Shade Number
N603-PTR	66½"	19"	12"	white softback	Standard Six-way, One 150W 3-way, Three 75W Single	12" x 19" x 12"	10' clear	40453
N603-AB	66½"	19"	12"	off-white softback	Standard Six-way, One 150W 3-way, Three 75W Single	12" x 19" x 12"	10' brown	40451
N603-OB	66½"	19"	12"	off-white softback	Standard Six-way, One 150W 3-way, Three 75W Single	12" x 19" x 12"	10' brown	40451
Switch: top of column								



N604-AB
Finish: Antique Brass



N604-OB
Finish: Oil Rubbed Bronze



N606-OB
Finish: Oil Rubbed Bronze



N606-AB
Finish: Antique Brass

Fixture	Height	Depth/ Extension	Base	Shade Material	Bulb	Shade Size	Switch	Shade Number
N604-AB	61"	23"	12"	off-white softback	one 150W 3-way	10" x 18" x 10½"	on socket	40455
N604-OB	61"	23"	12"	off-white softback	one 150W 3-way	10" x 18" x 10½"	on socket	40455
N606-OB	63"	19"	12"	off-white softback	Standard Six-way, One 150W 3-way, Three 75W Single	13" x 19" x 11½"	top of column	40465
N606-AB	63"	19"	12"	off-white softback	Standard Six-way, One 150W 3-way, Three 75W Single	13" x 19" x 11½"	top of column	40451

Cord: 10' brown

Newport



N652-OB

Finish: Oil Rubbed Bronze



N650-OB

Finish: Oil Rubbed Bronze



N650-AB

Finish: Antique Brass

Fixture	Height	Depth	Base	Shade Material	Bulb	Shade Size	Switch	Shade Number
N652-OB	30 3/4"	15 3/4"	6"	off-white softback	One 100W 3-way	7" x 15 3/4" x 11"	on socket	40459
N650-AB	30 1/4"	19"	9"	off-white softback	Standard Six-way, One 150W 3-way, Three 75W Single	12" x 19" x 12"	on column	40451
N650-OB	30 1/4"	19"	9"	off-white softback	Standard Six-way, One 150W 3-way, Three 75W Single	12" x 19" x 12"	on column	40451
Cord: 10' brown								



N651-PTR
Finish: Pewter



N651-OB
Finish: Oil Rubbed Bronze



N651-AB
Finish: Antique Brass

Fixture	Height	Depth	Base	Shade Material	Bulb	Shade Size	Cord	Shade Number
N651-PTR	30¼"	18"	7¾"	white softback	two 60W Type A	10" × 18" × 10¼"	10' clear	40457
N651-OB	30¼"	18"	7¾"	off-white softback	two 60W Type A	10" × 18" × 10¼"	10' brown	40455
N651-AB	30¼"	18"	7¾"	off-white softback	two 60W Type A	10" × 18" × 10¼"	10' brown	40455
Switch: twin pull chain								



NOR350-CHBAB (*Chestnut Bronze & Antique Brass*)

Let's talk about adjustment with the Norton Series. This light can easily move to any height and the shade swivels for just the right angle. The retro cord gives this light an artistic style for a great conversation piece. The wall swing can be mounted vertical or horizontal. Made in Vermont gives you the capability for custom work.

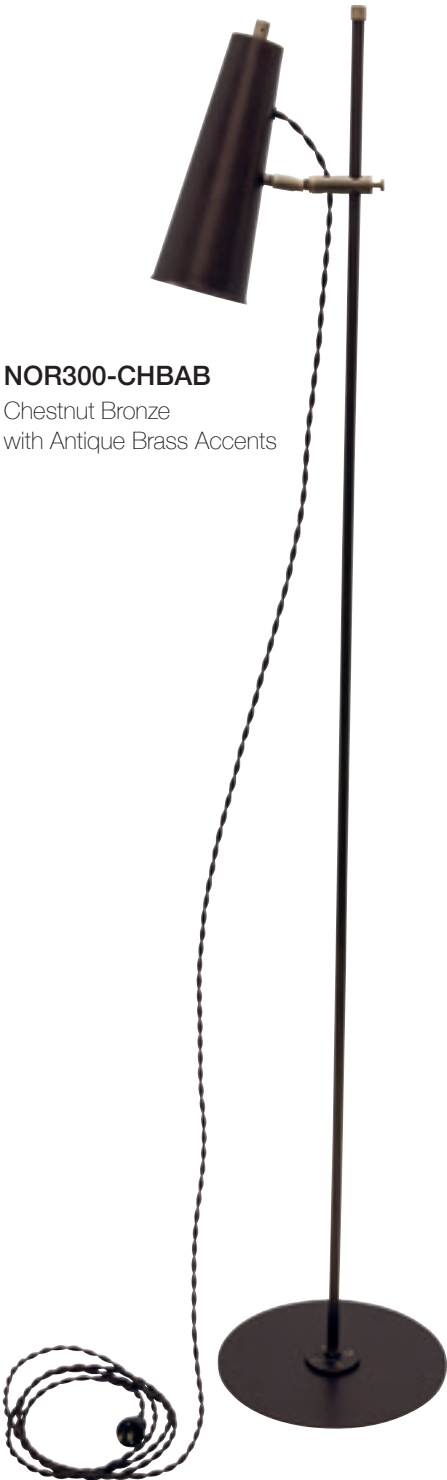

NOR300-CHBAB
Finish: Chestnut Bronze
 with Antique Brass Accents



NOR300-GTSN
Finish: Granite with
 Satin Nickel Accents

Fixture	Height	Extension	Base	Shade Material	LED	Shade Size
NOR300-CHBAB	adjusts to 59"	8½"	11"	metal	Integrated 3000K, 80 CRI, 6.2 Watts, 600 Lumens	2" x 4" x 10"
NOR300-GTSN	adjusts to 59"	8½"	11"	metal	Integrated 3000K, 80 CRI, 6.2 Watts, 600 Lumens	2" x 4" x 10"
Cord: 10' twisted black & brown cloth Switch: on/off on shade						

Norton



NOR350-GTSN

Finish: Granite with Satin Nickel Accents

NOR350-CHBAB

Finish: Chestnut Bronze with Antique Brass Accents

Fixture	Height	Extension	Base	Shade Material	LED	Shade Size
NOR350-GTSN	adjusts to 24"	8½"	8"	metal	Integrated 3000K, 80 CRI, 6.2 Watts, 600 Lumens	2" × 4" × 10"
NOR350-CHBAB	adjusts to 24"	8½"	8"	metal	Integrated 3000K, 80 CRI, 6.2 Watts, 600 Lumens	2" × 4" × 10"
Cord: 10' twisted black & brown cloth Switch: on/off on shade						

Available in Plug In Only



NOR375-CHBAB
Finish: Chestnut Bronze
 with Antique Brass Accents



NOR375-GTSN
Finish: Granite with Satin Nickel Accents

Fixture	Height	Extension	Shade Material	LED	Shade Size
NOR375-CHBAB	adjusts to 23"	13"	metal	Integrated 3000K, 80 CRI, 6.2 Watts, 600 Lumens	2" x 4" x 10"
NOR375-GTSN	adjusts to 23"	13"	metal	Integrated 3000K, 80 CRI, 6.2 Watts, 600 Lumens	2" x 4" x 10"
Cord: 10' twisted black & brown cloth Switch: on/off on shade					
custom length available – add multiple shades					

Orwell



OR700-BLKSN (*Black and Satin Nickel*)

The GU24-LED is included with the American Made Orwell Collection. The black and white houndstooth cloth cord creates a retro style on the floor and table lamps. The adjustment knob enables the light to move freely up and down the column. Lots of function wrapped in to these lamps.



OR700-WTWB
Finish: White with
 Weathered Brass Accents

OR700-BLKSN
Finish: Black with
 Satin Nickel Accents

Fixture	Height	Extension	Base	Shade Material	Bulb	Shade Size
OR700-WTWB	adjusts to 59"	24"	11"	metal	GU24-LED 2700K, 80 CRI, 11 Watts, 1100 Lumens (bulb included)	6" x 4¾"
OR700-BLKSN	adjusts to 59"	24"	11"	metal	GU24-LED 2700K, 80 CRI, 11 Watts, 1100 Lumens (bulb included)	6" x 4¾"
Cord: 10' black & white houndstooth cloth Switch: full range dimmer on shade						

Orwell

OR750-WTWB

Finish: White with
Weathered Brass Accents



OR750-BLKSN

Finish: Black with
Satin Nickel Accents



OR775-WTWB

Finish: White with
Weathered Brass Accents



OR775-BLKSN

Finish: Black with Satin Nickel Accents

Fixture	Height	Extension	Base/ Backplate	Shade Material	Bulb	Shade Size	Cord
OR750-WTWB	adjusts to 28"	19"	8"	metal	GU24-LED 2700K, 80 CRI, 11 Watts, 1100 Lumens (bulb included)	6" x 4¾"	10' black & white houndstooth cloth
OR750-BLKSN	adjusts to 28"	19"	8"	metal	GU24-LED 2700K, 80 CRI, 11 Watts, 1100 Lumens (bulb included)	6" x 4¾"	10' black & white houndstooth cloth
OR775-BLKSN	7½"	9"	5"	metal	GU24-LED 2700K, 80 CRI, 11 Watts, 1100 Lumens (bulb included)	6" x 4¾"	8' ivory with 30" cord cover
OR775-WTWB	7½"	9"	5"	metal	GU24-LED 2700K, 80 CRI, 11 Watts, 1100 Lumens (bulb included)	6" x 4¾"	8' ivory with 30" cord cover
Switch: full range dimmer on shade							



OT600-OB-MS (*Oil Rubbed Bronze*)

Reminiscent of the industrial work lights of a bygone era, the Otis series is an adjustable task lamp with mix and match metal and cased glass shades.

Otis

Glass Shade Options



Amber (AM)
#44551A



Green (GR)
#44551G



White (WT)
#44551W



OT600-AB-MS
Finish: Antique Brass



OT600-SN-MS
Finish: Satin Nickel

Fixture	Height	Extension	Base	Shade Material	Bulb	Shade Size	Cord	Shade Number
OT600-AB-MS	adjusts 49" to 67"	23"	10"	metal or glass	60W Type A	2¼" x 10" x 4¾"	10' brown	13449OB
OT600-SN-MS	adjusts 49" to 67"	23"	10"	metal or glass	60W Type A	2¼" x 10" x 4¾"	10' clear	13449SN
Switch: on/off on socket								

Glass Shade Options



Amber (AM)
#44551A



Green (GR)
#44551G



White (WT)
#44551W



OT650-AB-MS

Finish: Antique Brass



OT650-OB-MS

Finish: Oil Rubbed Bronze

Fixture	Height	Extension	Base	Shade Material	Bulb	Shade Size	Shade Number
OT650-AB-MS	26"	23"-34"	8½"	metal or glass	60W Type A	2¼" × 10" × 4¾"	13449AB
OT650-OB-MS	26"	23"-34"	8½"	metal or glass	60W Type A	2¼" × 10" × 4¾"	13449OB
Cord: 10' brown Switch: on/off on socket							

Otis

Glass Shade Options



Amber (AM)
#44551A



Green (GR)
#44551G



White (WT)
#44551W



OT675-OB-MS
Finish: Oil Rubbed Bronze



OT675-AB-MS
Finish: Antique Brass



OT675-SN-MS
Finish: Satin Nickel

Fixture	Height	Extension	Backplate	Shade Material	Bulb	Shade Size	Shade Number
OT675-OB-MS	10"	16½"	5"	metal or glass	60W Type A	2¼" × 10" × 4¾"	13449OB
OT675-AB-MS	10"	16½"	5"	metal or glass	60W Type A	2¼" × 10" × 4¾"	13449AB
OT675-SN-MS	10"	16½"	5"	metal or glass	60W Type A	2¼" × 10" × 4¾"	13449SN

Cord: 9' cord with 30" cord cover
Switch: on/off on socket

Otis Wall Swing Arm Lamps



OT625-AB

Finish: Antique Brass



OT625-OB

Finish: Oil Rubbed Bronze



OT625-SN

Finish: Satin Nickel

Fixture	Height	Extension	Backplate	Shade Material	Bulb	Shade Size	Shade Number
OT625-AB	adjustable	23"	5"	metal	one 60W Type A (not included)	2¼" × 10" × 4¾"	13449AB
OT625-SN	adjustable	23"	5"	metal	one 60W Type A (not included)	2¼" × 10" × 4¾"	13449SN
OT625-OB	adjustable	23"	5"	metal	one 60W Type A (not included)	2¼" × 10" × 4¾"	13449OB
Cord: 9' cord with 30" cord cover Switch: on/off on socket							

Pinnacle



PIN400-AB (*Antique Brass*)

Pinnacle is our halogen task series, offering full range dimming and height adjustment. Made in America and includes a GU10-50W halogen bulb.



Fixture	Height	Extension	Base	Shade Material	Bulb	Shade Size	Cord
PIN400-AB	adjusts from 35½" to 50"	21½"	10"	metal	one 50W GU10 Halogen (included)	6½" x 2¼"	10' clear
PIN400-OB	adjusts from 35½" to 50"	21½"	10"	metal	one 50W GU10 Halogen (included)	6½" x 2¼"	10' brown
PIN400-SN	adjusts from 35½" to 50"	21½"	10"	metal	one 50W GU10 Halogen (included)	6½" x 2¼"	10' clear

Switch: full range dimmer on shade

Pinnacle



PIN450-AB

Finish: Antique Brass

PIN450-OB

Finish: Oil Rubbed Bronze

PIN450-SN

Finish: Satin Nickel

Fixture	Height	Extension	Base	Shade Material	Bulb	Shade Size	Cord
PIN450-AB	16"	19½"	7"	metal	one 50W GU10 Halogen (included)	6½" × 2¼"	10' brown
PIN450-OB	16"	19½"	7"	metal	one 50W GU10 Halogen (included)	6½" × 2¼"	10' brown
PIN450-SN	16"	19½"	7"	metal	one 50W GU10 Halogen (included)	6½" × 2¼"	10' clear
Switch: full range dimmer on shade							

PIN475-AB

Finish: Antique Brass



PIN475-OB

Finish: Oil Rubbed Bronze



PIN475-SN

Finish: Satin Nickel



Fixture	Height	Extension	Backplate	Shade Material	Bulb	Shade Size
PIN475-AB	5½"	23¾"	5" x 5"	metal	one 50W GU10 Halogen (included)	6½" x 2¼"
PIN475-OB	5½"	23¾"	5" x 5"	metal	one 50W GU10 Halogen (included)	6½" x 2¼"
PIN475-SN	5½"	23¾"	5" x 5"	metal	one 50W GU10 Halogen (included)	6½" x 2¼"

Cord: 10' ivory with 30" cord cover
Switch: full range dimmer on shade

Randolph



RA300-OB (*Oil Rubbed Bronze*)

The Randolph Collection is a classic traditional series of floor and table lamps that we import. It provides a statue of quality along with a USB port on the glass table floor lamp option. Several styles make this a family of lamps that can enhance any room.



RA300-AB
Finish: Antique Brass



RA300-OB
Finish: Oil Rubbed Bronze

Fixture	Height	Depth	Base	Bulb	Shade Material	Shade Size	Shade Number
RA300-AB	63½"	18"	11"	two 100W Type A	off-white linen hardback	12" × 18" × 12"	40569
RA300-OB	63½"	18"	11"	two 100W Type A	off-white linen hardback	12" × 18" × 12"	40569
Cord: 10' brown Switch: twin pull chain							

Randolph



RA301-AB
Finish: Antique Brass



RA301-OB
Finish: Oil Rubbed Bronze

Fixture	Height	Extension	Base	Shade Material	Bulb	Shade Size	Shade Number
RA301-AB	58"	21"	11"	off-white linen hardback	one 150W 3-way	11" x 16" x 11"	40497
RA301-OB	58"	21"	11"	off-white linen hardback	one 150W 3-way	11" x 16" x 11"	40497
Cord: 10' brown Switch: on socket							



RA302-AB
Finish: Antique Brass



RA302-OB
Finish: Oil Rubbed Bronze

Fixture	Height	Depth	Base	Shade Material	Bulb	Shade Size	Shade Number
RA302-AB	57"	18"	11"	off-white linen hardback	one 150W 3-way	12" x 18" x 12"	40469
RA302-OB	57"	18"	11"	off-white linen hardback	one 150W 3-way	12" x 18" x 12"	40469
<p>Cord: 10' brown Switch: on socket Table: 12" with USB port, 24" from base</p>							

Randolph



RA350-AB
Finish: Antique Brass



RA350-OB
Finish: Oil Rubbed Bronze

Fixture	Height	Depth	Base	Shade Material	Bulb	Shade Size	Shade Number
RA350-AB	29"	16"	8"	off-white linen hardback	one 100W 3-way	11" x 16" x 11"	40497
RA350-OB	29"	16"	8"	off-white linen hardback	one 100W 3-way	11" x 16" x 11"	40497
Cord: 10' brown Switch: on socket							



R450-AB (*Antique Brass*)

The Richmond series combines a hardwood upright, hefty metal attachments and a simple burlap drum shade giving this lamp an industrial look and feel.

Richmond



R450-OB

Finish: Oil Rubbed Bronze with Walnut Finished Hardwood



R450-AB

Finish: Antique Brass with Walnut Finished Hardwood



R401-AB

Finish: Antique Brass with Walnut Finished Hardwood

Fixture	Height	Depth/Extension	Base	Shade Material	Bulb	Shade Size	Shade Number
R450-OB	adjusts 27½" to 31"	15"	8"	white burlap hardback	150W 3-way	11" x 15" x 10"	40556
R450-AB	adjusts 27½" to 31"	15"	8"	white burlap hardback	150W 3-way	11" x 15" x 10"	40556
R401-AB	adjusts 51½" to 59"	19½"	11"	white burlap hardback	150W 3-way	11" x 15" x 10"	40556
Cord: 10' brown Switch: on socket							



RN300-AB/SB (*Antique Brass and Satin Brass*)

Let the River North easel light bring a gallery to your home. This floor lamp allows you to easily change out your favorite artwork. The LED array provides a safe light for your image. The clamps quickly adjust up and down the column to hold any size art. Enjoy this American Made product.

River North



RN300-BLK/PB
Finish: Black/Polished Brass



RN300-AB/SB
Finish: Antique Brass/Satin Brass

Fixture	Height	Depth	Base	Shade Material	LED	Shade Size
RN300-BLK/PB	69"	10"-18"	10"	metal	one 2700K 90+CRI 4.5 watt 360 lumen LED	14" × 1"
RN300-AB/SB	69"	10"-18"	10"	metal	one 2700K 90+CRI 4.5 watt 360 lumen LED	14" × 1"

Cord: 12' black
Switch: floor dimmer
Clamp: adjusts from 0-2½"



RN301-BLK/AB
Finish: Black/Antique Brass



RN301-AB/SB
Finish: Antique Brass/Satin Brass

Fixture	Height	Depth	Base	Shade Material	LED	Shade Size
RN301-BLK/AB	69"	10"-18"	10"	metal	one 3000K 80+CRI 6.5 watt 600 lumen LED	2¼" × 4¼" × 5½"
RN301-AB/SB	69"	10"-18"	10"	metal	one 3000K 80+CRI 6.5 watt 600 lumen LED	2¼" × 4¼" × 5½"

Cord: 10' clear
Switch: on/off on shade
Clamp: adjusts from 0-2½"

River North



RN302-SN
Finish: Satin Nickel

Fixture	Height	Depth	Base	Shade Material	LED	Shade Size
RN302-SN	72"	17½"	10"	metal	One 2700K 90+CRI 4.5 watt 360 lumen LED	14" x 1"

Cord: 12' black
Switch: floor dimmer
Clamp: adjusts from 0–2½"



RU703-BLK (*Black and Satin Nickel*)

A simple powder coated series with metal accents, the Rupert collection will fit your transitional décor. This American Made series of floor lamps have dimming controls on the upright and table lamps come with USB ports.

Rupert



RU703-GT

Finish: Granite with Satin Nickel Accents



RU703-CHB

Finish: Chestnut Bronze with Weathered Brass Accents

Fixture	Height	Depth	Base	Shade Material	Bulb	Shade Size	Cord	Shade Number
RU703-GT	62"	17"	11"	white linen hardback	three 100W Type A	15" x 17" x 10½"	10' black	40433
RU703-CHB	62"	17"	11"	off-white linen hardback	three 100W Type A	15" x 17" x 10½"	10' brown	40432

Switch: full range dimmer on column



RU703-WT

Finish: White with Weathered Brass Accents



RU703-BLK

Finish: Black with Satin Nickel Accents

Fixture	Height	Depth	Base	Shade Material	Bulb	Shade Size	Cord	Shade Number
RU703-WT	62"	17"	11"	white linen hardback	three 100W Type A	15" x 17" x 10½"	10' clear	40433
RU703-BLK	62"	17"	11"	white linen hardback	three 100W Type A	15" x 17" x 10½"	10' black	40433

Switch: full range dimmer on column

Rupert



RU750-WT

Finish: White with Weathered Brass Accents



RU750-GT

Finish: Granite with Satin Nickel Accents



RU750-BLK

Finish: Black with Satin Nickel Accents



RU750-CHB

Finish: Chestnut Bronze with Weathered Brass Accents

Fixture	Height	Depth	Base	Shade Material	Bulb	Shade Size	Cord	Shade Number
RU750-CHB	30½"	16"	8" with USB port	off-white linen hardback	three 75W Type A	14" × 16" × 10½"	10' brown	40431
RU750-BLK	30½"	16"	8" with USB port	white linen hardback	three 75W Type A	14" × 16" × 10½"	10' black	40431A
RU750-GT	30½"	16"	8" with USB Port	white linen hardback	three 75W Type A	14" × 16" × 10½"	10' black	40431A
RU750-WT	30½"	16"	8" with USB Port	white linen hardback	three 75W Type A	14" × 16" × 10½"	10' clear	40431A
Switch: full range dimmer on column								



RU752-CHB

Finish: Chestnut Bronze with Weathered Brass Accents



RU752-BLK

Finish: Black with Satin Nickel Accents



RU751-GT

Finish: Granite with Satin Nickel Accents



RU751-WT

Finish: White with Weathered Brass Accents

Fixture	Height	Depth	Base	Shade Material	Bulb	Shade Size	Cord	Shade Number
RU752-CHB	19½"	9"	7" with USB port	white linen hardback	100W 3-way	9" x 9" x 10"	10' brown	40543AB
RU752-BLK	19½"	9"	7" with USB port	white linen hardback	100W 3-way	9" x 9" x 10"	10' black	40543N
RU751-GT	21"	9"	7" with USB port	white linen hardback	100W 3-way	9" x 9" x 10"	10' black	40543N
RU751-WT	21"	9"	7" with USB port	white linen hardback	100W 3-way	9" x 9" x 10"	10' clear	40543AB
Switch: on socket								

Sawyer

Additional Finish Option



Cobalt and Satin Nickel
(COSN)

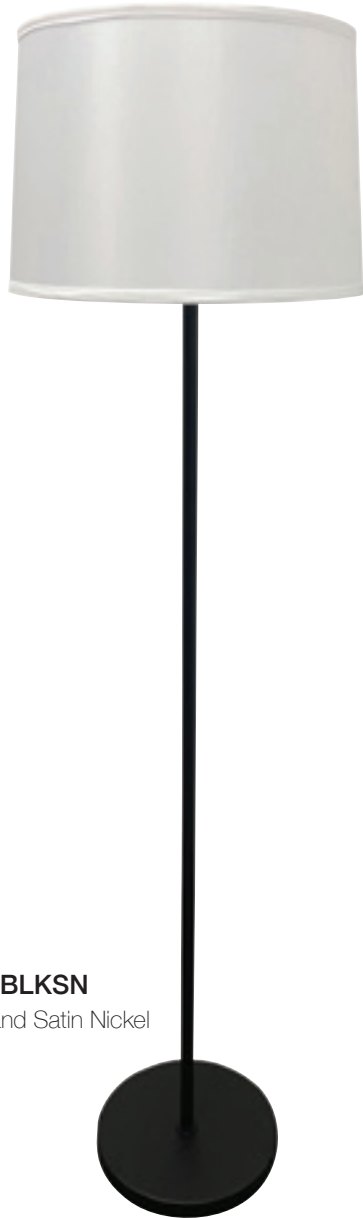

S500-BLKSN
Finish: Black and Satin Nickel



S500-CHBAB
Finish: Chestnut and Antique Brass

Fixture	Height	Width	Depth	Base	Shade Material	Bulb	Shade Size	Shade Number
S500-BLKSN	63"	16"	16"	10½"	fine white linen	150W 3-way	14" x 16" x 10"	40568N
S500-CHBAB	63"	16"	16"	10½"	fine white linen	150W 3-way	14" x 16" x 10"	40568N
S500-COSN	63"	16"	16"	10½"	fine white linen	150W 3-way	14" x 16" x 10"	40568N
Cord: 10' clear Switch: on socket								



S550-BLKSN
Finish: Black and Satin Nickel



S550-CHBAB
Finish: Chestnut and Antique Brass



S550-COSN
Finish: Cobalt and Satin Nickel

Fixture	Height	Width	Depth	Base	Shade Material	Bulb	Shade Size	Shade Number
S550-BLKSN	23"	11"	11"	7"	fine white linen	100W 3-way	9" x 11" x 8"	40566N
S550-CHBAB	23"	11"	11"	7"	fine white linen	100W 3-way	9" x 11" x 8"	40566N
S550-COSN	23"	11"	11"	7"	fine white linen	100W 3-way	9" x 11" x 8"	40566N
Cord: 10' clear Switch: on socket								

Sawyer

Additional Finish Option



Chestnut Bronze and
Antique Brass
(CHBAB)



S575-BLKSN
Finish: Black and Satin Brass



S575-COSN
Finish: Cobalt and Satin Nickel

Fixture	Height	Width	Depth	Base	Shade Material	Bulb	Shade Size	Shade Number
S575-BLKSN	14"	11"	15½"	5	fine white linen	100W 3-way	9" x 11" x 8"	40566N
S575-CHBAB	14"	11"	15½"	5	fine white linen	100W 3-way	9" x 11" x 8"	40566N
S575-COSN	14"	11"	15½"	5	fine white linen	100W 3-way	9" x 11" x 8"	40566N

Cord: 8' ivory with 30" cord cover
Switch: on socket



ST600-GT (*Granite*)

Our granite powdercoat finish on this industrial style floor, table and wall lamp create a look of modern chic. The clean look and small footprint make this the go to lamp for your loft. Made in Vermont makes this possible to request a custom finish in our powdercoat options.



ST650-GT
Finish: Granite

ST600-GT
Finish: Granite

ST675-GT
Finish: Granite

Pin-in Only

Fixture	Height	Depth	Base	Shade Material	Bulb	Shade Size	Shade Number
ST600-GT	63"	17"	16"	fine white linen hardback	one 150W 3-way	12" x 17" x 10½"	40452W
ST650-GT	29"	12½"	10½"	fine white linen hardback	one 150W 3-way	8½" x 12½" x 9½"	40443W
ST675-GT	18"	12½"	3"	fine white linen hardback	one 150W 3-way	8½" x 12½" x 9½"	40443W
Cord: 10' clear cord Switch: 3-way on socket							



T400-BLK/BB (*Black and Brushed Brass*)

The Taylor Collection has two-points of adjustment on the top of the column. This beauty is simple and sweet. It assists in creating the perfect light for a small area. Function and fashion at its best.

Taylor

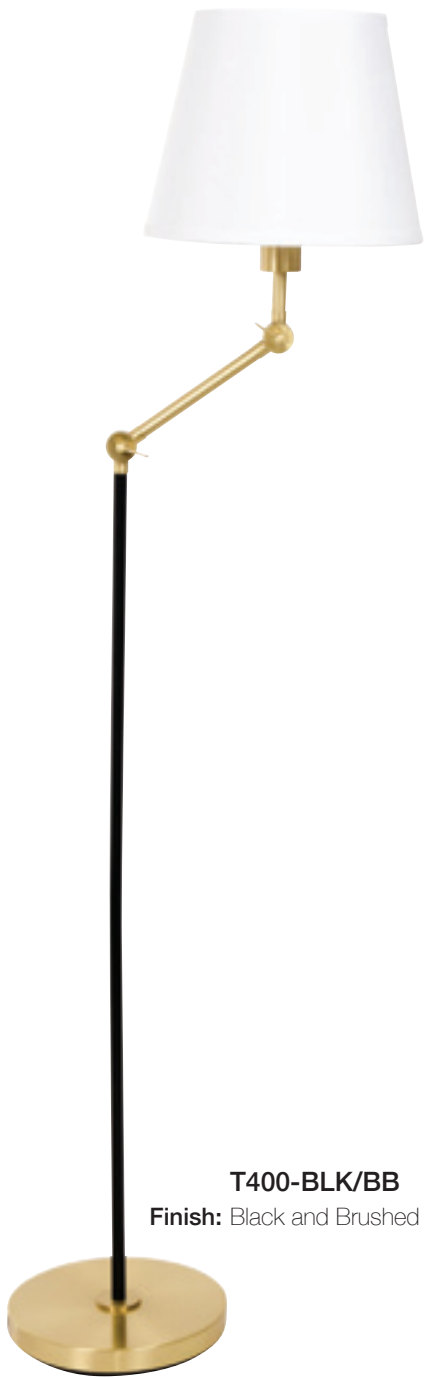

T400-BLK/BB
Finish: Black and Brushed Brass



T400-BLK/SN
Finish: Black and Satin Nickel

Fixture	Height	Depth	Base	Shade Material	Bulb	Shade Size	Cord	Shade Number
T400-BLK/BB	59"-62"	19"	10"	off-white hardback	60W type A	8" x 12" x 9½"	10' brown	40590
T400-BLK/SN	59"-62"	19"	10"	off-white hardback	60W type A	8" x 12" x 9½"	10' clear	40590N

Switch: on/off on socket

Town House



TH701-OB (*Oil Rubbed Bronze*)

Clean and contemporary yet functional. Town House is adjustable in height with a swing arm available in floor and wall. Table lamp is offered with or without convenience outlet on the base.

Town House



Fixture	Height	Extension	Base	Shade Material	Bulb	Shade Size	Cord	Shade Number
TH700-OB	adjusts 50" to 58"	extends 20"	10"	off-white linen hardback	one 100W 3-way	10" x 13" x 11"	10" brown	40412
TH700-PN	adjusts 50" to 58"	extends 20"	10"	off-white linen hardback	one 100W 3-way	10" x 13" x 11"	10' clear	40412N
TH700-RB	adjusts 50" to 58"	extends 20"	10"	off-white linen hardback	one 100W 3-way	10" x 13" x 11"	10' brown	40412
Switch: on socket								

Town House



TH701-RB
Finish: Raw Brass



TH701-OB
Finish: Oil Rubbed Bronze

Fixture	Height	Depth	Base	Shade Material	Bulb	Shade Size	Shade Number
TH701-RB	adjusts 46" to 58"	13"	10"	off-white linen hardback	one 100W 3-way	10" x 13" x 11"	40412
TH701-OB	adjusts 46" to 58"	13"	10"	off-white linen hardback	one 100W 3-way	10" x 13" x 11"	40412
Cord: 10' brown Switch: on socket							

Town House

TH725-OB
Finish: Oil Rubbed Bronze



TH725-PN
Finish: Polished Nickel



Fixture	Height	Extension	Back-plate	Shade Material	Bulb	Shade Size	Shade Number
TH725-OB	15"	26"	5"	off-white linen hardback	one 100W 3-way	10" x 12" x 9"	40413
TH725-PN	15"	26"	5"	off-white linen hardback	one 100W 3-way	10" x 12" x 9"	40413N
Cord: 10' clear with 30" cord cover Switch: on socket							

Town House



TH750-OB
Finish: Oil Rubbed Bronze



TH750-PN
Finish: Polished Nickel

Fixture	Height	Depth	Base	Shade Material	Bulb	Shade Size	Cord	Shade Number
TH750-OB	adjusts 23" to 28"	12"	7"	off-white linen hardback	one 100W 3-way	10" x 12" x 9"	10' brown	40413
TH750-PN	adjusts 23" to 28"	12"	7"	off-white linen hardback	one 100W 3-way	10" x 12" x 9"	10' clear	40413N
Switch: on socket								

Town House



TH751-RB

Finish: Raw Brass



TH751-OB

Finish: Oil Rubbed Bronze

Fixture	Height	Depth	Base	Shade Material	Bulb	Shade Size	Shade Number
TH751-RB	adjusts 23" to 28"	12"	7" with 120V convenience outlet	off-white linen hardback	one 100W 3-way	10" x 12" x 9"	40413
TH751-OB	adjusts 23" to 28"	12"	7" with 120V convenience outlet	off-white linen hardback	one 100W 3-way	10" x 12" x 9"	40413
Cord: 10' brown Switch: on socket							



TR201-BLK
Finish: Black

Fixture	Height	Base	Shade Material	Bulb	Shade Size	Shade Number
TR201-BLK	adjusts 46" to 60"	23"	white linen hardback	One 100W 3-way	16" x 18" x 11"	40562BLK
Cord: 9' clear Switch: on socket						

Uptown



UP502-NB/SB (*Navy Blue and Satin Brass*)

The Uptown offers diversity in style and function. The single or double pendant create a look of simplicity. If you need to offset the light from your electrical box this one will work. Our American Made product can be produced in custom lengths and custom finishes. Call Customer Service for a quote.



UP501-BLK/SN
Finish: Black/Silver Nickel



UP501-NB/SB
Finish: Navy Blue/Satin Brass



UP501-SB/PB
Finish: Satin Brass/Polished Brass

Fixture	Height	Depth	Canopy	Shade Material	Bulb	Shade Size	Shade Number
UP501-BLK/SN	41" max	adjustable from 14"-37"	5"	white linen hardback	one 100W type A	13" x 14" x 9"	40581N
UP501-SB/PB	41" max	adjustable from 14"-37"	5"	white linen hardback	one 100W type A	13" x 14" x 9"	40581N
UP501-NB/SB	41" max	adjustable from 14"-37"	5"	white linen hardback	one 100W type A	13" x 14" x 9"	40581N

Uptown



Fixture	Height	Depth	Canopy	Shade Material	Bulb	Shade Size	Shade Number
UP502-NB/SB	41" max	adjustable from 30"-59"	5" round	white linen hardback	two 100W type A	Two 13" x 14" x 9"	40581N
UP502-BLK/SN	41" max	adjustable from 30"-59"	5" round	white linen hardback	two 100W type A	Two 13" x 14" x 9"	40581N
UP502-SB/PB	41" max	adjustable from 30"-59"	5" round	white linen hardback	two 100W type A	Two 13" x 14" x 9"	40581N



VG450-AB

Finish: Antique Brass

Fixture	Height	Depth	Base	Shade Material	Bulb	Shade Size	Shade Number
VG450-AB	30"	13"	5½"	off-white monaco pleat softback	one 100W 3-way	6½" × 13" × 10"	40410
Cord: 10' brown Switch: on socket							

Vernon



VER500-PG (*Platinum Gray*)

This floor lamp provides optimal light with three 100W type A bulbs which operate on a full range dimmer. Powdercoat finishes and the thin metal table on the VER502 gives a look of sleekness. Our Vernon Collection is American Made and manufactured with pride.



VER500-BLK
Finish: Black

VER500-PG
Finish: Platinum Gray

VER500-WT
Finish: White

Fixture	Height	Depth	Base	Shade Material	Bulb	Shade Size	Shade Number
VER500-BLK	63½"	17"	10"	white linen hardback	three 100W Type A	12" × 17" × 10½"	40452W
VER500-PG	63½"	17"	10"	white linen hardback	three 100W Type A	12" × 17" × 10½"	40452W
VER500-WT	63½"	17"	10"	white linen hardback	three 100W Type A	12" × 17" × 10½"	40452W

Cord: 10' clear
Switch: full range dimmer on socket

Vernon



VER502-WT

Finish: White



VER502-PG

Finish: Platinum Gray



VER502-BLK

Finish: Black

Fixture	Height	Depth	Base	Shade Material	Bulb	Shade Size	Shade Number
VER502-WT	60¾"	17"	10"	white linen hardback	three 100W Type A	12" × 17" × 10½"	40452W
VER502-PG	60¾"	17"	10"	white linen hardback	three 100W Type A	12" × 17" × 10½"	40452W
VER502-BLK	60¾"	17"	10"	white linen hardback	three 100W Type A	12" × 17" × 10½"	40452W

Cord: 10' clear

Switch: full range dimmer on socket

Table: 12' diameter – 24" from floor



VIC925-BLK (*Black*)

The Victory Series floor and table lamps angle for the perfect illumination. The metal or fabric shade options give the illusion of warmth. This American Made family is simple and functional with a stable weighted base.

Victory

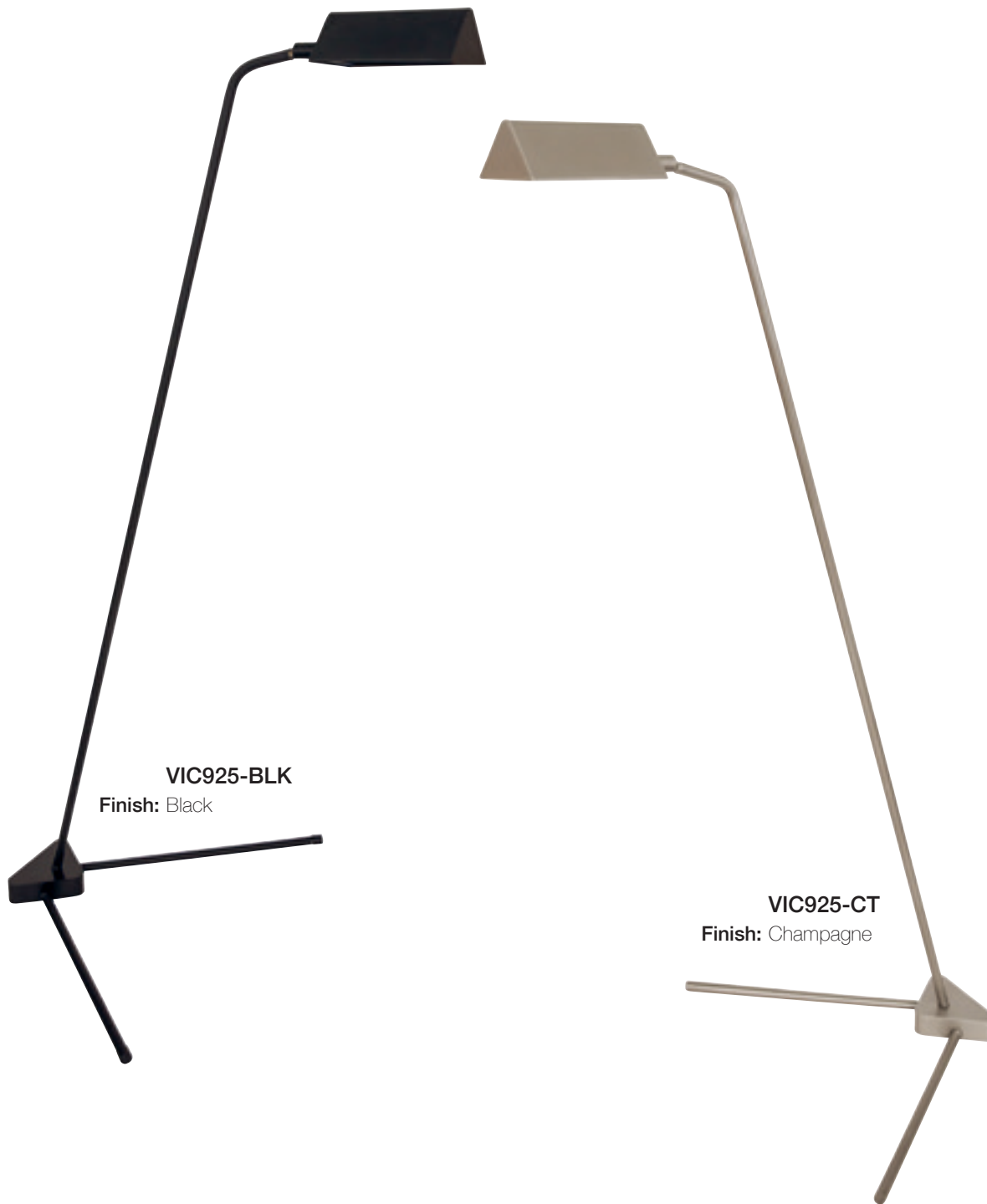

Fixture	Height	Base Extension	Shade Material	Bulb	Shade Size
VIC925-BLK	48"	17"	metal	one LED5W candelabra (included), 3000K, 90+ CRI, 5 Watts, 545 lumens	6½" × 4" × 2¼"
VIC925-CT	48"	17"	metal	one LED5W candelabra (included), 3000K, 90+ CRI, 5 Watts, 545 lumens	6½" × 4" × 2¼"
Cord: 10' clear Switch: full range dimmer on shade					



VIC950-BLK
Finish: Black



VIC950-CT
Finish: Champagne

Fixture	Height	Base Extension	Shade Material	Bulb	Shade Size
VIC950-BLK	16"	11"	metal	one LED5W candelabra (included), 3000K, 90+ CRI, 5 Watts, 545 lumens	6½" × 4" × 2¼"
VIC950-CT	16"	11"	metal	one LED5W candelabra (included), 3000K, 90+ CRI, 5 Watts, 545 lumens	6½" × 4" × 2¼"
Cord: 10' clear Switch: full range dimmer on shade					

Victory



VIC900-BLK
Finish: Black



VIC900-CT
Finish: Champagne

Fixture	Height	Base Extension	Shade Material	LED	Shade Size	Shade Number
VIC900-BLK	61¼"	17"	white linen hardback	one 100W 3-way	6" x 20" x 12"	40377
VIC900-CT	61¼"	17"	white linen hardback	one 100W 3-way	6" x 20" x 12"	40377
Cord: 10' clear Switch: on socket						

Wall Sconces



WL616-CB (*Chestnut Bronze*)

Wall sconces add ambient light to any room. Small and narrow, they work well in a dining room, bath or hallway.

Wall Sconces

Direct Wire Only



DSCLEDZ19-51
Finish: Satin Brass



DSCLEDZ19-52
Finish: Satin Nickel



DSCLEDZ19-61
Finish: Polished Brass



DSCLEDZ19-71
Finish: Antique Brass



DSCLEDZ19-91
Finish: Oil Rubbed Bronze

Fixture	Height	Extension	Backplate	Shade Material	LED	Shade Size
DSCLEDZ19-51	19"	4" (ADA compliant)	5"	metal	Integrated 2700K, 90 CRI, 4.5 Watts, 360 Lumens	14"
DSCLEDZ19-52	19"	4" (ADA compliant)	5"	metal	Integrated 2700K, 90 CRI, 4.5 Watts, 360 Lumens	14"
DSCLEDZ19-71	19"	4" (ADA compliant)	5"	metal	Integrated 2700K, 90 CRI, 4.5 Watts, 360 Lumens	14"
DSCLEDZ19-91	19"	4" (ADA compliant)	5"	metal	Integrated 2700K, 90 CRI, 4.5 Watts, 360 Lumens	14"
DSCLEDZ19-61	19"	4" (ADA compliant)	5"	metal	Integrated 2700K, 90 CRI, 4.5 Watts, 360 Lumens	14"

Wall Sconces

Plug-in Only



GR901-AB
Finish: Antique Brass



GR901-OB
Finish: Oil Rubbed Bronze



GR900-OB
Finish: Oil Rubbed Bronze

Fixture	Height	Extension	Backplate	Shade Material	Bulb	Shade Size	Shade Number
GR901-AB	13"	11¼"	5¼"	off-white linen hardback	one 60W B10	6" x 9" x 7"	40370
GR901-OB	13"	11¼"	5¼"	off-white linen hardback	one 60W B10	6" x 9" x 7"	40370
GR900-OB	11"	8¾"	3¼" x 5"	off-white linen hardback	one 60W B10	4" x 7¼" x 6"	40210

Cord: 10' clear
Switch: on/off in-line, 19" from backplate

Wall Sconces

Direct Wire Only



LS206-SP

Finish: Satin Pewter



LS206-MB

Finish: Mahogany Bronze



LS206-AB

Finish: Antique Brass

Fixture	Height	Extension	Backplate	Bulb	Shade Material	Shade Size	Glass Number
LS206-SP	9"	4"	9" x 5"	60WB10	clear seedy glass cylinder	6" x 3"	40579
LS206-MB	9"	4"	9" x 5"	60WB10	clear seedy glass cylinder	6" x 3"	40579
LS206-AB	9"	4"	9" x 5"	60WB10	clear seedy glass cylinder	6" x 3"	40579

Wall Sconces

Direct Wire Only



LS217-AB
Finish: Antique Brass



LS217-MB
Finish: Mahogany Bronze



LS217-SP
Finish: Satin Pewter

Fixture	Height	Extension	Backplate	Shade Material	Bulb	Shade Size	Shade Number
LS217-AB	11½"	8"	7" x 5"	cream linen hardback	60WB10	4" x 6" x 6"	40216C
LS217-MB	11½"	8"	7" x 5"	natural linen hardback	60WB10	4" x 6" x 6"	40216N
LS217-SP	11½"	8"	7" x 5"	white linen hardback	60WB10	4" x 6" x 6"	40216W

Wall Sconces

Cover plate provided for standard junction box when necessary.

Direct Wire Only



WL601-PC
Finish: Polished Chrome



WL601-OB
Finish: Oil Rubbed Bronze



WL601-SN
Finish: Satin Nickel

Fixture	Height	Extension	Backplate	Shade Material	Bulb	Shade Size	Shade Number
WL601-PC	10¼"	4" (ADA compliant)	2¾" x 4½"	white glass	one 60WT10	7¾" x 1⅞"	44503
WL601-OB	10¼"	4" (ADA compliant)	2¾" x 4½"	amber glass	one 60WT10	7¾" x 1⅞"	44505
WL601-SN	10¼"	4" (ADA compliant)	2¾" x 4½"	white glass	one 60WT10	7¾" x 1⅞"	44503

Wall Sconces

Direct Wire Only

Cover plate provided for standard junction box when necessary.



WL609-SN
Finish: Satin Nickel



WL609-SB
Finish: Satin Brass

Fixture	Height	Extension	Backplate	Shade Material	Bulb	Shade Size	Shade Number
WL609-SN	13¾"	7½"	2¼" × 4½"	white softback	one 60WB10 Candelabra	4⅞" × 7" × 5¾"	40237
WL609-SB	13¾"	7½"	2¼" × 4½"	off-white softback	one 60WB10 Candelabra	4⅞" × 7" × 5¾"	40237

Wall Sconces

Direct Wire Only



WL616-CB
Finish: Copper Bronze



WL616-PB
Finish: Polished Brass



WL616-AB
Finish: Antique Brass

Fixture	Height	Extension	Backplate	Shade Material	Bulb	Shade Size	Shade Number
WL616-CB	19"	7"	4 $\frac{1}{8}$ "	off-white softback	two 60WB10 Candelabra	7 $\frac{1}{4}$ " x 9 $\frac{1}{4}$ " x 4 $\frac{1}{2}$ "	40430
WL616-PB	19"	7"	4 $\frac{1}{8}$ "	off-white softback	two 60WB10 Candelabra	7 $\frac{1}{4}$ " x 9 $\frac{1}{4}$ " x 4 $\frac{1}{2}$ "	40430
WL616-AB	19"	7"	4 $\frac{1}{8}$ "	off-white softback	two 60WB10 Candelabra	7 $\frac{1}{4}$ " x 9 $\frac{1}{4}$ " x 4 $\frac{1}{2}$ "	40430

Wall Sconces

Direct Wire Only



Fixture	Height	Extension	Backplate	Shade Material	Bulb	Shade Size	Shade Number
WL625-SN	15"	8"	4½" x 4½" with 120V convenience outlet	white linen hardback	one 60W medium	6" x 6" x 7"	40525N
WL625-OB	15"	8"	4½" x 4½" with 120V convenience outlet	off-white linen hardback	one 60W medium	6" x 6" x 7"	40525
Switch: on/off on backplate							

Wall Sconces

Direct Wire Only



WL631-SN
Finish: Satin Nickel



WL631-ABZ
Finish: Architectural Bronze

Fixture	Height	Extension	Backplate	Shade Material	Bulb	Shade Size	Shade Number
WL631-SN	11½"	4" (ADA compliant)	4½" x 4½"	cream linen hardback	40W B10	(7" x 3½") x (7" x 3½") x 7"	40372
WL631-ABZ	11½"	4" (ADA compliant)	4½" x 4½"	cream linen hardback	40W B10	(7" x 3½") x (7" x 3½") x 7"	40372

Wall Sconces

Direct Wire Only

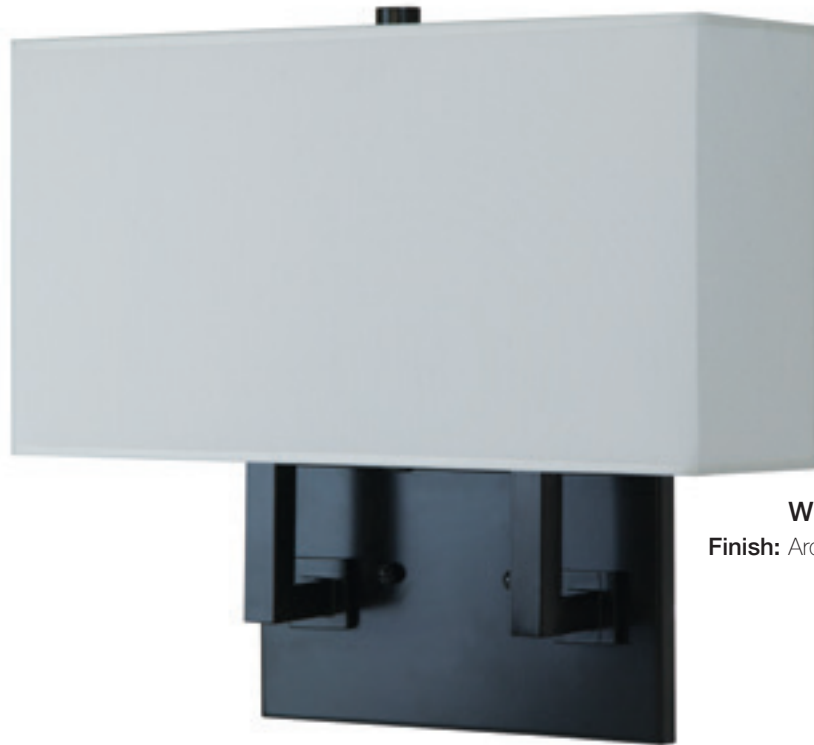

WL632-ABZ
Finish: Architectural Bronze



WL632-SN
Finish: Satin Nickel

Fixture	Height	Extension	Backplate	Shade Material	Bulb	Shade Size	Shade Number
WL632-ABZ	11½"	4" (ADA compliant)	4½" x 8"	cream linen hardback	two 40W B10	(14½" x 3½") x (14½" x 3½") x 7"	40373
WL632-SN	11½"	4" (ADA compliant)	4½" x 8"	cream linen hardback	two 40W B10	(14½" x 3½") x (14½" x 3½") x 7"	40373

Wall Swing Arms



WS776-PN (*Polished Nickel*)

Our Wall Swing Arm lamps are functional beside a bed or couch. They extend to allow for maximum adjustability. We offer various styles for all décors.

Wall Swing Arms

Direct Wire Only



DL20-OB
Finish: Oil Rubbed Bronze



DL20-WB
Finish: Weathered Brass

Fixture	Height	Extension	Backplate	Shade Material	Bulb	Shade Size	Shade Number
DL20-OB	12"	25"	4½" x 4½"	off-white linen hardback	one 100W Type A	5" x 9" x 7"	40277
DL20-WB	12"	25"	4½" x 4½"	black parchment	one 100W Type A	5" x 9" x 7"	40275

Wall Swing Arms

PL20-WB
Finish: Weathered Brass



PL20-OB
Finish: Oil Rubbed Bronze



Fixture	Height	Extension	Backplate	Shade Material	Bulb	Shade Size	Shade number
PL20-WB	12½"	26"	5"	black parchment	one 100W Type A	5" × 9" × 7"	40275
PL20-OB	12½"	26"	5"	off-white linen hardback	one 100W Type A	5" × 9" × 7"	40275

Cord: 10' ivory with 30" cord cover
Switch: full range dimmer on backplate

Wall Swing Arms

Plug-in Only



LL660-OB
Finish: Oil Rubbed Bronze



LL660-AB
Finish: Antique Brass



LL660-PB
Finish: Polished Brass

Fixture	Height	Extension	Backplate	Shade Material	Bulb	Shade Size	Shade Number
LL660-OB	13"	11½"	1¼" × 3½"	off-white softback	one 60W medium base	5" × 10" × 6¾"	40287
LL660-PB	13"	11½"	1¼" × 3½"	off-white softback	one 60W medium base	5" × 10" × 6¾"	40289
LL660-AB	13"	11½"	1¼" × 3½"	off-white softback	one 60W medium base	5" × 10" × 6¾"	40287

Cord: 11' clear with 30" cord cover
Switch: on/off on socket

Wall Swing Arms

Pin-up Only



WS706-AB
Finish: Antique Brass



WS-706
Finish: Polished Brass



WS706-OB
Finish: Oil Rubbed Bronze

Fixture	Height	Extension	Backplate	Shade Material	Bulb	Shade Size	Shade Number
WS706-AB	16½"	25"	6¼" × 3½"	off-white softback	one 100W 3-way	5½" × 12" × 8½"	40385
WS706-OB	16½"	25"	6¼" × 3½"	off-white softback	one 100W 3-way	5½" × 12" × 8½"	40385
WS-706	16½"	25"	6¼" × 3½"	off-white softback	one 100W 3-way	5½" × 12" × 8½"	40385
Cord: 11' ivory with 30" cord cover Switch: on socket							

Wall Swing Arms

Pin-up Only



WS-704

Finish: Polished Brass



WS708-OB

Finish: Oil Rubbed Bronze

Fixture	Height	Extension	Backplate	Shade Material	Bulb	Shade Size	Switch	Shade Number
WS-704	13"	25"	6¼" x 3½"	off-white linen hardback with diffuser	one 100W Type A	7" x 13½" x 7½"	full range dimmer on socket	40379
WS708-OB	16"	25"	6¼" x 3½"	off-white softback	one 100W Type A	5½" x 12" x 8½"	hi-lo on backplate	40385
Cord: 11' ivory with 30" cord cover								

Wall Swing Arms



WS750-AS
Finish: Antique Silver



WS750-OB
Finish: Oil Rubbed Bronze



WS750-AB
Finish: Antique Brass

Fixture	Height	Extension	Backplate	Shade Material	Bulb	Shade Size	Shade Number
WS750-AS	15"	27"	5" x 6"	white linen hardback	one 100W 3-way	6" x 11" x 8"	40312
WS750-OB	15"	27"	5" x 6"	off-white linen hardback	one 100W 3-way	6" x 11" x 8"	40310
WS750-AB	15"	27"	5" x 6"	off-white linen hardback	one 100W 3-way	6" x 11" x 8"	40310
Cord: 11' clear with 30" cord cover Switch: on socket							

Wall Swing Arms



WS751-AB
Finish: Antique Brass



WS751-OB
Finish: Oil Rubbed Bronze



WS751-AS
Finish: Antique Silver

Fixture	Height	Extension	Backplate	Shade Material	Bulb	Shade Size	Shade Number
WS751-AB	15"	23"	6" x 6"	off-white linen hardback	one 100W 3-way	6" x 9" x 8½"	40420
WS751-AS	15"	23"	6" x 6"	white linen hardback	one 100W 3-way	6" x 9" x 8½"	40421
WS751-OB	15"	23"	6" x 6"	off-white linen hardback	one 100W 3-way	6" x 9" x 8½"	40420

Cord: 11' clear with 30" cord cover
Switch: on socket

Wall Swing Arms

WS752-OB
Finish: Oil Rubbed Bronze



WS752-AS
Finish: Antique Silver



WS752-AB
Finish: Antique Brass



Fixture	Height	Extension	Backplate	Shade Material	Bulb	Shade Size	Shade Number
WS752-OB	14"	25"	4 ³ / ₄ " x 4 ³ / ₄ "	off-white linen hardback	one 100W 3-way	8" x 9" x 8"	40445
WS752-AS	14"	25"	4 ³ / ₄ " x 4 ³ / ₄ "	white linen hardback	one 100W 3-way	8" x 9" x 8"	40446
WS752-AB	14"	25"	4 ³ / ₄ " x 4 ³ / ₄ "	off-white linen hardback	one 100W 3-way	8" x 9" x 8"	40445
Cord: 11' clear with 30" cord cover Switch: on socket							

Wall Swing Arms

WS761-OB
Finish: Oil Rubbed Bronze



WS761-AS
Finish: Antique Silver



WS761-AB
Finish: Antique Brass

Fixture	Height	Extension	Backplate	Shade Material	Bulb	Shade Size	Shade Number
WS761-OB	18"	25"	4½" × 6"	off-white linen softback	one 100W Type A	6½" × 12" × 9½"	40423A
WS761-AS	18"	25"	4½" × 6"	white linen softback	one 100W Type A	6½" × 12" × 9½"	40423B
WS761-AB	18"	25"	4½" × 6"	off-white linen softback	one 100W Type A	6½" × 12" × 9½"	40423A
Cord: 10' clear with 30" cord cover Switch: on/off on socket							

Wall Swing Arms



WS775-SN

Finish: Satin Nickel



WS775-OB

Finish: Oil Rubbed Bronze



WS720-OB

Finish: Oil Rubbed Bronze

Fixture	Height	Extension	Backplate	Shade Material	Bulb	Shade Size	Switch	Shade Number
WS775-SN	15"	24"	5"	white linen hardback	100W 3-way	8" x 8" x 9"	on socket	40570N
WS775-OB	15"	24"	5"	off-white linen hardback	100W 3-way	8" x 8" x 9"	on socket	40570
WS720-OB	11½"	19½"	4½" x 4½"	off-white linen hardback	One 100W Type A	8½" x 9½" x 7" with diffuser	full range dimmer on socket	40388
Cord: 10' clear with 30" cord cover								

Wall Swing Arms



WS776-OB

Finish: Oil Rubbed Bronze



WS776-PN

Finish: Polished Nickel

Fixture	Height	Extension	Backplate	Shade Material	Bulb	Shade Size	Shade Number
WS776-OB	12½"	25½"	4½" × 6"	off-white linen hardback	100W medium	11½" × 12" × 6" with diffuser	40571
WS776-PN	12½"	25½"	4½" × 6"	white linen hardback	100W medium	11½" × 12" × 6" with diffuser	40571N

Cord: 11' clear with 30" cord cover
Switch: full range dimmer on backplate

Wall Swing Arms



WS16-91
Finish: Oil Rubbed Bronze



WS16-31
Finish: Pewter



WS731-ABBLK
Finish: Antique Brass with Black Accents

Fixture	Height	Extension	Backplate	Shade Material	Bulb	Shade Size	Shade Number
WS16-91	15½"	25"	6" × 4½"	off-white linen hardback	one 100W Type A	5½" × 12½" × 9¼"	40387
WS16-31	15½"	25"	6" × 4½"	white linen hardback	one 100W Type A	5½" × 12½" × 9¼"	40389
WS731-ABBLK	19"	24"-33"	3" × 12"	off-white linen hardback	one 100W 3-way	6" × 18" × 10"	40390
Cord: 10' clear with 30" cord cover Switch: on socket							

Wall Swing Arms

Pin-up Only



WL630-ABZ
Finish: Architectural Bronze



WL630-SN
Finish: Satin Nickel

Fixture	Height	Extension	Backplate	Shade Material	Bulb	Shade Size	Cord	Shade Number
WL630-ABZ	16"	16½"	6" × 2¾"	cream linen hardback	100W Type A	8" × 9" × 8"	10' brown	40371
WL630-SN	16"	16½"	6" × 2¾"	cream linen hardback	100W Type A	8" × 9" × 8"	10' silver	40371
Switch: pull chain								

Windsor



W401-OB (*Oil Rubbed Bronze*)

If you are looking for a light that is large in stature and makes a statement, the Windsor Collection is the one. These imported floor lamps will enhance any room with height adjustment and stylish elements. Let the focal point of these lamps enhance your décor.

Windsor



W401-AB
Finish: Antique Brass



W401-OB
Finish: Oil Rubbed Bronze

Fixture	Height	Extension	Base	Shade Material	Bulb	Shade Size	Shade Number
W401-AB	45"-61"	35"	13"	off-white linen hardback	one 150W 3-way	17" x 18" x 10"	40580
W401-OB	45"-61"	35"	13"	off-white linen hardback	one 150W 3-way	17" x 18" x 10"	40580
Cord: 10' brown, exits from adjustment arm Switch: on socket							

Windsor



W400-OB
Finish: Oil Rubbed Bronze

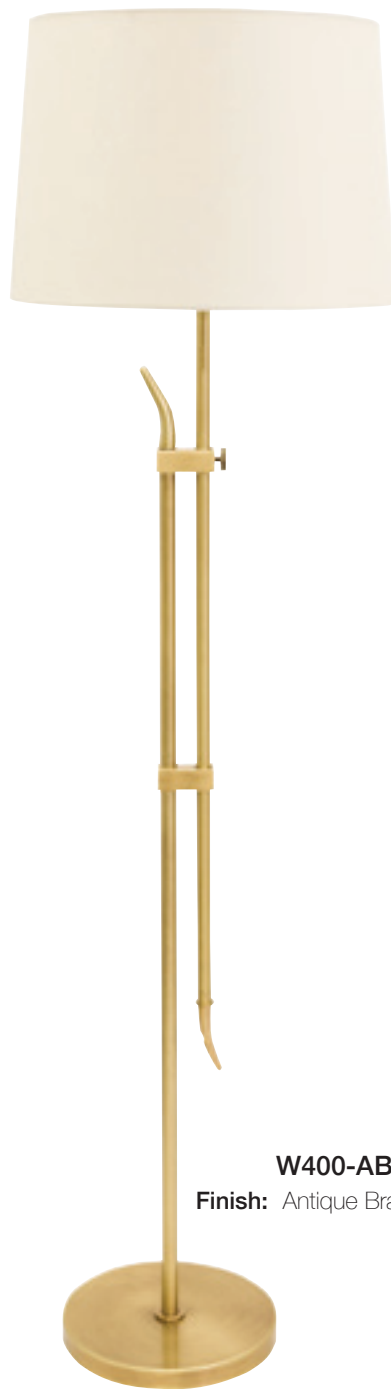

W400-AB
Finish: Antique Brass

Fixture	Height	Depth	Base	Shade Material	Bulb	Shade Size	Shade Number
W400-OB	61"	16"	8"	white linen hardback	one 150W 3-way	14" x 16" x 11"	40587
W400-AB	61"	16"	8"	off-white linen hardback	one 150W 3-way	14" x 16" x 11"	40587
Cord: 10' brown, exits from adjustment arm Switch: on socket							



WOL400-PN (*Polished Nickel*)

The sweet and simple Wolcott floor lamp comes in either an oiled rubbed bronze or polished nickel finish. This imported lamp with an angled arm extension is a necessary stylish accent to any room.



Fixture	Height	Extension	Base	Shade Material	Bulb	Shade Size	Cord	Shade Number
WOL400-OB	61 ³ / ₄ "	13 ¹ / ₂ "	10 ¹ / ₂ "	off-white linen hardback	one 100W 3-way	7 ¹ / ₂ " x 8 ¹ / ₂ " x 11"	10' brown	40398
WOL400-PN	61 ³ / ₄ "	13 ¹ / ₂ "	10 ¹ / ₂ "	white linen hardback	one 100W 3-way	7 ¹ / ₂ " x 8 ¹ / ₂ " x 11"	10' clear	40398N
Switch: on socket								

Desk/Piano Lamps



P14-231-71 (*Antique Brass*)

House of Troy desk/upright piano lamps illuminate any task with efficiency and classic good looks. Features include multiple points of adjustment, easy switching and excellent light output.

Desk/Piano Lamps



AP10-20-71
Finish: Antique Brass



AP10-20-61
Finish: Polished Brass



AP10-20-7
Finish: Black



AP10-25-7
Finish: Black

Fixture	Height	Depth	Base	Shade Material	Bulb	Shade Size	Cord
AP10-20-71	maximum 11½"	10"	5"	metal	one 40T10	10"	9' brown
AP10-20-61	maximum 11½"	10"	5"	metal	one 40T10	10"	9' brown
AP10-20-7	maximum 11½"	10"	5"	metal	one 40T10	10"	9' black
AP10-25-7	maximum 10"	10"	6"	metal	one 40T10	10"	9' black
Switch: on/off on shade							

Desk/Piano Lamps



AP10-21-7
Finish: Black



AP10-21-91
Finish: Oil Rubbed Bronze



AP10-21-61
Finish: Polished Brass



AP10-21-71
Finish: Antique Brass

Fixture	Height	Depth	Base	Shade Material	Bulb	Shade Size	Cord
AP10-21-7	maximum 10½"	10"	5"	metal	one 40T10	10"	9' black
AP10-21-91	maximum 10½"	10"	5"	metal	one 40T10	10"	9' brown
AP10-21-61	maximum 10½"	10"	5"	metal	one 40T10	10"	9' brown
AP10-21-71	maximum 10½"	10"	5"	metal	one 40T10	10"	9' brown
Switch: on/off on shade							

Desk/Piano Lamps



AP14-41-7
Finish: Black



AP14-41-71
Finish: Antique Brass



AP14-40-7
Finish: Black

Fixture	Height	Depth	Base	Shade Material	Bulb	Shade Size	Cord
AP14-41-71	maximum 12"	14"	6"	metal	two 40T10	14"	9' brown
AP14-41-7	maximum 12"	14"	6"	metal	two 40T10	14"	10' black
AP14-40-7	maximum 12½"	14"	6"	metal	two 40T10	14"	9' black
Switch: on/off in-line 6" from base							

Desk/Piano Lamps



AP14-41-91

Finish: Oil Rubbed Bronze



AP14-45-7

Finish: Black

Fixture	Height	Depth	Base	Shade Material	Bulb	Shade Size
AP14-41-91	maximum 12"	14"	6"	metal	two 40T10	14"
AP14-45-7	maximum 10"	14"	6"	metal	two 40T10	14"
<p>Cord: 9' black Switch: on/off in-line 6" from base</p>						

Desk/Piano Lamps



P10-111-71
Finish: Antique Brass



P10-111
Finish: Polished Brass



P10-111-MB
Finish: Mahogany Bronze



P10-101-B
Finish: Polished Brass & Black Marble

Marble is a natural material and therefore, each piece will have variations.

Fixture	Height	Depth	Base	Shade Material	Bulb	Shade Size
P10-101-B	maximum 12"	10"	4½"	metal	one 40T10 or 60T10	10"
P10-111-71	maximum 14"	10"	5¾" octagon	metal	one 40T10 or 60T10	10"
P10-111-MB	maximum 14"	10"	5¾" octagon	metal	one 40T10 or 60T10	10"
P10-111	maximum 14"	10"	5¾" octagon	metal	one 40T10 or 60T10	10"
Cord: 9' brown Switch: on/off on shade						

Desk/Piano Lamps



P10-130
Finish: Polished Brass



P10-131-61
Finish: Polished Brass



P10-131-71
Finish: Antique Brass

Fixture	Height	Depth	Base	Shade Material	Bulb	Shade Size
P10-130	maximum" 11"	10"	5"	metal	one 40T10 or 60T10	10"
P10-131-61	maximum 10½"	10"	5"	metal	one 40T10 or 60T10	10"
P10-131-71	maximum 10½"	10"	5"	metal	one 40T10 or 60T10	10"
Cord: 9' brown Switch: on/off on shade						

Desk/Piano Lamps



P14-201-GT
Finish: Granite



P14-201
Finish: Polished Brass



P14-201-81
Finish: Mahogany Bronze



P14-201-AB
Finish: Antique Brass

Fixture	Height	Depth	Base	Shade Material	Bulb	Shade Size
P14-201	maximum 14"	10"	6"	metal	two 40T10 or 60T10	14"
P14-201-GT	maximum 14"	10"	6"	metal	two 40T10 or 60T10	14"
P14-201-81	maximum 14"	10"	6"	metal	two 40T10 or 60T10	14"
P14-201-AB	maximum 14"	10"	6"	metal	two 40T10 or 60T10	14"
Cord: 9' brown Switch: on/off on base						

Desk/Piano Lamps



P14-202
Finish: Polished Brass



P14-202-81
Finish: Mahogany Bronze



P14-202-AB
Finish: Antique Brass

Fixture	Height	Depth	Base	Shade Material	Bulb	Shade Size
P14-202-81	maximum 13"	14"	5"	metal	two 40T10 or 60T10	14"
P14-202	maximum 13"	14"	5"	metal	two 40T10 or 60T10	14"
P14-202-AB	maximum 13"	14"	5"	metal	two 40T10 or 60T10	14"
Cord: 9' brown Switch: on/off on base						

Desk/Piano Lamps



P14-203-81
Finish: Mahogany Bronze



P14-203
Finish: Polished Brass



P14-203-AB
Finish: Antique Brass

Fixture	Height	Depth	Base	Shade Material	Bulb	Shade Size
P14-203	maximum 12½"	14"	6" octagon	metal	two 40T10 or 60T10	14"
P14-203-81	maximum 12½"	14"	6" octagon	metal	two 40T10 or 60T10	14"
P14-203-AB	maximum 12½"	14"	6" octagon	metal	two 40T10 or 60T10	14"
Cord: 9' brown Switch: on/off on base						

Desk/Piano Lamps



P14-204
Finish: Polished Brass



P14-204-81
Finish: Mahogany Bronze



P14-204-AB
Finish: Antique Brass

Fixture	Height	Depth	Base	Shade Material	Bulb	Shade Size
P14-204	maximum 15"	14"	6¼"	metal	two 40T10 or 60T10	14"
P14-204-81	maximum 15"	14"	6¼"	metal	two 40T10 or 60T10	14"
P14-204-AB	maximum 15"	14"	6¼"	metal	two 40T10 or 60T10	14"

Cord: 9' brown
Switch: on/off on base

Desk/Piano Lamps



P14-232-C71
Finish: Antique Brass
 & Chestnut Bronze



P14-231-71
Finish: Antique Brass



P14-231-61
Finish: Polished Brass

Fixture	Height	Depth	Base	Shade Material	Bulb	Shade Size	Switch
P14-232-C71	maximum 14 ³ / ₄ "	14"	5 ¹ / ₈ "	metal	two 40T10 or 60T10	14"	on/off on base
P14-231-71	maximum 12"	14"	6"	metal	two 40T10 or 60T10	14"	on/off in-line 6" from base
P14-231-61	maximum 12"	14"	6"	metal	two 40T10 or 60T10	14"	on/off in-line 6" from base
Cord: 9' brown							

Desk/Piano Lamps



P14-233-617

Finish: Black with Polished Brass Accents



P14-233-C71

Finish: Antique Brass & Chestnut Bronze



Fixture	Height	Depth	Base	Shade Material	Bulb	Shade Size	Cord
P14-233-617	maximum 16½"	14"	5⅞" square	metal	two 40T10 or 60T10	14"	9' black
P14-231-71	maximum 16½"	14"	5⅞" square	metal	two 40T10 or 60T10	14"	9' brown
Switch: on/off on base							

Desk/Piano Lamps

Marble is a natural material and therefore, each piece will have variations.



P15-83-52
Finish: Satin Nickel



P14-280-WB
Finish: Weathered Brass & Black & Tan Marble



P14-280
Finish: Mahogany Bronze & Black & Tan Marble

Fixture	Height	Depth	Base	Shade Material	Bulb	Shade Size	Cord
P15-83-52	maximum 16"	15"	5¾" square	metal	two 40T10 or 60T10	15"	9' clear
P14-280-WB	maximum 12"	14"	5⅝" square	metal	two 40T10 or 60T10	14"	9' brown
P14-280	maximum 12"	14"	5⅝" square	metal	two 40T10 or 60T10	14"	9' brown
Switch: on/off on base							

Desk/Piano Lamps

Marble is a natural material and therefore, each piece will have variations.



DSK428-G61
Finish: Polished Brass



DSK428-G71
Finish: Antique Brass



DSK430-MB
Finish: Mahogany Bronze & Black & Tan Marble



DSK500-BLKPN
Finish: Matte Black with Polished Nickel Accents

Fixture	Height	Depth	Base	Shade Material	Bulb	Shade Size	Cord	Switch
DSK428-G71	13¾"	9½"	5"	green glass	one 60T10	9"	9' brown	on/off on base
DSK428-G61	13¾"	9½"	5"	green glass	one 60T10	9"	9' brown	on/off on base
DSK430-MB	13¾"	9½"	5"	amber glass	one 60T10	9"	9' brown	on/off on base
DSK500-BLKPN	adjusts to 19½" max	7½"	8"	metal	LED: 3500K, 85CRI, 8W, 640 Lumens	14"	10' black and white houndstooth	dimmer on back of shade

Specialty Desk/Piano Lamps



P10-150-617 (Black and Polished Brass)

Every music teacher will tell you how important good lighting is when reading music. Our piano lamps are designed to accommodate all styles of acoustic pianos, from Upright to Grand.

Specialty Desk/Piano Lamps



P10-150

Finish: Polished Brass

P14-250

Finish: Polished Brass

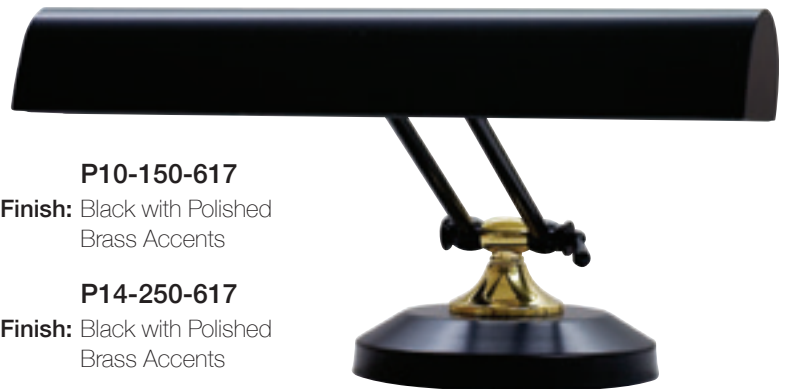

P10-150-617

Finish: Black with Polished Brass Accents

P14-250-617

Finish: Black with Polished Brass Accents



PH10-170-PB

Finish: Polished Brass

Fixture	Height	Extension	Base	Shade Material	Bulb	Shade Size	Cord	Switch
P10-150	maximum 8"	9"	6"	metal	one 40T10 or 60T10	10"	9' brown	on/off on shade
P14-250	maximum 8"	9"	6"	metal	two 40T10 or 60T10	14"	9' brown	on/off in-line 6" from base
P10-150-617	maximum 8"	9"	6"	metal	one 40T10 or 60T10	10"	9' black	on/off on shade
P14-250-617	maximum 8"	9"	6"	metal	two 40T10 or 60T10	14"	9' black	in-line 6" from base
PH10-170-PB	maximum 6"	8½"	6"	metal	50W GU10 halogen (included)	10"	10' black	full range dimmer on shade

Specialty Desk/Piano Lamps



PLED101-527
Finish: Black with
 Satin Nickel Accents



PLED101-61
Finish: Polished Brass



PLED101-617
Finish: Black with
 Brass Accents

Fixture	Height	Extension	Base	Shade Material	LED	Shade Size
PLED101-527	4"	5¼"	5¼"	metal	Integrated 3000K, 80 CRI, 4.7 Watts, 200 Lumens	19"
PLED101-61	4"	5¼"	5¼"	metal	Integrated 3000K, 80 CRI, 4.7 Watts, 200 Lumens	19"
PLED101-617	4"	5¼"	5¼"	metal	Integrated 3000K, 80 CRI, 4.7 Watts, 200 Lumens	19"
Cord: 10' with plug-in driver Switch: on/off in-line 6" from base						

Specialty Desk/Piano Lamps



P16-DO2-627
Finish: Chrome and Black



P16-DO2-617
Finish: Polished Brass and Black

Fixture	Height	Extension	Base	Shade Material	Bulb	Shade Size
P16-DO2-627	15"	5¼"	3½" × 7"	metal	two 40T10 or 60T10	14"
P16-DO2-617	15"	5¼"	3½" × 7"	metal	two 40T10 or 60T10	14"
Cord: 9" black Switch: on/off in-line 6" from base						

Specialty Desk/Piano Lamps



PLED100-61
Finish: Polished Brass



PLED100-527
Finish: Black with Satin
Nickel Accents



PLED100-617
Finish: Black with
Polished Brass Accents

Fixture	Height	Depth	Base	Shade Material	LED	Shade Size
PLED100-61	16"	19"	5¼"	metal	Integrated 3000K, 80 CRI, 4.7 Watts, 200 Lumens	19"
PLED100-527	16"	19"	5¼"	metal	Integrated 3000K, 80 CRI, 4.7 Watts, 200 Lumens	19"
PLED100-617	16"	19"	5¼"	metal	Integrated 3000K, 80 CRI, 4.7 Watts, 200 Lumens	19"
<p>Cord: 10' black with plug-in driver Switch: on/off in-line 6" from base</p>						

Specialty Desk/Piano Lamps



CBLED12-7
Finish: Black



CBLED12-61
Finish: Polished Brass

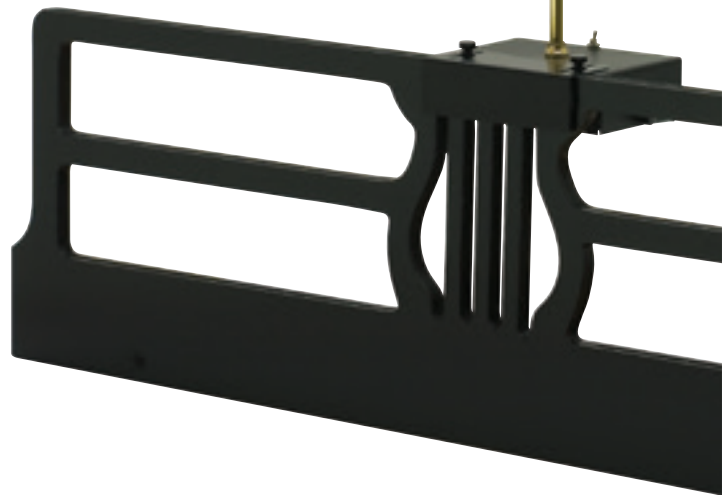

Fixture	Height	Depth	Extension	Base	Shade Material	LED	Shade Size
CBLED12-7	5½"	12½"	4½"	4½" × 3" × 1¼"	metal	Integrated 3000K, 75 CRI, 3.2 Watts, 88 Lumens	12½"
CBLED12-61	5½"	12½"	4½"	4½" × 3" × 1¼"	metal	Integrated 3000K, 75 CRI, 3.2 Watts, 88 Lumens	12½"

Batteries: 4C (not included) illuminates 48 hours

Switch: on/off on base

Clamp: adjusts from 0 – 1"

Specialty Piano Lamps



GP10-81
Finish: Mahogany Bronze



GP10-7
Finish: Black



GP10-61
Finish: Polished Brass

Fixture	Height	Depth	Clamp	Shade Material	Bulb	Shade Size	Cord
GP10-81	adjustable 8½" gooseneck	10"	5½" × 2½"	metal	one 40T10 or 60T10	10"	9' brown
GP10-7	adjustable 8½" gooseneck	10"	5½" × 2½"	metal	one 40T10 or 60T10	10"	9' black
GP10-61	adjustable 8½" gooseneck	10"	5½" × 2½"	metal	one 40T10 or 60T10	10"	9' brown

Switch: on/off on shade
Clamp: adjusts from ½" – ¾"

Specialty Piano Lamps



GP14-81
Finish: Mahogany Bronze



GP14-7
Finish: Black



GP14-61
Finish: Polished Brass

Fixture	Height	Depth	Clamp	Shade Material	Bulb	Shade Size	Cord
GP14-81	adjustable 8½" gooseneck	14"	felt-lined, 5½" x 2½"	metal	two 40T10 or 60T10	14"	9' brown
GP14-7	adjustable 8½" gooseneck	14"	felt-lined, 5½" x 2½"	metal	two 40T10 or 60T10	14"	9' black
GP14-61	adjustable 8½" gooseneck	14"	felt-lined, 5½" x 2½"	metal	two 40T10 or 60T10	14"	9' brown

Switch: on/off in-line 3" from clamp
Clamp: adjusts from ½" – ¾"

Specialty Piano Lamps



GPH10-PB
Finish: Polished Brass



GPH10-BLK
Finish: Black

Fixture	Height	Depth	Extension	Clamp	Shade Material	Bulb	Shade Size
GPH10-PB	5½"	10"	8½"	felt-lined, 5½" × 2½"	metal	50W GU10 halogen (included)	10"
GPH10-BLK	5½"	10"	8½"	felt-lined, 5½" × 2½"	metal	50W GU10 halogen (included)	10"

Cord: 10' black
Switch: full range dimmer on shade
Clamp: adjusts from ½" – ¾"

Specialty Piano Lamps



GPLED19-527

Finish: Black with Satin Nickel Accents



GPLED19-61

Finish: Polished Brass



GPLED26-7

Finish: Black



GPLED19-7

Finish: Black with Brass Accents

Fixture	Height	Depth	Extension	Shade Material	Clamp	LED	Shade Size	Switch
GPLED19-61	7½" from top of clamp to top of arm	19"	5"	metal	5½" × 2½" felt-lined	Integrated 3000K, 80 CRI, 4.7 Watts, 200 Lumens	19"	on/off in-line 3" from clamp
GPLED19-527	7½" from top of clamp to top of arm	19"	5"	metal	5½" × 2½" felt-lined	Integrated 3000K, 80 CRI, 4.7 Watts, 200 Lumens	19"	on/off in-line 3" from clamp
GPLED19-7	7½" from top of clamp to top of arm	19"	5"	metal	5½" × 2½" felt-lined	Integrated 3000K, 85 CRI, 4.5 Watts, 500 Lumens	19"	on/off in-line 3" from clamp
GPLED26-7	6¾" from top of clamp to top of arm	26"	5"	metal	5½" × 2½" felt-lined	Integrated 3000K, 85 CRI, 4.5 Watts, 500 Lumens	26"	on/off on shade
Cord: 10' black with plug-in driver Clamp: adjusts up to ¾"								

Specialty Piano Lamps



GPXL-617
Finish: Black with Brass Accents



GPXL22-61
Finish: Polished Brass

Fixture	Height	Depth	Extension	Shade Material	Clamp	Bulb	Shade Size	Cord
GPXL-617	adjustable	22"	8"	metal	felt-lined, 5½" × 2½"	four 15T4 (included)	1" × 22" rotating	10' black
GPXL22-61	adjustable	22"	8"	metal	felt-lined, 5½" × 2½"	four 15T4 (included)	1" × 22" rotating	10' brown
Switch: on/off in-line 3" from clamp Clamp: adjusts from ½" – ¾"								

Specialty Desk/Piano Lamps

Marble is a natural material and therefore, each piece will have variations.

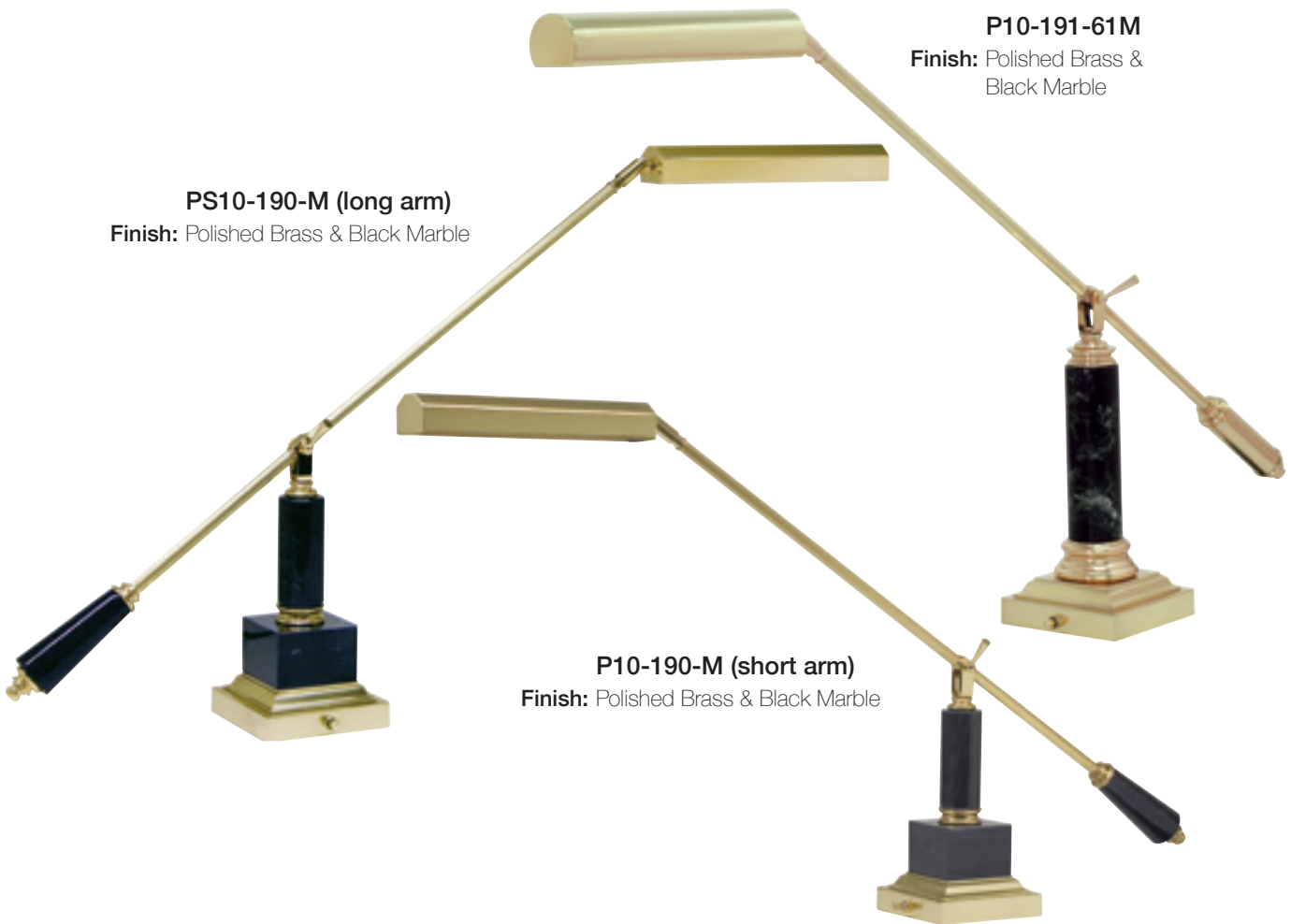
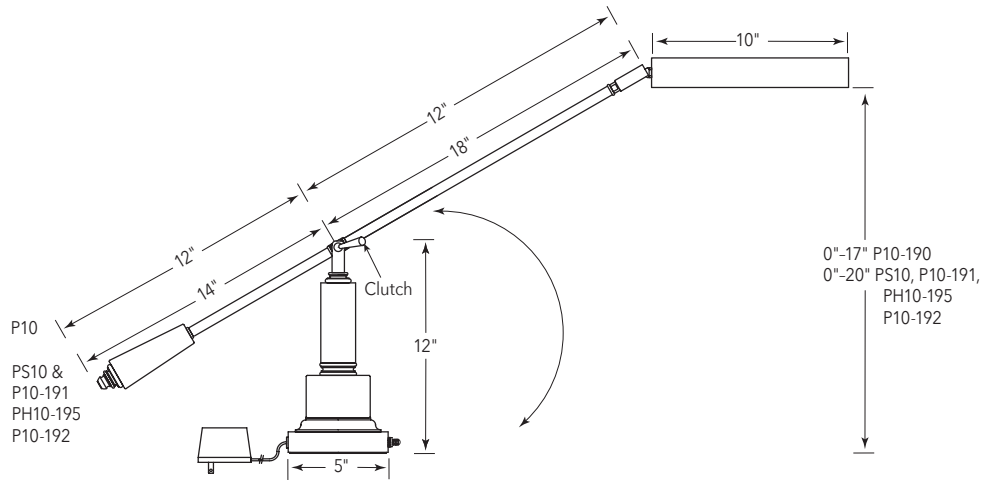

PS10-190-M (long arm)
Finish: Polished Brass & Black Marble

P10-191-61M
Finish: Polished Brass & Black Marble

P10-190-M (short arm)
Finish: Polished Brass & Black Marble

Fixture	Height	Base	Shade Material	Bulb	Shade Size
P10-191-61M	maximum 20"	5"	metal	13W-PL fluorescent	10"
PS10-190-M (long arm)	maximum 20"	5"	metal	13W-PL fluorescent	10"
P10-190-M (short arm)	maximum 17"	5"	metal	13W-PL fluorescent	10"
Cord: 11' black with transformer Switch: on/off on base					

Specialty Desk/Piano Lamps

See drawing on page 325 for lengths.

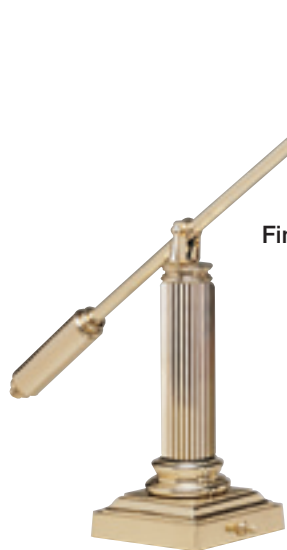

P10-191-61
Finish: Polished Brass



P10-191-81
Finish: Mahogany Bronze



P10-191-71
Finish: Antique Brass

Fixture	Height	Extension	Base	Shade Material	Bulb	Shade Size
P10-191-81	maximum 20"	28"	5"	metal	13W-PL fluorescent	10"
P10-191-61	maximum 20"	28"	5"	metal	13W-PL fluorescent	10"
P10-191-71	maximum 20"	28"	5"	metal	13W-PL fluorescent	10"

Cord: 11' black with transformer
Switch: on/off on base

Specialty Desk/Piano Lamps



Marble is a natural material and therefore, each piece will have variations.

See drawing on page 325 for lengths.

P10-192-617
Finish: Polished Brass & Black



P10-192-627
Finish: Chrome & Black

Fixture	Height	Extension	Base	Shade Material	Bulb	Shade Size
P10-192-627	maximum 20"	28"	6"	metal	one 40T10 or 60T10	10"
P10-192-617	maximum 20"	28"	6"	metal	one 40T10 or 60T10	10"
PLED-192-627	maximum 20"	28"	6"	metal	LED integrated 3000K, 85 CRI, 4,5 watts, 500 lumens	10"
PLED-192-617	maximum 20"	28"	6"	metal	LED integrated 3000K, 85 CRI, 4,5 watts, 500 lumens	10"
Cord: 9' black Switch: on/off on socket						

Specialty Desk/Piano Lamps

See drawing on page 325 for lengths.



PH10-195-PB

Finish: Polished Brass

PH10-195-OB

Finish: Oil Rubbed Bronze

PH10-195-AB

Finish: Antique Brass

Fixture	Height	Extension	Base	Shade Material	Bulb	Shade Size
PH10-195-PB	maximum 20"	28"	6"	metal	50W GU10 Halogen (included)	10"
PH10-195-OB	maximum 20"	28"	6"	metal	50W GU10 Halogen (included)	10"
PH10-195-AB	maximum 20"	28"	6"	metal	50W GU10 Halogen (included)	10"
Cord: 10' brown Switch: full range dimmer on shade						

Floor/Piano Lamps

Incandescent (shown) **PFL-617**
Finish: Black & Polished Brass

LED **PFLED-617**
Finish: Black & Polished Brass

FL10-MB
Finish: Mahogany Bronze

LED (shown)

PFLED-527
Finish: Black & Satin Nickel

Incandescent

PFL-527
Finish: Black & Satin Nickel

Fixture	Height	Extension	Base	Shade Material	LED / Bulb	Shade Size	Switch
PFLED-617	maximum 54"	39½"	10"	metal	Integrated 3000K, 85 CRI, 4.5 Watts, 500 Lumens	12"	on/off on shade
PFL-617	maximum 54"	39½"	10"	metal	one 60T10	10"	on/off on socket
FL10-MB	maximum 54"	41½"	10"	metal	one 60T10	10"	on/off on socket
PFLED-527	maximum 54"	41½"	10"	metal	Integrated 3000K, 85 CRI, 4.5 Watts, 500 Lumens	12"	on/off on shade
PFL-527	maximum 54"	41½"	10"	metal	one 60T10	12"	on/off on socket
Cord: 10' black							

Specialty Task Lamps

Lectern Lights

Designed to be permanently installed on surfaces up to 2" thick.



L10-61
Finish: Polished Brass



Fixture	Height	Width	Shade Material	Bulb	Shade Size
L10-61	7"	1¾" between arms	metal	one 40 or 60T10F	10"
Cord: 10' brown with snap-on plug included Switch: on/off on shade					

Mantel Light



MA14-B

Finishes

-  Antique Brass (AB)
-  Polished Brass (B)
-  Mahogany Bronze (MB)

Fixture	Height	Base	Bulb	Switch	Shade Size
MA14-B	4½"	15" × 3"	two 25 or 40T10F	on/off in-line, 15" from base	14"
MA14-AB	4½"	15" × 3"	two 25 or 40T10F	on/off in-line, 15" from base	14"
MA14-MB	4½"	15" × 3"	two 25 or 40T10F	on/off in-line, 15" from base	14"
Cord: 10' brown, exits back of shade					

Battery Operated LED

Finishes

-  Black #7
-  Antique Brass #71



LABLED7-7
Finish: Black

Fixture	Height	Extension	LED	Switch	Shade Size
LABLED7-7	7¼"	5¼"	3000K, 80 CRI, 1 Watts, 35 Lumens	on/off on shade	7"
LABLED7-71	7¼"	5¼"	3000K, 80 CRI, 1 Watts, 35 Lumens	on/off on shade	7"
Batteries: 4 AA (not included), illuminates 36–48 hours					

Specialty Task Lamps



Cabinet Light

10' brown cord with snap on plug. Cord exits back. On/off switch on shade.

AC7-61



Finishes

-  Polished Brass #61
-  Antique Brass #71

Product Options:

- AC7-61**
- AC7-71**

Bed Light



BL10-AB

- Finish:** Antique Brass
- Height:** Gooseneck Adjusts from 0" to 8½"
- Base:** Adjustable clip Up to 2½" Wide
- Bulb:** One 40T10
- Switch:** on/off on shade
- Shade:** 10"
- Cord:** 10' brown

Portable Spot Lights

Finishes

-  White #9
-  Black #7
-  Satin Nickel #52

SP510-52

- Height:** 6½"
- Cord:** 10' black
- Switch:** on/off 18" from shade
- Bulbs:** 25RIHN (included)

Product Options:

- SP510-7**
- SP510-9**
- SP510-52**



Clip-on Light

Ideal for use with laptop computers, easels, music stands and home office spaces.

Bulb: 25T10 Included

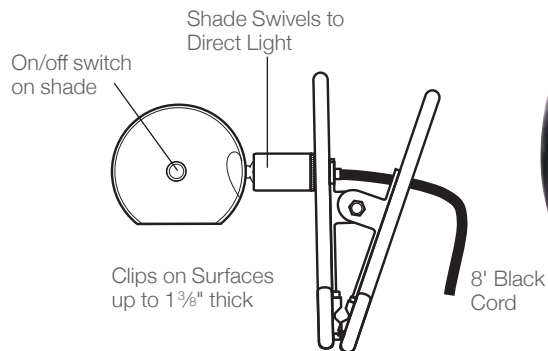

Finish

-  Black #7

ACL7-7



USB Bunk Lamps

Available in Pin Up Only

BUNK2-WT
Finish: White with Natural Oak



BUNK2-BLK
Finish: Black with Stained Oak



BUNK3-BLK
Finish: Black with Stained Oak



BUNK3-WT
Finish: White with Natural Oak

Fixture	Base	Bulb	Switch
BUNK2-BLK	2"H x 10"L x 5½"D with USB port	2700K, 90+CRI, 8W, 800 Lumens	full range dimmer on base
BUNK2-WT	2"H x 10"L x 5½"D with USB port	2700K, 90+CRI, 8W, 800 Lumens	full range dimmer on base
BUNK3-BLK	2"H x 12"L x 5½"D with USB port	one 60W-ST18 (not included)	full range dimmer on base
BUNK3-WT	2"H x 12"L x 5½"D with USB port	one 60W-ST18 (not included)	full range dimmer on base
Cord: 10' clear			

Scatchard Stoneware



George Scatchard came to Vermont in 1960 to set up his first pottery as the back to the land movement in Vermont took hold. This artisan potter taught ceramics at the University of Vermont while continuing to create pottery in his own rural studio.

Scatchard design patterns are created from original hand thrown pieces then slip cast in a mold to improve consistency in shape and size.

Each piece is trimmed, glazed and signed by the potter, then fired at 2300° for 24 hours to create a beautiful and lasting surface.

Scatchard Stoneware



GS50-GG (*Gray Gloss*)

Scatchard Stoneware

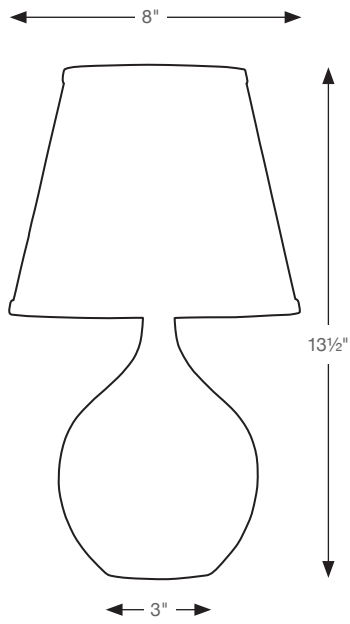

GS50-EG
Glaze Shown: Eggplant

Fixture	Height	Base	Cord	Switch	Bulb	Shade Material	Shade Size	Shade Number
GS50-EG	13 1/2"	3"	10' clear	on/off on socket	75W Type A	fine white linen hardback	6" x 8" x 7"	40218

Available stoneware glazes shown on pages 379-380

Scatchard Stoneware

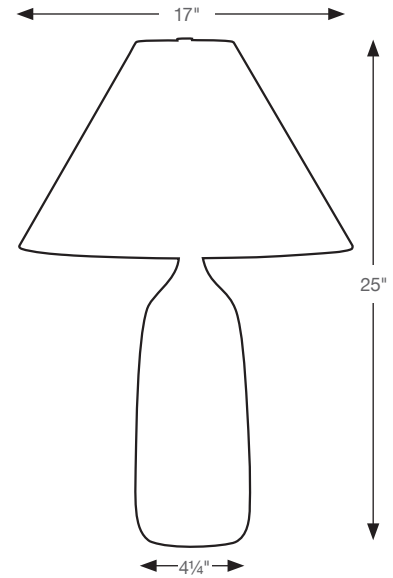

GS100-BR

Glaze Shown: Brown Gloss

Fixture	Height	Base	Cord	Switch	Bulb	Shade Material	Shade Size	Shade Number
GS100-BR	25"	4 1/4"	10' clear	on socket	150W 3-Way	cream linen hardback	5" x 17" x 10 1/2"	40541AB
<i>Available stoneware glazes shown on pages 379-380</i>								

Scatchard Stoneware

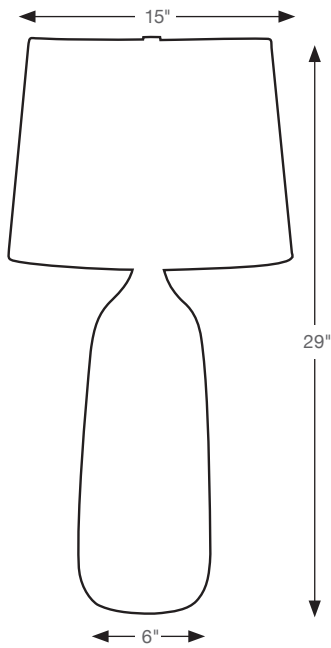

GS101-DCG

Glaze Shown: Decorated Celadon Gloss

Fixture	Height	Base	Cord	Switch	Bulb	Shade Material	Shade Size	Shade Number
GS101-DCG	29"	6"	10' silver	on socket	150W 3-Way	off-white linen hardback	13" x 15" x 11"	40560

Available stoneware glazes shown on pages 379-380

Scatchard Stoneware



GSB105-BG (*Blue Gloss*)

Scatchard Stoneware



GSB105-BM

Glaze: Black Matte with Satin Nickel Accents



GSB105-SD

Glaze: Sand with Antique Brass Accents

Fixture	Height	Base	Cord	Bulb	Shade Material	Shade Size	Shade Number
GSB105-BM	26"	5½" with rocker switch and USB port	10' clear	one 150W type A	white linen hardback	13" x 14" x 9½"	40578N
GSB105-SD	26"	5½" with rocker switch and USB port	10' clear	one 150W type A	off-white linen hardback	13" x 14" x 9½"	40578

Scatchard Stoneware



GS110-GG
Glaze: Gray Gloss



GS110-DWM
Glaze: Decorated White Matte

Fixture	Height	Base	Cord	Switch	Bulb	Shade Material	Shade Size	Shade Number
GS110-GG	26"	6½"	10' clear	on socket	150W 3-way	white linen hardback	14" × 16" × 10½"	40431A
GS110-DWM	26"	6½"	10' clear	on socket	150W 3-way	white linen hardback	14" × 16" × 10½"	40431A

Scatchard Stoneware



Savannah Brown Photography on location at Field Guide, Stowe VT

GS120-BM (*Black Matte*)

Scatchard Stoneware

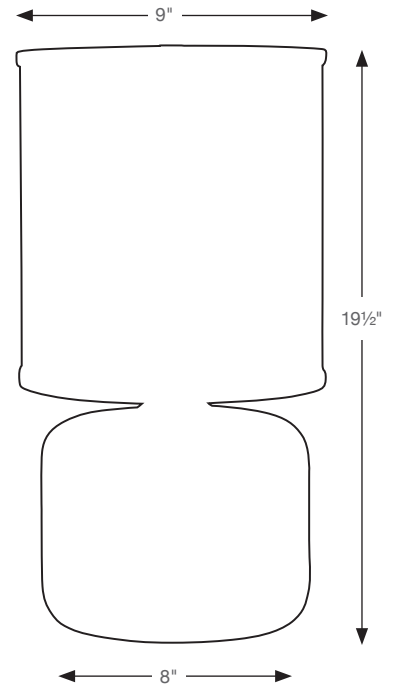

GS120-CR

Glaze Shown: Copper Red

Fixture	Height	Base	Cord	Switch	Bulb	Shade Material	Shade Size	Shade Number
GS120-CR	19½"	8"	10' clear	on/off in-line on cord	100W Type A	off-white linen hardback	9" × 9" × 10"	40543AB

Available stoneware glazes shown on pages 379-380

Scatchard Stoneware

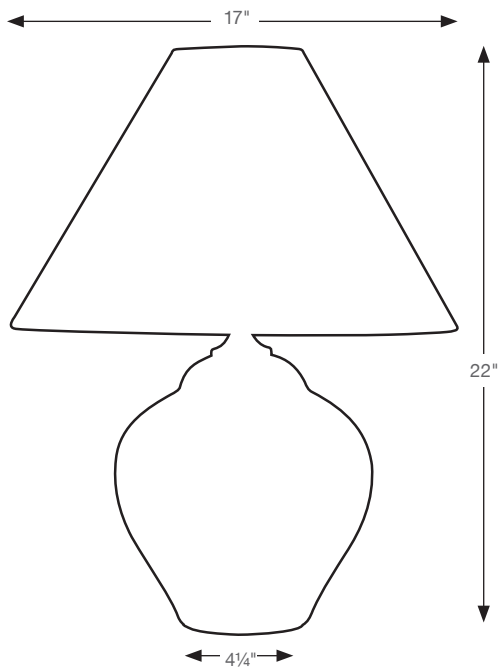

GS130-OT

Glaze Shown: Oatmeal

Fixture	Height	Base	Cord	Switch	Bulb	Shade Material	Shade Size	Shade Number
GS130-OT	22"	4¼"	10' clear	on socket	150W 3-Way	cream linen hardback	5" × 17" × 10½"	40541AB
<i>Available stoneware glazes shown on pages 379-380</i>								

Scatchard Stoneware



GS140-CG (Celadon Gloss)

Scatchard Stoneware

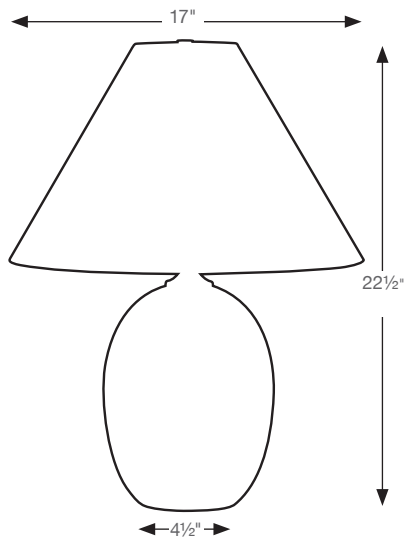

GS140-GM
Glaze Shown: Green Matte

Fixture	Height	Base	Cord	Switch	Bulb	Shade Material	Shade Size	Shade Number
GS140-GM	22 1/2"	4 1/2"	10' clear	on socket	150W 3-Way	cream linen hardback	5" x 17" x 10 1/2"	40541AB

Available stoneware glazes shown on pages 379-380

Scatchard Stoneware

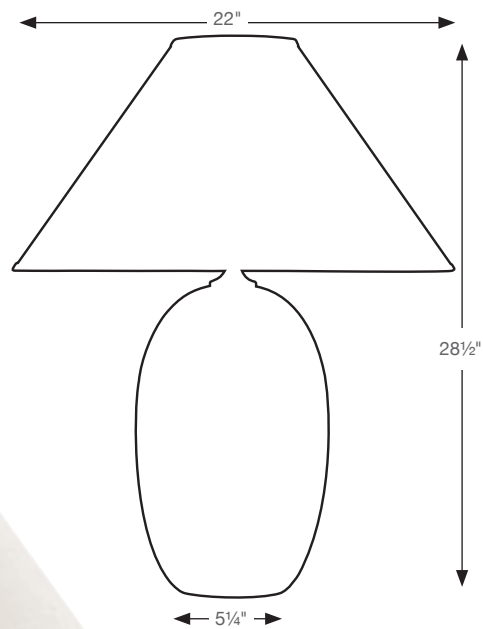

GS150-DWG

Glaze Shown: Decorated White Gloss

Fixture	Height	Base	Cord	Switch	Bulb	Shade Material	Shade Size	Shade Number
GS150-DWG	28½"	5¼"	10' clear	on socket	250W 3-Way	cream linen hardback	6" x 22" x 14"	40548AB
<i>Available stoneware glazes shown on pages 379-380</i>								

Scatchard Stoneware

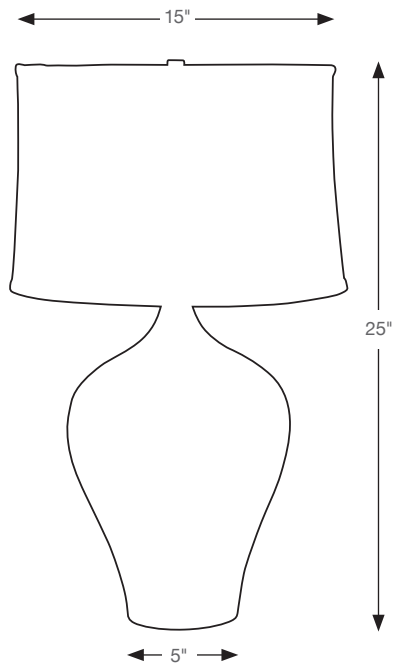

GS160-CB
 Glaze Shown: Cornflower Blue

Fixture	Height	Base	Cord	Switch	Bulb	Shade Material	Shade Size	Shade Number
GS160-CB	25"	5"	10' clear	on socket	150W 3-way	white linen softback	14" x 15" x 10"	40513
<i>Available stoneware glazes shown on pages 379-380</i>								

Scatchard Stoneware

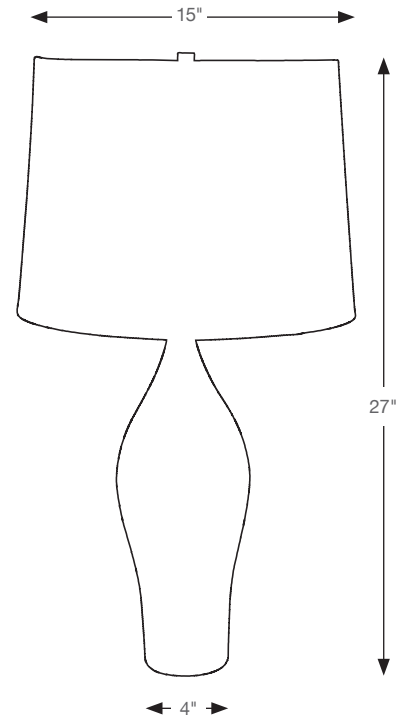

GS170-CR

Glaze Shown: Copper Red

Fixture	Height	Base	Cord	Switch	Bulb	Shade Material	Shade Size	Shade Number
GS170-CR	27"	4"	10' silver	on socket	150W 3-way	off-white linen hardback	13" x 15" x 11"	40560

Available stoneware glazes shown on pages 379-380

Scatchard Stoneware

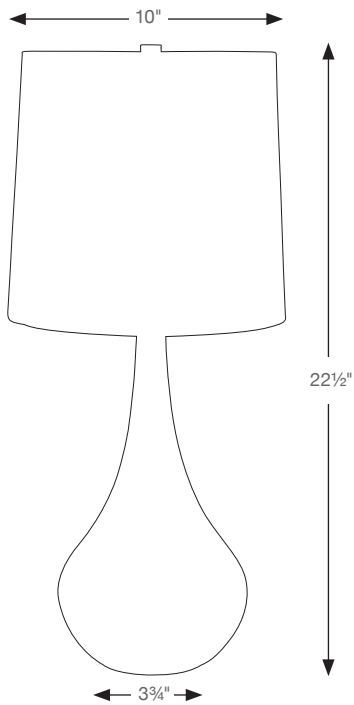

GS180-CG

Glaze Shown: Celadon

Fixture	Height	Base	Cord	Switch	Bulb	Shade Material	Shade Size	Shade Number
GS180-CG	22½"	3¾"	10' clear	on socket	100W 3-Way	off-white linen hardback	9" × 10" × 9½"	40516
<i>Available stoneware glazes shown on pages 379-380</i>								

Scatchard Stoneware

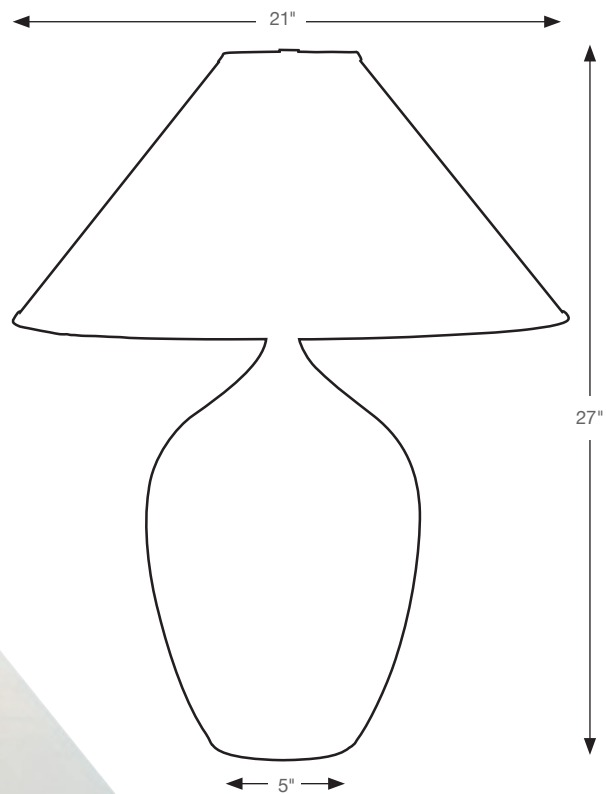

GS190-DR

Glaze Shown: Decorated Red Gloss

Fixture	Height	Base	Cord	Switch	Bulb	Shade Material	Shade Size	Shade Number
GS190-DR	27"	5"	10' clear	on socket	150W 3-Way	cream linen hardback	5" x 21" x 19"	40547
<i>Available stoneware glazes shown on pages 379-380</i>								

Scatchard Stoneware



Savannah Brown Photography on location at Field Guide, Stowe VT

GS200-WM (*White Matte*)

Scatchard Stoneware



GS200-SBR

Finish: Scored Brown Gloss



GS200-SBG

Finish: Scored Blue Gloss

Fixture	Height	Base	Cord	Switch	Bulb	Shade Material	Shade Size	Shade Number
GS200-SBR	19"	3¾"	10' clear	on socket	one 100W 3-way	cream linen hardback	5" × 13" × 10"	40540AB
GS200-SBG	19"	3¾"	10' clear	on socket	one 100W 3-way	cream linen hardback	5" × 13" × 10"	40540SN

Scatchard Stoneware

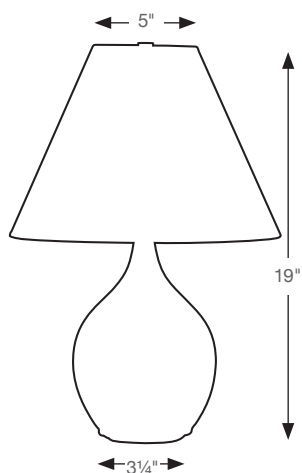

GS200-TE
Glaze Shown: Tiger's Eye

Fixture	Height	Base	Cord	Switch	Bulb	Shade Material	Shade Size	Shade Number
GS200-TE	19"	3 1/4"	10' clear	on socket	100W 3-Way	cream linen hardback	5" x 13" x 10"	40540AB
<i>Available stoneware glazes shown on pages 379-380</i>								

Scatchard Stoneware

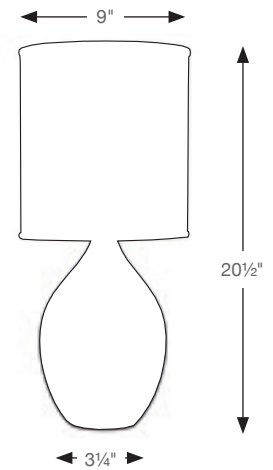

GS201-BG

Glaze Shown: Blue Gloss

Fixture	Height	Base	Cord	Switch	Bulb	Shade Material	Shade Size	Shade Number
GS201-BG	20½"	3¼"	10' clear	on socket	100W 3-Way	white linen hardback	9" × 9" × 10"	40543N

Available stoneware glazes shown on pages 379-380

Scatchard Stoneware

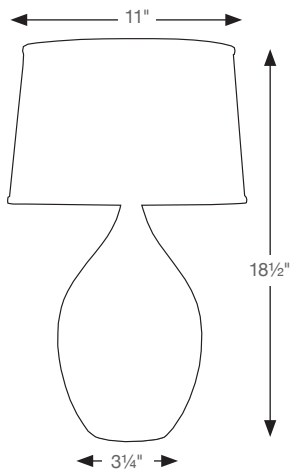

GS202-CR
Glaze Shown: Copper Red

Fixture	Height	Base	Cord	Switch	Bulb	Shade Material	Shade Size	Shade Number
GS202-CR	18½"	3¼"	10' clear	on socket	100W 3-Way	white linen hardback	9" × 11" × 8"	40566AB
<i>Available stoneware glazes shown on pages 379-380</i>								

Scatchard Stoneware

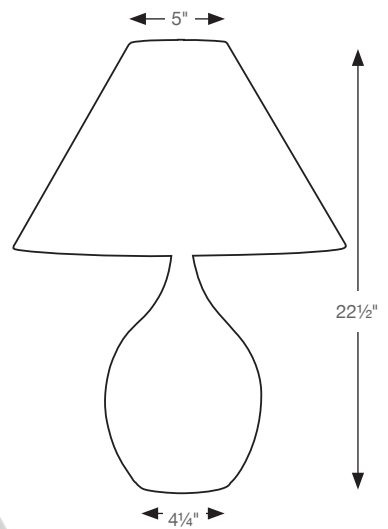

GS300-MID

Glaze Shown: Midnight Blue

Fixture	Height	Base	Cord	Switch	Bulb	Shade Material	Shade Size	Shade Number
GS300-MID	22½"	4¼"	10' clear	on socket	150W 3-Way	cream linen hardback	5" × 17" × 12"	40541N

Available stoneware glazes shown on pages 379-380

Scatchard Stoneware

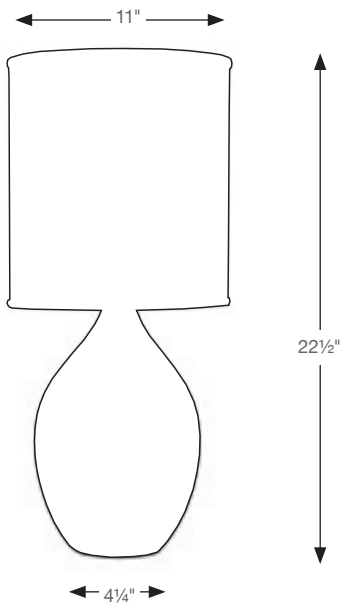

GS301-DG
 Glaze Shown: Decorated Gray

Fixture	Height	Base	Cord	Switch	Bulb	Shade Material	Shade Size	Shade Number
GS301-DG	22½"	4¼"	10' clear	on socket	150W 3-Way	white linen hardback	11" x 11" x 12"	40544N
<i>Available stoneware glazes shown on pages 379-380</i>								

Scatchard Stoneware

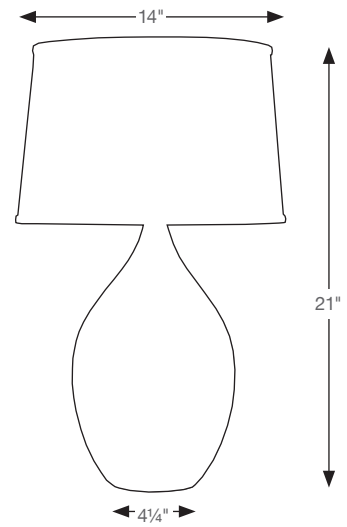

GS302-BM

Glaze Shown: Black Matte

Fixture	Height	Base	Cord	Switch	Bulb	Shade Material	Shade Size	Shade Number
GS302-BM	21"	4 1/4"	10' clear	on socket	150W 3-Way	white linen hardback	12" x 14" x 9"	40567N

Available stoneware glazes shown on pages 379-380

Scatchard Stoneware

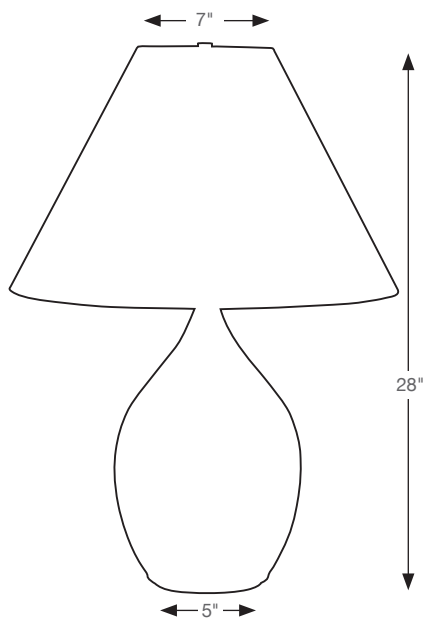

GS400-CG

Glaze Shown: Celadon

Fixture	Height	Base	Cord	Switch	Bulb	Shade Material	Shade Size	Shade Number
GS400-CG	28"	5"	10' clear	on socket	250W 3-Way	cream linen hardback	7" x 20" x 14"	40542AB
<i>Available stoneware glazes shown on pages 379-380</i>								

Scatchard Stoneware

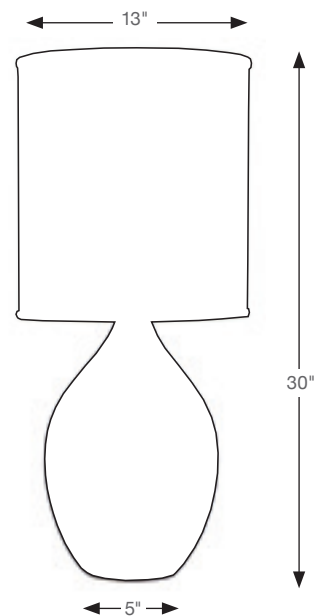

GS401-GG

Glaze Shown: Gray Gloss

Fixture	Height	Base	Cord	Switch	Bulb	Shade Material	Shade Size	Shade Number
GS401-GG	30"	5"	10' clear	on socket	200W 3-Way	white linen hardback	13" x 13" x 14"	40549N
<i>Available stoneware glazes shown on pages 379-380</i>								

Scatchard Stoneware



Savannah Brown Photography on location at Field Guide, Stowe VT

GS402-CR (*Copper Red*)

Scatchard Stoneware

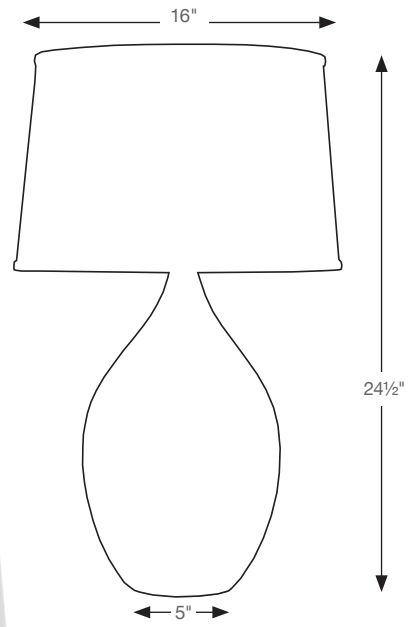

GS402-WM

Glaze Shown: White Matte

Fixture	Height	Base	Cord	Switch	Bulb	Shade Material	Shade Size	Shade Number
GS402-WM	24½"	5"	10' clear	on socket	200W 3-Way	white linen hardback	14" × 16" × 10"	40568N

Available stoneware glazes shown on pages 379-380

Scatchard Stoneware

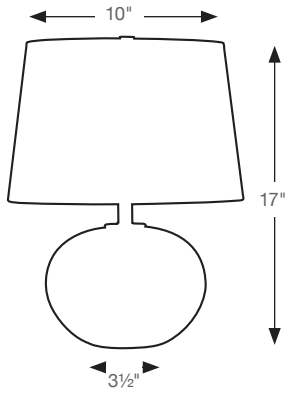

GS600-BM
Glaze Shown: Black Matte

Fixture	Height	Base	Cord	Switch	Bulb	Shade Material	Shade Size	Shade Number
GS600-BM	17"	3 1/2"	10' clear	on/off on socket	100W Type A	white linen hardback	10" x 12" x 8"	40563
<i>Available stoneware glazes shown on pages 379-380</i>								

Scatchard Stoneware



Savannah Brown Photography on location at Field Guide, Stowe VT

GS700-BM (*Black Matte*)

Scatchard Stoneware

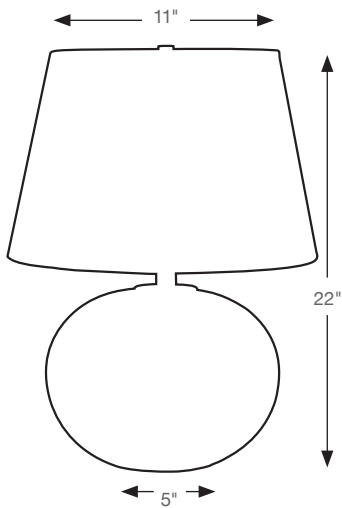

GS700-BG
 Glaze Shown: Blue Gloss

Fixture	Height	Base	Cord	Switch	Bulb	Shade Material	Shade Size	Shade Number
GS700-BG	22"	5"	10' clear	on socket	150W 3-Way	white linen hardback	11" x 15" x 10"	40564

Available stoneware glazes shown on pages 379-380

Scatchard Stoneware

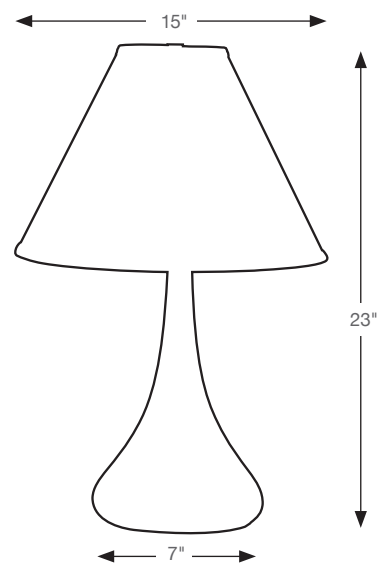

GS800-BM

Glaze Shown: Black Matte

Fixture	Height	Base	Cord	Switch	Bulb	Shade Material	Shade Size	Shade Number
GS800-BM	23"	7"	10' clear	on socket	100W 3-Way	off-white linen hardback	5" x 15" x 11"	40545N

Available stoneware glazes shown on pages 379-380

Scatchard Stoneware

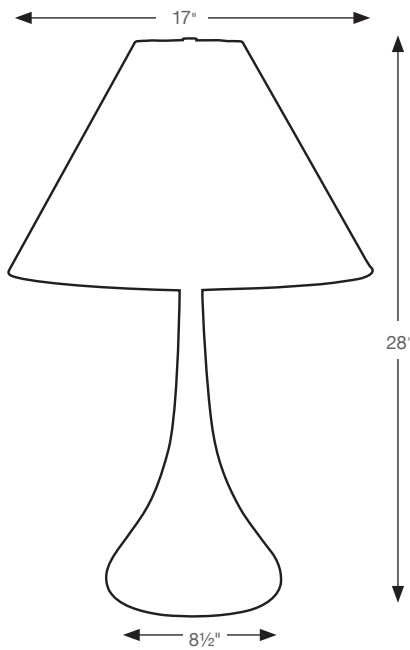

GS801-IR
Glaze Shown: Iron Red

Fixture	Height	Base	Cord	Switch	Bulb	Shade Material	Shade Size	Shade Number
GS801-IR	28"	8 1/2"	10' clear	on socket	100W 3-way	cream linen hardback	5" x 17" x 10 1/2"	40541AB
<i>Available stoneware glazes shown on pages 379-380</i>								

Scatchard Stoneware

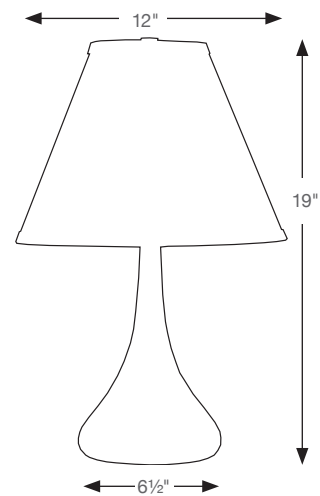

GS802-BM

Glaze Shown: Black Matte

Fixture	Height	Base	Cord	Switch	Bulb	Shade Material	Shade Size	Shade Number
GS802-BM	19"	6½"	10' clear	on/off on socket	100W Type A	off-white linen hardback	5" × 12" × 9½"	40538
<i>Available stoneware glazes shown on pages 379-380</i>								

Scatchard Stoneware



GS850-KS (*Kaleidoscope*)

Scatchard Stoneware



GS850-WG
Glaze Shown: White Gloss

Fixture	Height	Base	Cord	Switch	Bulb	Shade Material	Shade Size	Shade Number
GS850-WG	25½"	6"	10' clear	on socket	100W 3-way	off-white linen hardback	10" × 13" × 11"	40412N
<i>Available stoneware glazes shown on pages 379-380</i>								

Scatchard Stoneware



GS725-BG
Finish: Blue Gloss with
Satin Nickel



GS725-BR
Finish: Brown Gloss with Antique Brass



GS725-OT
Finish: Oatmeal with Oil
Rubbed Bronze



GS725-GM
Finish: Green Matte
with Antique Brass

Fixture	Height	Extension	Backplate	Switch	Bulb	Shade Material	Shade Size	Shade Number
GS725-BG	13½"	12½"	6"	on socket	100W 3-way	cream linen hardback	8" × 9" × 8"	40539
GS725-BR	13½"	12½"	6"	on socket	100W 3-way	natural linen hardback	8" × 9" × 8"	40539C
GS725-OT	13½"	12½"	6"	on socket	100W 3-way	natural linen hardback	8" × 9" × 8"	40539C
GS725-GM	13½"	12½"	6"	on socket	100W 3-way	cream linen hardback	8" × 9" × 8"	40539
Cord: 10' clear with 30" cord cover included (can be direct wired)								
Available stoneware glazes shown on pages 379-380								

Scatchard Stoneware

Direct Wire Only



Fixture	Height	Extension	Backplate	Bulb	Shade Material	Shade Size	Shade Number
GS775-SNBG	14½"	7¾"	6"	one 60WB10	cream linen hardback	4½" × 4½" × 6"	40214C
GS775-SNGG	14½"	7¾"	6"	one 60WB10	cream linen hardback	4½" × 4½" × 6"	40214C
GS775-ABOT	14½"	7¾"	6"	one 60WB10	cream linen hardback	4½" × 4½" × 6"	40214C
GS775-SNBM	14½"	7¾"	6"	one 60WB10	cream linen hardback	4½" × 4½" × 6"	40214C

Available stoneware glazes shown on pages 379-380

Scatchard Stoneware

Direct Wire Only



GS775-2-ABOT
Finish: Antique Brass with Oatmeal



GS775-2-SNBM
Finish: Satin Nickel with Black Matte



GS775-2-SNBG
Finish: Satin Nickel with Blue Gloss



GS775-2-SNGG
Finish: Satin Nickel with Gray Gloss

Fixture	Height	Extension	Backplate	Bulb	Shade Material	Shade Size	Shade Number
GS775-2-ABOT	14½"	7¾"	6"	two 60WB10	cream linen hardback	4½" × 4½" × 6"	40214C
GS775-2-SNBM	14½"	7¾"	6"	two 60WB10	cream linen hardback	4½" × 4½" × 6"	40214C
GS775-2-SNBG	14½"	7¾"	6"	two 60WB10	cream linen hardback	4½" × 4½" × 6"	40214C
GS775-2-SNGG	14½"	7¾"	6"	two 60WB10	cream linen hardback	4½" × 4½" × 6"	40214C

Available stoneware glazes shown on pages 379-380

Custom Direct Mount Lighting

Customizing House of Troy Picture Lights.

We are often asked for custom versions of existing products, especially picture lights. Picture Lights are easily adapted to lighting book cases and display areas.

Picture Lights are easily adapted to lighting book cases and display areas. We have developed hardware to mount through any hard surface. These products are designed as cord and plug items and will require a receptacle to plug them into behind the soffit.

Call our Customer Service department at 800-428-5367 for assistance in designing your direct mount product.



CD-T24-81



CD-SL16-51

Illuminate bookshelves with our Slim-Line Library Lighting. The slim lamp profile is designed for interiors where reduced lamp visibility is desired.

Slim-Line™ Styles

Mounting Options

Arm Styles

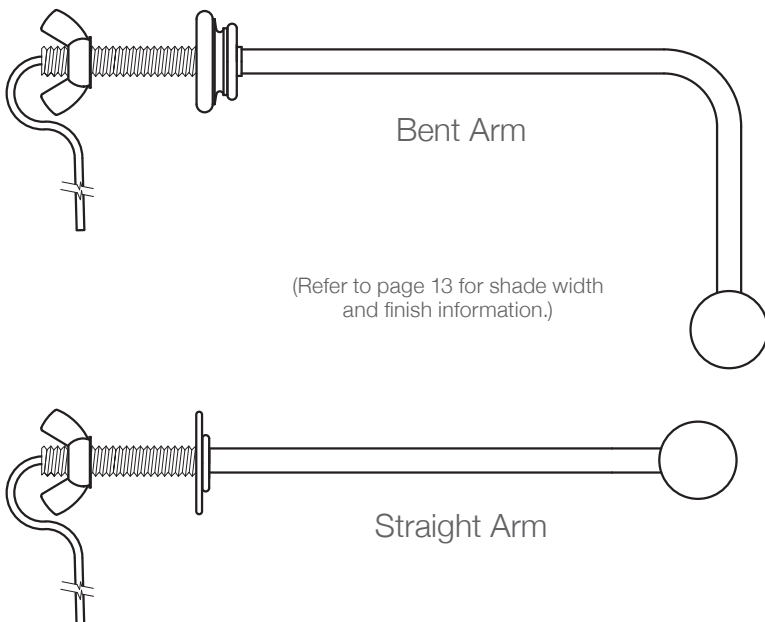



CD-DL10-OB

Classic style lamps are an effective way to enhance traditional décor in either a residential or commercial setting.



CD-HP16-76

Classic Styles

Mounting Options

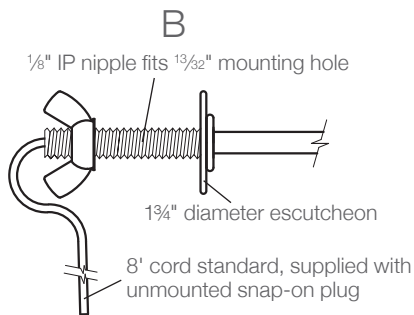
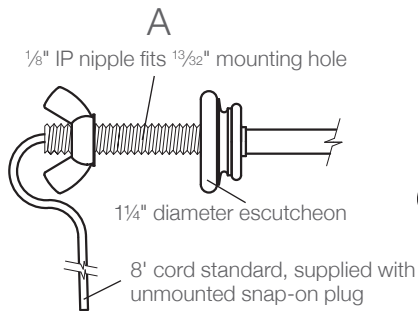

Arm & Shade Styles



Traditional Shade
(Refer to page 17 for shade width and finish options.)



Contemporary Shade
(Refer to page 9 for shade width and finish options.)

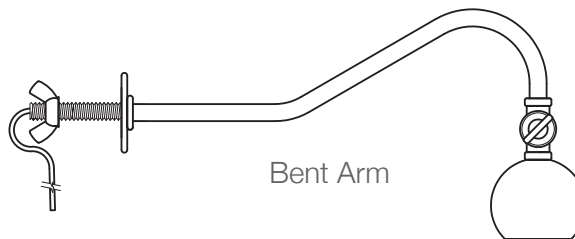

HP Shade
(Refer to page 10 for shade width and finish options.)

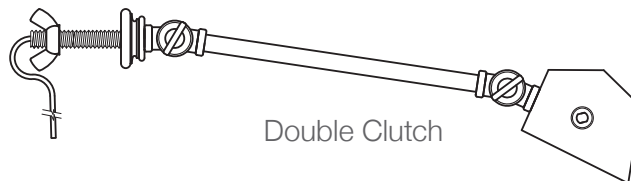

DL Shade
(Refer to page 36 for shade width and finish options.)

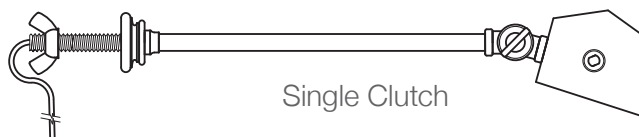

Custom Traditional Picture Lights Made to Order

Accent options available in 8", 14", 24", & 36" lengths

8" – one 25 or 40T10F bulb
 14" – two 25 or 40T10F bulbs
 24" – three 25 or 40T10F bulbs
 36" – five 25 or 40T10F bulbs

When ordering – note T then the style letter from the front of the shade followed by the shade length and then the finish code.

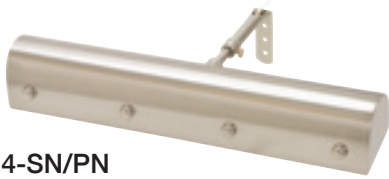

TB14-SN/PN

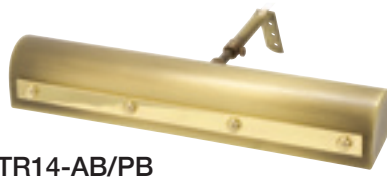

TR14-AB/PB

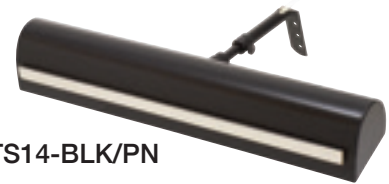

TS14-BLK/PN

Accent Finish Combinations



Antique Brass and Polished Brass
 AB/PB



Black and Polished Nickel
 BLK/PN

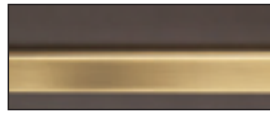

Mahogany Bronze and Antique Brass
 MB/AB



Satin Nickel and Polished Nickel
 SN/PN

Custom Direct Wire Traditional LED Picture Lights Made to Order

Available in:

14" shade
 2700k, 90+CRI, 4.5 watt,
 360 lumen LED
 Backplate: 4½" x 4½"

24" shade
 2700k, 90+CRI, 9 watt,
 720 lumen LED
 Backplate: 4" x 15"

36" shade
 2700k, 90+CRI, 13.5 watt,
 1080 lumen LED
 Backplate: 4" x 15"

When ordering – note DT then the style letter from the front of the shade, then LEDZ followed by the shade length and then the finish code.

Accent options available in 14", 24", & 36" lengths



DTBLEDZ14-MB/AB



DTRLEDZ14-SN/PN

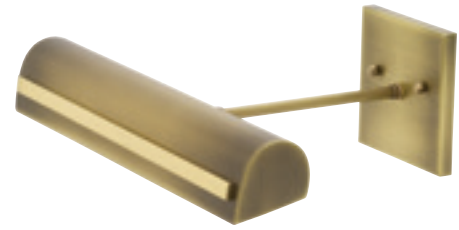

DTSLEDZ14-AB/PB

Accent Finish Combinations

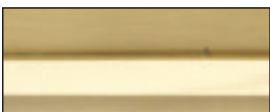

Antique Brass and Polished Brass
 AB/PB

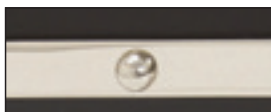

Black and Polished Nickel
 BLK/SN

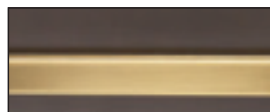

Mahogany Bronze and Antique Brass
 MB/AB

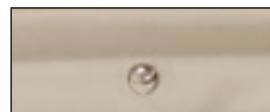

Satin Nickel and Polished Nickel
 SN/PN

Product Finishes

Please refer to this section for color representations of finish. Stocked finishes are listed on specific product pages. If you would like a finish on a Vermont made product that is not stocked, call our customer service department for lead time and cost.

Metal Finishes



Gold #1



Polished Brass #61



Bronze #5



Chrome #62



Pewter #31

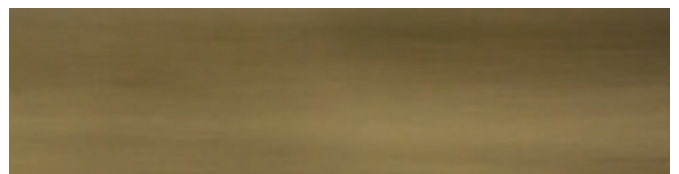

Antique Brass #71



Satin Brass #51



Weathered Brass #76

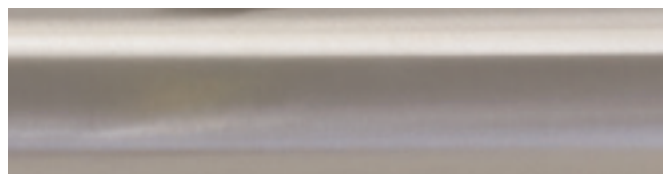

Satin Nickel #52



Mahogany Bronze #81



Statuary Bronze #56

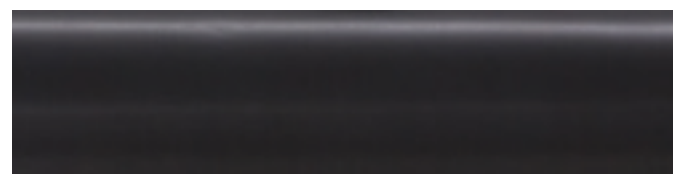

Oil Rubbed Bronze #91



Polished Nickel (PN)

Product Finishes

Powder Coated Finishes



Black #7 (BLK)

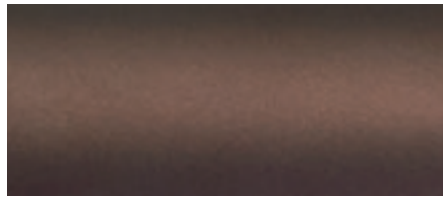

Chestnut Bronze (CHB)

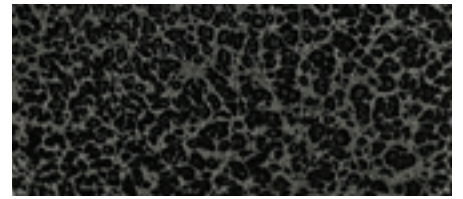

Silver Supreme (SS)



White #9 (WT)

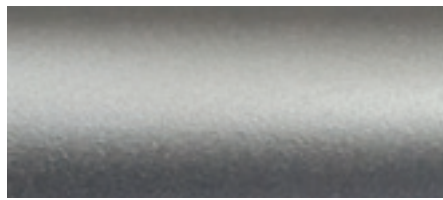

Granite (GT)



Hammered Bronze (HB)

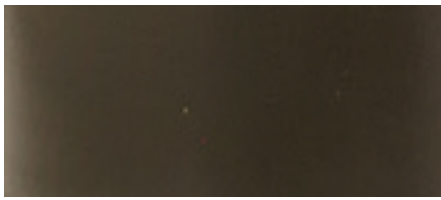

Architectural Bronze (ABZ)



Bittersweet (BS)



Cobalt (CO)



Navy Blue (NB)

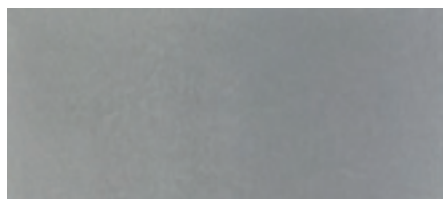

Platinum Gray (PG)



Azure (AZ)

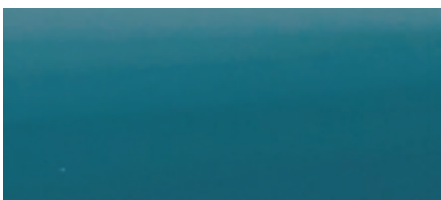

Teal (TL)

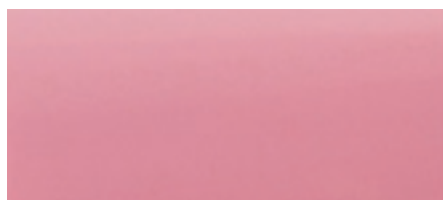

Pink (PK)



Orchid (OR)

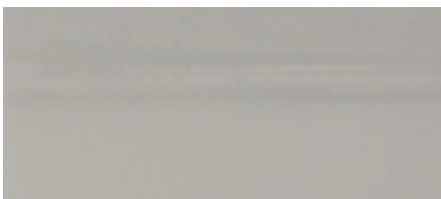

Grey (GR)

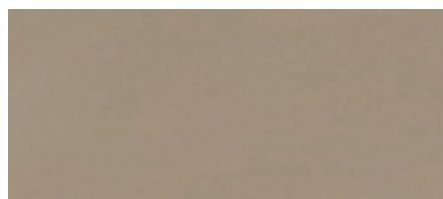

Champagne (CT)



Mint (MT)

Distributed Product Finishes

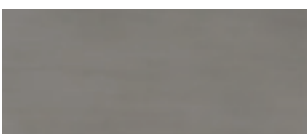

Satin Pewter (SP)

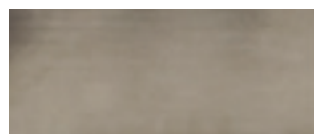

Antique Silver (AS)

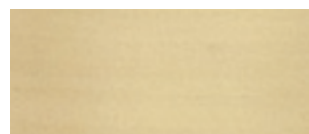

Raw Brass (RB)



Brushed Brass (BB)

Scatchard Stoneware Glazes

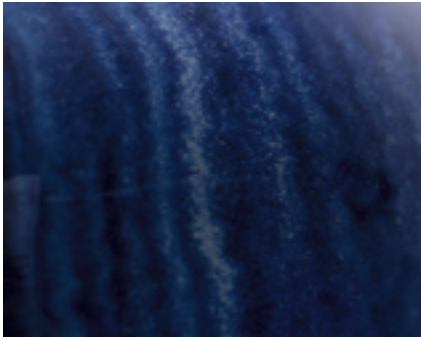

BG Blue Gloss



BM Black Matte

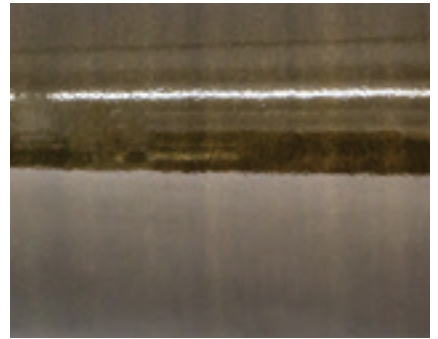

BR Brown Gloss



CB Cornflower Blue



CG Celadon

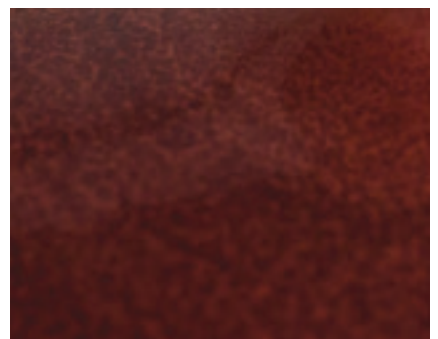

CR Copper Red



DCG Decorated Celadon



DG Decorated Gray

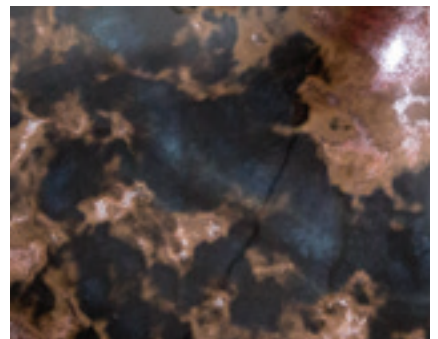

DR Decorated Red

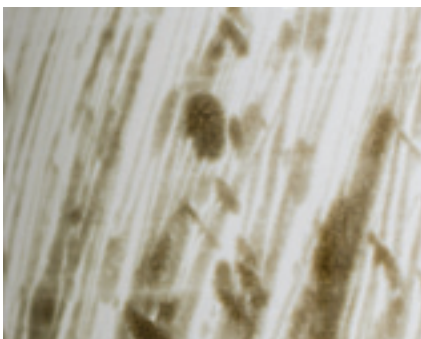

DWG Decorated White Gloss

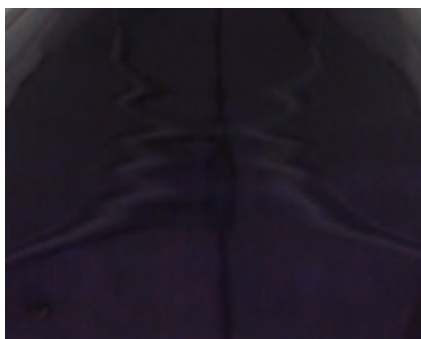

EG Eggplant



GG Gray Gloss

Scatchard Stoneware Glazes

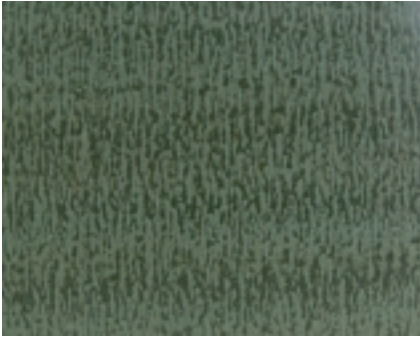

GM Green Matt

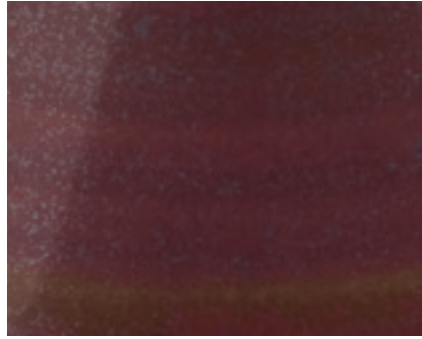

IR Iron Red

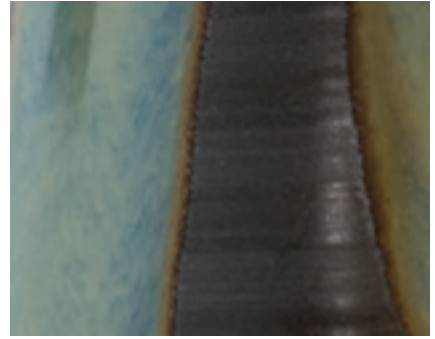

KS Kaleidoscope



MID Midnight Blue

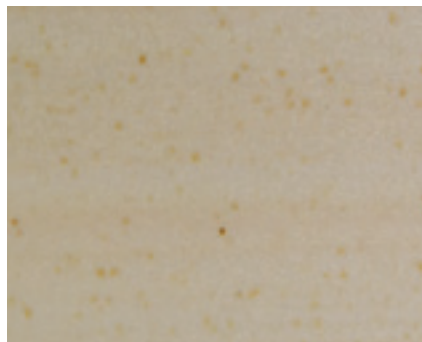

OT Oatmeal



SD Sand

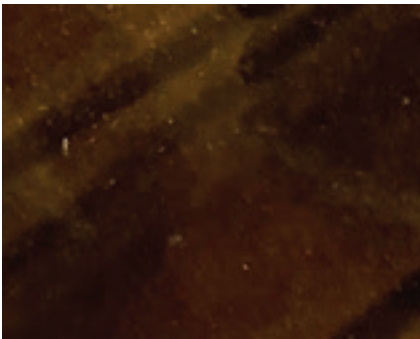

SBR Scored Brown



SBG Scored Blue Gloss

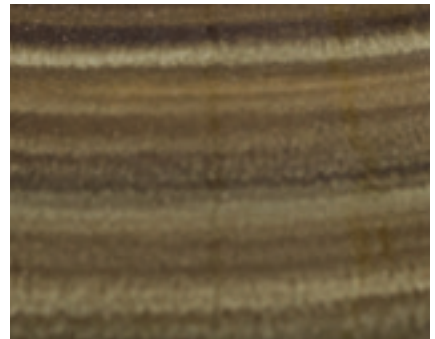

TE Tiger's Eye



WG White Gloss

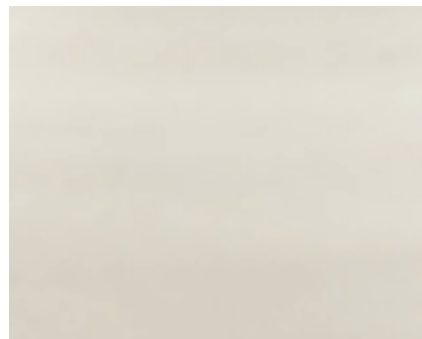

WM White Matte

Questions & Answers

The following are answers to some of the most frequently asked questions about our products which should assist with your selection process.

Q. How do you measure the extension of a swing arm?

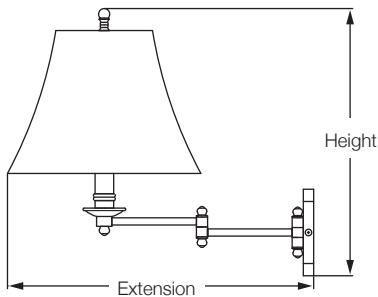

Q. How are lamp shades dimensioned in the catalog?

A. Top x Bottom x Side (slant).

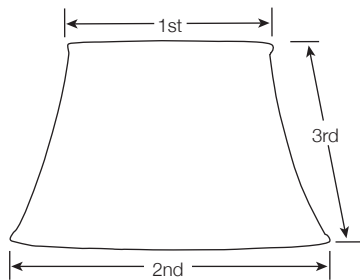

Q. How do you measure the height of a Desk/Piano Lamp?

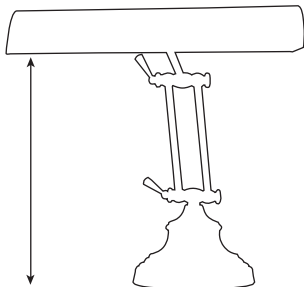

Q. What size picture light should I use?

A. Measure the width of the image and use a Classic picture light approximately one half the size, or a Slim-Line picture light approximately two thirds the size of the image.

Q. Can I modify a cord length and add a polarized plug?

A. Yes. We offer a UL approved snap-on-plug that can be attached to any standard UL approved SPT-2 cord. Instructions are included with plug.

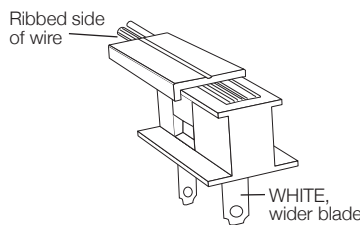

Q. Is there a way to eliminate seeing the cord?

- Install a recessed outlet (sometimes called a "clock outlet") behind the artwork.

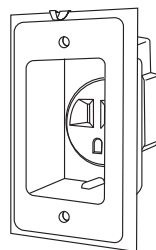

- Use a Cord Cover.
- Paint the cord to match the wall color.
- Place furniture, plants or other décor to hide cord.

Q. How do you install a traditional style picture light?

A. All House of Troy picture lights come with mounting hardware and may be attached to either the picture frame or the wall. The only tools necessary are a screw driver and something to start a screw-hole, such as a small nail or awl. (Bracket size 2½" x 3")

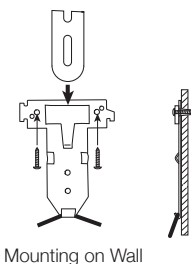
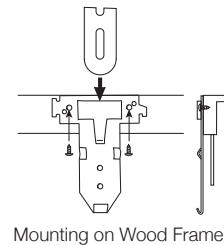

Q. How do you install a Slim-Line Picture Light?

A. Snap the Picture Light arms into the Mounting Brackets. This will take a bit of force, but will not damage the arms. Slide the arms up or down to attain the desired shade location in relation to the frame. (Bracket size 1½" x 2¼")

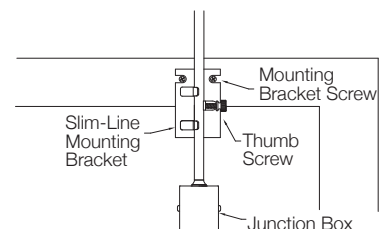

Index

ITEM	PAGE	ITEM	PAGE	ITEM	PAGE	ITEM	PAGE
A7-61*	6	APL16-71	19	BTLED24-51*	76	CH825-AS	114
A7-71*	6	APR16-52	7	BTLED24-61*	76	CH825-OB	114
A14-61*	6	APR16-61	7	BTLED24-71*	76	CH850-AB	115
A14-71*	6	APR16-7	7	BTLED24-81*	76	CH850-OB	115
A700-AB/BLK*	83	APR16-71	7	BUNK2-BLK*	332	CH875-OB	116
A700-BLK/SN*	83	AR401-BLK/SN*	89	BUNK2-WT*	332	CH876-AB	116
A701-AB/HB*	84	AR401-NB/SB*	89	BUNK3-BLK*	332	CH878-AB	116
A701-BLK/SS*	84	AR401-WT/SB*	89	BUNK3-WT*	332	CH880-OB	116
A702-AB/BLK*	85	AR402-BLK/SN*	91	C5-1*	9	CL200-AB	106
A702-BLK/SN*	85	AR403-BLK/SN*	90	C5-51*	9	CL200-AS	106
A750-AB/BLK*	83	AR403-NB/SB*	90	C5-52*	9	CL200-OB	106
A750-BLK/SN*	83	AR403-WT/SB*	90	C5-61*	9	CL201-AB	107
A751-AB/HB*	84	AR404-WB/BLK*	91	C5-62*	9	CL201-AS	107
A751-BLK/SS*	84	AV100-OB*	93	C9-1*	9	CL201-BLK	107
A752-AB/BLK*	85	AV101-OB*	93	C9-1-CA*	9	CL201-OB	107
A752-BLK/SN*	85	B201-SN*	100	C9-51*	9	CL202-AB	108
ABLED7-61*	73	B202-AB*	100	C9-51-CA*	9	CL202-OB	108
ABLED7-71*	73	B203-BLK/SN*	100	C9-52*	9	CL225-AB	109
ABLED14-61*	73	B204-SN*	101	C9-52-CA*	9	CL225-OB	109
ABLED14-71*	73	B205-SB*	101	C9-61*	9	CL250-AB	110
AC7-61*	331	B206-SB*	101	C9-61-CA*	9	CL250-AS	110
AC7-71*	331	B207-BLK/SB*	100	C9-62*	9	CL250-OB	110
ACL7-7*	331	B208-SB/NB*	100	C9-62-CA*	9	CL251-AB	111
AD400-AB	79	B209-SN/BLK*	101	C16-1*	9	CL251-AS	111
AD400-OB	79	B210-BLK/AB*	101	C16-1-CA*	9	CR700-AB	118
AD425-AB	80	BA700-CHB*	95	C16-51*	9	CR700-OB	118
AD425-OB	80	BA701-CHB*	95	C16-51-CA*	9	CR725-AB	119
AD450-AB	81	BA750-CHB*	95	C16-52*	9	CR725-OB	119
AD450-OB	81	BL10-AB	331	C16-52-CA*	9	CR725-SN	119
AGLED-52	18	BR102-OB	97	C16-61*	9	D100-AB*	121
AGLED-71	18	BR102-SN	97	C16-61-CA*	9	D100-OB*	121
AN600-AB	87	BR150-OB	98	C16-62*	9	D100-SN*	121
AP10-20-61	300	BR150-SN	98	C16-62-CA*	9	D150-AB*	122
AP10-20-7	300	BSLED12-51*	74	C24-1*	9	D150-OB*	122
AP10-20-71	300	BSLED12-52*	74	C24-51*	9	D150-SN*	122
AP10-21-61	301	BSLED12-71*	74	C24-52*	9	D175-AB*	123
AP10-21-7	301	BSLED12-91*	74	C24-61*	9	D175-OB*	123
AP10-21-71	301	BSLED24-51*	74	C24-62*	9	D175-SN*	123
AP10-21-91	301	BSLED24-52*	74	C300-WB/BLK*	103	DA14-51*	32
AP10-25-7*	300	BSLED24-71*	74	C300-WB/WT*	103	DA14-52*	32
AP14-40-7	302	BSLED24-91*	74	C350-WB/BLK*	104	DA14-7*	32
AP14-41-7	302	BTLED14-1*	76	C350-WB/WT*	104	DA14-71*	32
AP14-41-71	302	BTLED14-51*	76	CBLED12-61	319	DA24-51*	32
AP14-41-91	303	BTLED14-61*	76	CBLED12-7	319	DA24-52*	32
AP14-45-7*	303	BTLED14-71*	76	CH800-AB	113	DA24-7*	32
APL16-52	19	BTLED14-81*	76	CH800-OB	113	DA24-71*	32
APL16-7	19	BTLED24-1*	76	CH825-AB	114	DALEDZ14-BLKPB*	31

ITEM	PAGE	ITEM	PAGE	ITEM	PAGE	ITEM	PAGE
DALEDZ14-ABMB*	31	DHA05-WT*	53	DOXLEDZ42-SN*	61	DSTLEDZ30-MBAB*	67
DALEDZ14-BLKS*	31	DHLEDZ12-51*	55	DSCLEDZ19-51*	270	DSTLEDZ30-SNBLK*	67
DC9-51*	35	DHLEDZ12-52*	55	DSCLEDZ19-52*	270	DSTLEDZ42-ABMB*	67
DC9-52*	35	DHLEDZ12-62*	55	DSCLEDZ19-61*	270	DSTLEDZ42-MBAB*	67
DC9-61*	35	DHLEDZ12-71*	55	DSCLEDZ19-71*	270	DSTLEDZ42-SNBLK*	67
DC9-62*	35	DHLEDZ12-91*	55	DSCLEDZ19-91*	270	DT8-51*	45
DC16-51*	35	DHLEDZ26-51*	55	DSK428-G61*	313	DT8-52*	45
DC16-52*	35	DHLEDZ26-52*	55	DSK428-G71*	313	DT8-61*	45
DC16-61*	35	DHLEDZ26-62*	55	DSK430-MB*	313	DT8-71*	45
DC16-62*	35	DHLEDZ26-71*	55	DSK500-BLKPN*	313	DT8-81*	45
DC24-51*	35	DHLEDZ26-91*	55	DSL14-51*	41	DT14-51*	45
DC24-52*	35	DL10-OB*	36	DSL14-52*	41	DT14-52*	45
DC24-61*	35	DL10-WB*	36	DSL14-71*	41	DT14-61*	45
DC24-62*	35	DL20-OB*	281	DSL14-91*	41	DT14-71*	45
DCH16-51*	33	DL20-WB*	281	DSL24-51*	41	DT14-81*	45
DCH16-52*	33	DMLLEDZ15-51*	59	DSL24-52*	41	DT24-51*	45
DCH16-7*	33	DMLLEDZ15-52*	59	DSL24-71*	41	DT24-52*	45
DCH16-71*	33	DMLLEDZ15-62*	59	DSL24-91*	41	DT24-61*	45
DCH25-51*	33	DMLLEDZ15-71*	59	DSL36-51*	41	DT24-71*	45
DCH25-52*	33	DMLLEDZ15-91*	59	DSL36-52*	41	DT24-81*	45
DCH25-7*	33	DMLLEDZ29-51*	59	DSL36-71*	41	DT36-51*	45
DCH25-71*	33	DMLLEDZ29-52*	59	DSL36-91*	41	DT36-52*	45
DCLEDZ12-51*	49	DMLLEDZ29-62*	59	DSLEDZ14-51*	63	DT36-61*	45
DCLEDZ12-52*	49	DMLLEDZ29-71*	59	DSLEDZ14-52*	63	DT36-71*	45
DCLEDZ12-71*	49	DMLLEDZ29-91*	59	DSLEDZ14-71*	63	DT36-81*	45
DCLEDZ24-51*	49	DMLLEDZ43-51*	59	DSLEDZ14-91*	63	DTBLEDZ14-AB/PB*	376
DCLEDZ24-52*	49	DMLLEDZ43-52*	59	DSLEDZ28-51*	63	DTBLEDZ14-BLK/PN*	376
DCLEDZ24-71*	49	DMLLEDZ43-62*	59	DSLEDZ28-52*	63	DTBLEDZ14-MB/AB*	376
DGLEDZ14-AB*	51	DMLLEDZ43-71*	59	DSLEDZ28-71*	63	DTBLEDZ14-SN/PN*	376
DGLEDZ14-OB*	51	DMLLEDZ43-91*	59	DSLEDZ28-91*	63	DTBLEDZ24-AB/PB*	376
DGLEDZ14-PN*	51	DOX16-AB*	39	DSLEDZ43-51*	63	DTBLEDZ24-BLK/PN*	376
DGLEDZ14-SN*	51	DOX16-OB*	39	DSLEDZ43-52*	63	DTBLEDZ24-MB/AB*	376
DGLEDZ14-WB*	51	DOX16-SN*	39	DSLEDZ43-71*	63	DTBLEDZ24-SN/PN*	376
DGLEDZ24-AB*	51	DOX30-AB*	39	DSLEDZ43-91*	63	DTBLEDZ36-AB/PB*	376
DGLEDZ24-OB*	51	DOX30-OB*	39	DST16-ABMB*	43	DTBLEDZ36-BLK/PN*	376
DGLEDZ24-PN*	51	DOX30-SN*	39	DST16-MBAB*	43	DTBLEDZ36-MB/AB*	376
DGLEDZ24-SN*	51	DOX42-AB*	39	DST16-SNBLK*	43	DTBLEDZ36-SN/PN*	376
DGLEDZ24-WB*	51	DOX42-OB*	39	DST30-ABMB*	43	DTLEDZ14-51*	69
DGLEDZ36-AB*	51	DOX42-SN*	39	DST30-MBAB*	43	DTLEDZ14-52*	69
DGLEDZ36-OB*	51	DOXLEDZ16-AB*	61	DST30-SNBLK*	43	DTLEDZ14-61*	69
DGLEDZ36-PN*	51	DOXLEDZ16-OB*	61	DST42-ABMB*	43	DTLEDZ14-71*	69
DGLEDZ36-SN*	51	DOXLEDZ16-SN*	61	DST42-MBAB*	43	DTLEDZ14-81*	69
DGLEDZ36-WB*	51	DOXLEDZ30-AB*	61	DST42-SNBLK*	43	DTLEDZ24-51*	69
DHA05-AB*	53	DOXLEDZ30-OB*	61	DSTLEDZ16-ABMB*	67	DTLEDZ24-52*	69
DHA05-BLK*	53	DOXLEDZ30-SN*	61	DSTLEDZ16-MBAB*	67	DTLEDZ24-61*	69
DHA05-MB*	53	DOXLEDZ42-AB*	61	DSTLEDZ16-SNBLK*	67	DTLEDZ24-71*	69
DHA05-SN*	53	DOXLEDZ42-OB*	61	DSTLEDZ30-ABMB*	67	DTLEDZ24-81*	69

Index

ITEM	PAGE	ITEM	PAGE	ITEM	PAGE	ITEM	PAGE
DTLEDZ36-51*	69	DXL24-62*	42	FN175-NB/SB*	133	GEO206*	153
DTLEDZ36-52*	69	DXL24-71*	42	FR700-OB	129	GEO209*	154
DTLEDZ36-61*	69	DXL24-91*	42	FR701-OB	129	GEO210*	155
DTLEDZ36-71*	69	DXL36-51*	42	FR750-OB	130	GEO211*	156
DTLEDZ36-81*	69	DXL36-52*	42	FR750-PN.....	130	GEO306*	153
DTRLEDZ14-AB/PB*	376	DXL36-61*	42	G100-CHB*	135	GEO309*	154
DTRLEDZ14-BLK/PN*	376	DXL36-62*	42	G100-GT*	135	GEO310*	155
DTRLEDZ14-MB/AB*	376	DXL36-71*	42	G100-WT*	135	GEO311*	156
DTRLEDZ14-SN/PN*	376	DXL36-91*	42	G200-CHB*	137	GEO411*	156
DTRLEDZ24-AB/PB*	376	DXLEDZ16-51*	65	G200-GT*	137	GP10-61*	320
DTRLEDZ24-BLK/PN*	376	DXLEDZ16-52*	65	G250-CHB*	138	GP10-7*	320
DTRLEDZ24-MB/AB*	376	DXLEDZ16-62*	65	G250-GT*	138	GP10-81*	320
DTRLEDZ24-SN/PN*	376	DXLEDZ16-71*	65	G300-BLK*	140	GP14-61*	321
DTRLEDZ36-AB/PB*	376	DXLEDZ16-91*	65	G300-CHB*	140	GP14-7*	321
DTRLEDZ36-BLK/PN*	376	DXLEDZ30-51*	65	G300-GT*	140	GP14-81*	321
DTRLEDZ36-MB/AB*	376	DXLEDZ30-52*	65	G350-BLK*	141	GPH10-BLK*	322
DTRLEDZ36-SN/PN*	376	DXLEDZ30-62*	65	G350-CHB*	141	GPH10-PB*	322
DTSLEDZ14-AB/PB*	376	DXLEDZ30-71*	65	G350-GT*	141	GPLED19-527*	323
DTSLEDZ14-BLK/PN*	376	DXLEDZ30-91*	65	G375-BLK*	142	GPLED19-61*	323
DTSLEDZ14-MB/AB*	376	DZLEDZ12-51*	71	G375-CHB*	142	GPLED19-7*	323
DTSLEDZ14-SN/PN*	376	DZLEDZ12-52*	71	G375-GT*	142	GPLED26-7*	323
DTSLEDZ14-AB/PB*	376	DZLEDZ12-62*	71	G400-ABZ*	144	GPXL22-61*	324
DTSLEDZ14-BLK/PN*	376	DZLEDZ12-71*	71	G400-BLK*	144	GPXL-617*	324
DTSLEDZ14-MB/AB*	376	DZLEDZ12-91*	71	G400-BS*	144	GR900-OB	271
DTSLEDZ14-SN/PN*	376	DZLEDZ24-51*	71	G400-GT*	144	GR901-AB	271
DTSLEDZ24-AB/PB*	376	DZLEDZ24-52*	71	G400-NB*	145	GR901-OB	271
DTSLEDZ24-BLK/PN*	376	DZLEDZ24-62*	71	G400-PG*	145	GS100-BG*	336
DTSLEDZ24-MB/AB*	376	DZLEDZ24-71*	71	G400-WT*	145	GS100-BM*	336
DTSLEDZ24-SN/PN*	376	DZLEDZ24-91*	71	G450-ABZ*	146	GS100-BR*	336
DTSLEDZ36-AB/PB*	376	DZLEDZ36-51*	71	G450-BLK*	146	GS100-CB*	336
DTSLEDZ36-BLK/PN*	376	DZLEDZ36-52*	71	G450-BS*	146	GS100-CG*	336
DTSLEDZ36-MB/AB*	376	DZLEDZ36-62*	71	G450-GT*	146	GS100-CR*	336
DTSLEDZ36-SN/PN*	376	DZLEDZ36-71*	71	G450-NB*	147	GS100-DCG*	336
DUW14-52*	47	DZLEDZ36-91*	71	G450-PG*	147	GS100-DG*	336
DUW14-62*	47	F100-AB	125	G450-WT*	147	GS100-DR*	336
DUW14-81*	47	F100-OB	125	G475-ABZ*	149	GS100-DWG*	336
DUW24-52*	47	F100-PN.....	125	G475-BLK*	148	GS100-EG*	336
DUW24-62*	47	FH300-CHB*	127	G475-GT*	148	GS100-GG*	336
DUW24-81*	47	FH301-CHB*	127	G475-PG*	149	GS100-GM*	336
DUW36-52*	47	FH350-CHB*	127	G475-WT*	148	GS100-IF*	336
DUW36-62*	47	FH375-CHB*	127	G500-ABZ*	151	GS100-KS*	336
DUW36-81*	47	FL10-MB*	329	G550-ABZ*	151	GS100-MID*	336
DXL14-51*	42	FN100-BLK/SN*	132	G575-ABZ*	151	GS100-OT*	336
DXL14-52*	42	FN100-NB/SB*	133	GEO106*	153	GS100-TE*	336
DXL14-61*	42	FN150-BLK/SN*	132	GEO109*	154	GS100-WG*	336
DXL14-62*	42	FN150-NB/SB*	133	GEO110*	155	GS100-WM*	336
DXL14-71*	42	FN175-BLK/SN*	132	GEO111*	156	GS101-BG*	337
DXL14-91*	42						
DXL24-51*	42						
DXL24-52*	42						
DXL24-61*	42						

ITEM	PAGE	ITEM	PAGE	ITEM	PAGE	ITEM	PAGE
GS101-BM*	337	GS130-GG*	343	GS160-BR*	347	GS180-WM*	349
GS101-BR*	337	GS130-GM*	343	GS160-CB*	347	GS190-BG*	350
GS101-CB*	337	GS130-IR*	343	GS160-CG*	347	GS190-BM*	350
GS101-CG*	337	GS130-MID*	343	GS160-CR*	347	GS190-BR*	350
GS101-CR*	337	GS130-OT*	343	GS160-DG*	347	GS190-CB*	350
GS101-DCG*	337	GS130-TE*	343	GS160-DR*	347	GS190-CG*	350
GS101-DG*	337	GS130-WG*	343	GS160-EG*	347	GS190-CR*	350
GS101-DR*	337	GS130-WM*	343	GS160-GG*	347	GS190-DG*	350
GS101-DWG*	337	GS140-BG*	345	GS160-IR*	347	GS190-DR*	350
GS101-EG*	337	GS140-BM*	345	GS160-MID*	347	GS190-EG*	350
GS101-GG*	337	GS140-BR*	345	GS160-OT*	347	GS190-GG*	350
GS101-GM*	337	GS140-CB*	345	GS160-TE*	347	GS190-GM*	350
GS101-IR*	337	GS140-CG*	344	GS160-WG*	347	GS190-IR*	350
GS101-KS*	337	GS140-CR*	345	GS160-WM*	347	GS190-MID*	350
GS101-MID*	337	GS140-DCG*	345	GS170-BG*	348	GS190-OT*	350
GS101-OT*	337	GS140-DG*	345	GS170-BM*	348	GS190-TE*	350
GS101-TE*	337	GS140-DR*	345	GS170-BR*	348	GS190-WG*	350
GS101-WG*	337	GS140-DWG*	345	GS170-CB*	348	GS190-WM*	350
GS101-WM*	337	GS140-EG*	345	GS170-CG*	348	GS200-BG*	353
GS110-DWM*	340	GS140-GG*	345	GS170-CR*	348	GS200-BM*	353
GS110-GG*	340	GS140-GM*	345	GS170-DG*	348	GS200-BR*	353
GS120-BG*	342	GS140-IR*	345	GS170-DR*	348	GS200-CB*	353
GS120-BM*	341	GS140-MID*	345	GS170-EG*	348	GS200-CG*	353
GS120-BR*	342	GS140-OT*	345	GS170-GG*	348	GS200-CR*	353
GS120-CB*	342	GS140-TE*	345	GS170-GM*	348	GS200-DG*	353
GS120-CG*	342	GS140-WM*	345	GS170-IR*	348	GS200-DR*	353
GS120-CR*	342	GS150-BG*	346	GS170-MID*	348	GS200-EG*	353
GS120-DG*	342	GS150-BM*	346	GS170-OT*	348	GS200-GG*	353
GS120-DR*	342	GS150-BR*	346	GS170-TE*	348	GS200-GM*	353
GS120-EG*	342	GS150-CB*	346	GS170-WG*	348	GS200-IR*	353
GS120-GG*	342	GS150-CG*	346	GS170-WM*	348	GS200-MID*	353
GS120-GM*	342	GS150-CR*	346	GS180-BG*	349	GS200-OT*	353
GS120-IR*	342	GS150-DCG*	346	GS180-BM*	349	GS200-SBG*	352
GS120-MID*	342	GS150-DG*	346	GS180-BR*	349	GS200-SBR*	352
GS120-OT*	342	GS150-DR*	346	GS180-CB*	349	GS200-TE*	353
GS120-TE*	342	GS150-DWG*	346	GS180-CG*	349	GS200-WG*	353
GS120-WG*	342	GS150-EG*	346	GS180-CR*	349	GS200-WM*	351
GS120-WM*	342	GS150-GG*	346	GS180-DG*	349	GS201-BG*	354
GS130-BG*	343	GS150-GM*	346	GS180-DR*	349	GS201-BM*	354
GS130-BM*	343	GS150-IR*	346	GS180-EG*	349	GS201-BR*	354
GS130-BR*	343	GS150-MID*	346	GS180-GG*	349	GS201-CB*	354
GS130-CB*	343	GS150-OT*	346	GS180-GM*	349	GS201-CG*	354
GS130-CG*	343	GS150-TE*	346	GS180-IR*	349	GS201-CR*	354
GS130-CR*	343	GS150-WG*	346	GS180-MID*	349	GS201-DG*	354
GS130-DG*	343	GS150-WM*	346	GS180-OT*	349	GS201-DR*	354
GS130-DR*	343	GS160-BG*	347	GS180-TE*	349	GS201-EG*	354
GS130-EG*	343	GS160-BM*	347	GS180-WG*	349	GS201-GG*	354

Index

ITEM	PAGE	ITEM	PAGE	ITEM	PAGE	ITEM	PAGE
GS201-GM*	354	GS300-WM*	356	GS400-EG*	359	GS402-WG*	362
GS201-IR*	354	GS301-BG*	357	GS400-GG*	359	GS402-WM*	362
GS201-MID*	354	GS301-BM*	357	GS400-GM*	359	GS50-BG*	335
GS201-OT*	354	GS301-BR*	357	GS400-IR*	359	GS50-BM*	335
GS201-SBG*	354	GS301-CB*	357	GS400-MID*	359	GS50-BR*	335
GS201-SBR*	354	GS301-CG*	357	GS400-OT*	359	GS50-CB*	335
GS201-TE*	354	GS301-CR*	357	GS400-SBG*	359	GS50-CG*	335
GS201-WG*	354	GS301-DG*	357	GS400-SBR*	359	GS50-CR*	335
GS201-WM*	354	GS301-DR*	357	GS400-TE*	359	GS50-DG*	335
GS202-BG*	355	GS301-EG*	357	GS400-WG*	359	GS50-DR*	335
GS202-BM*	355	GS301-GG*	357	GS400-WM*	359	GS50-EG*	335
GS202-BR*	355	GS301-GM*	357	GS401-BG*	360	GS50-GG*	335
GS202-CB*	355	GS301-IR*	357	GS401-BM*	360	GS50-GM*	335
GS202-CG*	355	GS301-MID*	357	GS401-BR*	360	GS50-IR*	335
GS202-CR*	355	GS301-OT*	357	GS401-CB*	360	GS50-MID*	335
GS202-DG*	355	GS301-SBG*	357	GS401-CG*	360	GS50-OT*	335
GS202-DR*	355	GS301-SBR*	357	GS401-CR*	360	GS50-TE*	335
GS202-EG*	355	GS301-TE*	357	GS401-DG*	360	GS50-WG*	335
GS202-GG*	355	GS301-WG*	357	GS401-DR*	360	GS50-WM*	335
GS202-GM*	355	GS301-WM*	357	GS401-EG*	360	GS600-BG*	363
GS202-IR*	355	GS302-BG*	358	GS401-GG*	360	GS600-BM*	363
GS202-MID*	355	GS302-BM*	358	GS401-GM*	360	GS600-BR*	363
GS202-OT*	355	GS302-BR*	358	GS401-IR*	360	GS600-CB*	363
GS202-SBG*	355	GS302-CB*	358	GS401-MID*	360	GS600-CG*	363
GS202-SBR*	355	GS302-CG*	358	GS401-OT*	360	GS600-CR*	363
GS202-TE*	355	GS302-CR*	358	GS401-SBG*	360	GS600-DG*	363
GS202-WG*	355	GS302-DG*	358	GS401-SBR*	360	GS600-DR*	363
GS202-WM*	355	GS302-DR*	358	GS401-TE*	360	GS600-EG*	363
GS300-BG*	356	GS302-EG*	358	GS401-WG*	360	GS600-GG*	363
GS300-BM*	356	GS302-GG*	358	GS401-WM*	360	GS600-GM*	363
GS300-BR*	356	GS302-GM*	358	GS402-BG*	362	GS600-IR*	363
GS300-CB*	356	GS302-IR*	358	GS402-BM*	362	GS600-MID*	363
GS300-CG*	356	GS302-MID*	358	GS402-BR*	362	GS600-OT*	363
GS300-CR*	356	GS302-OT*	358	GS402-CB*	362	GS600-TE*	363
GS300-DG*	356	GS302-SBG*	358	GS402-CG*	362	GS600-WG*	363
GS300-DR*	356	GS302-SBR*	358	GS402-CR*	361	GS600-WM*	363
GS300-EG*	356	GS302-TE*	358	GS402-DG*	362	GS700-BG*	365
GS300-GG*	356	GS302-WG*	358	GS402-DR*	362	GS700-BM*	364
GS300-GM*	356	GS302-WM*	358	GS402-EG*	362	GS700-BR*	365
GS300-IR*	356	GS400-BG*	359	GS402-GG*	362	GS700-CB*	365
GS300-MID*	356	GS400-BM*	359	GS402-GM*	362	GS700-CG*	365
GS300-OT*	356	GS400-BR*	359	GS402-IR*	362	GS700-CR*	365
GS300-SBG*	356	GS400-CB*	359	GS402-MID*	362	GS700-DG*	365
GS300-SBR*	356	GS400-CG*	359	GS402-OT*	362	GS700-DR*	365
GS300-SD*	356	GS400-CR*	359	GS402-SBG*	362	GS700-EG*	365
GS300-TE*	356	GS400-DG*	359	GS402-SBR*	362	GS700-GG*	365
GS300-WG*	356	GS400-DR*	359	GS402-TE*	362	GS700-GM*	365

ITEM	PAGE	ITEM	PAGE	ITEM	PAGE	ITEM	PAGE
GS700-IR*	365	GS801-MID*	367	HLEDZ26-51*	21	K100-WT*	183
GS700-MID*	365	GS801-OT*	367	HLEDZ26-52*	21	K130-BLK*	184
GS700-OT*	365	GS801-TE*	367	HLEDZ26-62*	21	K130-GR*	184
GS700-TE*	365	GS801-WG*	367	HLEDZ26-71*	21	K130-WT*	184
GS700-WG*	365	GS801-WM*	367	HLEDZ26-91*	21	K150-BLK*	185
GS700-WM*	365	GS802-BG*	368	HLEDZ600-ABZ*	166	K150-GR*	185
GS725-BG*	371	GS802-BM*	368	HLEDZ600-GT*	166	K150-PK*	186
GS725-BR*	371	GS802-BR*	368	HLEDZ650-ABZ*	166	K150-TL*	185
GS725-GM*	371	GS802-CB*	368	HLEDZ650-GT*	166	K150-WT*	186
GS725-OT*	371	GS802-CG*	368	HP8-61*	10	K175-BLK*	187
GS775-2-ABOT*	373	GS802-CR*	368	HP8-71*	10	K175-GR*	187
GS775-2-SNBG*	373	GS802-DG*	368	HP8-76*	10	K175-WT*	187
GS775-2-SNBM*	373	GS802-DR*	368	HP8-91*	10	KL300-BB*	178
GS775-2-SNGG*	373	GS802-EG*	368	HP16-61*	10	KL300-BLK*	178
GS775-ABOT*	372	GS802-EG*	368	HP16-71*	10	KL302-BB*	179
GS775-SNBG*	372	GS802-GG*	368	HP16-76*	10	KL302-BLK*	179
GS775-SNBM*	372	GS802-GM*	368	HP16-91*	10	KL325-BB*	181
GS775-SNGG*	372	GS802-IR*	368	HP30-61*	10	KL325-BLK*	181
GS800-BG*	366	GS802-MID*	368	HP30-71*	10	KL350-BB*	180
GS800-BM*	366	GS802-OT*	368	HP30-76*	10	KL350-BLK*	180
GS800-BR*	366	GS802-TE*	368	HP30-91*	10	L10-61*	330
GS800-CB*	366	GS802-WG*	368	HP700-OB-BP*	168	L300-AZSB*	192
GS800-CG*	366	GS802-WM*	368	HP700-OB-MSOB*	168	L300-BLKS*	192
GS800-CR*	366	GS850-BG*	370	HP700-OB-WL*	168	L300-MTSN*	192
GS800-DG*	366	GS850-BR*	370	HP700-WB-BP*	169	L300-ORSB*	192
GS800-DR*	366	GS850-CB*	370	HP700-WB-MSWB*	169	L300-WTSN*	192
GS800-EG*	366	GS850-CG*	370	HP700-WB-WL*	169	L325-AZSB*	193
GS800-GG*	366	GS850-CR*	370	HP725-OB-BP*	170	L325-BLKS*	193
GS800-GM*	366	GS850-DCG*	370	HP725-OB-MSOB*	170	L325-MTSN*	193
GS800-IR*	366	GS850-DG*	370	HP725-OB-WL*	170	L325-ORSB*	193
GS800-MID*	366	GS850-DR*	370	HP725-WB-BP*	171	L325-WTSN*	193
GS800-OT*	366	GS850-DWG*	370	HP725-WB-MSWB*	171	L350-AZSB*	194
GS800-TE*	366	GS850-EG*	370	HP725-WB-WL*	171	L350-BLKS*	194
GS800-WG*	366	GS850-GG*	370	HP750-OB-BP*	172	L350-MTSN*	194
GS800-WM*	366	GS850-GM*	370	HP750-OB-MSOB*	172	L350-ORSB*	194
GS801-BG*	367	GS850-KS*	369	HP750-OB-WL*	172	L375-AZSB*	195
GS801-BM*	367	GS850-MID*	370	HP750-WB-BP*	173	L375-BLKS*	195
GS801-BR*	367	GS850-OT*	370	HP750-WB-MSWB*	173	L375-MTSN*	195
GS801-CB*	367	GS850-TE*	370	HP750-WB-WL*	173	L375-ORSB*	195
GS801-CG*	367	GS850-WG*	370	JLED500-BLK*	175	L375-WTSN*	195
GS801-CR*	367	GS850-WM*	370	JLED500-CHB*	175	L800-AB	189
GS801-DG*	367	GSB105-BM*	339	JLED500-GT*	175	L800-BLK	189
GS801-DR*	367	GSB105-SD*	339	JLED550-BLK*	176	L800-OB	189
GS801-EG*	367	HLEDZ12-51*	21	JLED550-CHB*	176	L800-SN	189
GS801-GG*	367	HLEDZ12-52*	21	JLED550-GT*	176	L850-AB	190
GS801-GM*	367	HLEDZ12-62*	21	K100-BLK*	183	L850-BLK	190
GS801-IR*	367	HLEDZ12-71*	21	K100-GR*	183		
		HLEDZ12-91*	21				

Index

ITEM	PAGE	ITEM	PAGE	ITEM	PAGE	ITEM	PAGE
L850-OB.....	190	N606-AB	209	OT650-OB-WT.....	221	P14-250*	315
L850-SN.....	190	N606-OB	209	OT675-AB-AM	222	P14-250-617*.....	315
LABLED7-7*.....	330	N650-AB	210	OT675-AB-GR	222	P14-280*	312
LABLED7-71*.....	330	N650-OB.....	210	OT675-AB-MS	222	P14-280-WB*.....	312
LEW800-BLK*.....	191	N651-AB	211	OT675-AB-WT	222	P15-83-52.....	312
LEW850-BLK*.....	191	N651-OB.....	211	OT675-OB-AM.....	222	P16-D02-617*	317
LEW875-BLK*.....	191	N651-PTR.....	211	OT675-OB-GR.....	222	P16-D02-627*	317
LL660-AB	283	N652-OB.....	210	OT675-OB-MS.....	222	PFL-527*	329
LL660-OB.....	283	NEW200-AB*.....	201	OT675-OB-WT.....	222	PFL-617*	329
LL660-PB	283	NEW200-BLK*.....	201	OT675-SN-AM.....	222	PFLED-527*.....	329
LLED30-AB*.....	57	NEW200-SN*.....	201	OT675-SN-GR.....	222	PFLED-617*.....	329
LLED30-OB*	57	NEW250-AB*.....	202	OT675-SN-MS.....	222	PH100-51-F.....	158
LLED30-SN*	57	NEW250-BLK*.....	202	OT675-SN-WT.....	222	PH100-51-J.....	159
LS206-AB*.....	272	NEW250-SN*.....	202	P10-101-B*	304	PH100-52-F.....	158
LS206-MB*.....	272	NEW275-AB*.....	203	P10-111*.....	304	PH100-52-J.....	159
LS206-SP*.....	272	NEW275-BLK*.....	203	P10-111-71*.....	304	PH100-71-F.....	158
LS217-AB*.....	273	NEW275-SN*.....	203	P10-111-MB*	304	PH100-71-J.....	159
LS217-MB*.....	273	NOR300-CHBAB*.....	213	P10-130*.....	305	PH100-91-F.....	158
LS217-SP*.....	273	NOR300-GTSN*.....	213	P10-131-61*.....	305	PH100-91-J.....	159
M600-BLKAB.....	196	NOR350-CHBAB*.....	214	P10-131-71*.....	305	PH10-170-PB*.....	315
M601-BLKAB.....	196	NOR350-GTSN*.....	214	P10-150*.....	315	PH10-195-AB*.....	328
MA14-AB*.....	330	NOR375-CHBAB*.....	215	P10-150-617*.....	315	PH10-195-OB*.....	328
MA14-B*.....	330	NOR375-GTSN*.....	215	P10-190-M*.....	325	PH10-195-PB*.....	328
MA14-MB*.....	330	OR700-BLKSN*	217	P10-191-61*.....	326	PIN400-AB*	225
MO200-AB*	198	OR700-WTWB*.....	217	P10-191-61M*.....	325	PIN400-OB*	225
MO200-OB*.....	198	OR750-BLKSN*	218	P10-191-71*.....	326	PIN400-SN*	225
MO200-SN*.....	198	OR750-WTWB*.....	218	P10-191-81*.....	326	PIN450-AB*	226
MO250-AB*.....	199	OR775-BLKSN*.....	218	P10-192-617*.....	327	PIN450-OB*.....	226
MO250-OB*.....	199	OR775-WTWB*.....	218	P10-192-627*.....	327	PIN450-SN*.....	226
MO250-SN*.....	199	OT600-AB-AM	220	P14-201*.....	306	PIN475-AB*	227
MO275-AB*	200	OT600-AB-GR	220	P14-201-81*.....	306	PIN475-OB*.....	227
MO275-OB*.....	200	OT600-AB-MS	220	P14-201-AB*.....	306	PIN475-SN*.....	227
MO275-SN*.....	200	OT600-AB-WT	220	P14-201-GT*.....	306	PL16-OB*	37
N600-AB	205	OT600-SN-AM.....	220	P14-202*.....	307	PL16-WB*.....	37
N600-AB-O.....	205	OT600-SN-GR.....	220	P14-202-81*.....	307	PL20-OB*	282
N600-OB.....	205	OT600-SN-MS.....	220	P14-202-AB*.....	307	PL20-WB*.....	282
N600-OB-O.....	205	OT600-SN-WT.....	220	P14-203*.....	308	PLED100-527*.....	318
N601-AB	206	OT625-AB	223	P14-203-81*.....	308	PLED100-61*.....	318
N601-OB.....	206	OT625-OB.....	223	P14-203-AB*.....	308	PLED100-617*.....	318
N601-PTR.....	206	OT625-SN	223	P14-204*.....	309	PLED101-527*.....	316
N602-AB	207	OT650-AB-AM	221	P14-204-81*.....	309	PLED101-61*.....	316
N602-OB.....	207	OT650-AB-GR	221	P14-204-AB*.....	309	PLED101-617*.....	316
N603-AB	208	OT650-AB-MS	221	P14-231-61*.....	310	PLED192-617*.....	327
N603-OB.....	208	OT650-AB-WT	221	P14-231-71*.....	310	PLED192-627*.....	327
N603-PTR.....	208	OT650-OB-AM.....	221	P14-232-C71*.....	310	PS10-190-M*.....	325
N604-AB	209	OT650-OB-GR.....	221	P14-233-617*.....	311	R401-AB.....	234
N604-OB.....	209	OT650-OB-MS.....	221	P14-233-C71*	311	R450-AB.....	234

ITEM	PAGE	ITEM	PAGE	ITEM	PAGE	ITEM	PAGE
R450-OB	234	SL6-9*	13	SL64-51*	13	T4-71*	17
RA300-AB	229	SL6-91*	13	SL64-52*	13	T4-76*	17
RA300-OB	229	SL11-51*	13	SL64-61*	13	T4-81*	17
RA301-AB	230	SL11-52*	13	SL64-62*	13	T5-1*	17
RA301-OB	230	SL11-61*	13	SL64-7*	13	T5-31*	17
RA302-AB	231	SL11-62*	13	SL64-71*	13	T5-5*	17
RA302-OB	231	SL11-7*	13	SL64-76*	13	T5-7*	17
RA350-AB	232	SL11-71*	13	SL64-9*	13	T5-51*	17
RA350-OB	232	SL11-76*	13	SL64-91*	13	T5-52*	17
RN300-AB/SB*	236	SL11-9*	13	SL84-51*	13	T5-56*	17
RN300-BLK/PB*	236	SL11-91*	13	SL84-52*	13	T5-61*	17
RN301-AB/SB*	237	SL16-51*	13	SL84-61*	13	T5-71*	17
RN301-BLK/AB*	237	SL16-52*	13	SL84-62*	13	T5-76*	17
RN302-SN*	238	SL16-61*	13	SL84-7*	13	T5-81*	17
RR5-1*	11	SL16-62*	13	SL84-71*	13	T8-1*	17
RR8-1*	11	SL16-7*	13	SL84-76*	13	T8-1-CA*	17
RR14-1*	11	SL16-71*	13	SL84-9*	13	T8-31*	17
RR24-1*	11	SL16-76*	13	SL84-91*	13	T8-31-CA*	17
RR30-1*	11	SL16-9*	13	SLEDZ15-51*	23	T8-5*	17
RU703-BLK*	240	SL16-91*	13	SLEDZ15-52*	23	T8-5-CA*	17
RU703-CHB*	240	SL21-51*	13	SLEDZ15-61*	23	T8-7*	17
RU703-GT*	241	SL21-52*	13	SLEDZ15-71*	23	T8-7-CA*	17
RU703-WT*	241	SL21-61*	13	SLEDZ15-91*	23	T8-51*	17
RU750-BLK*	242	SL21-62*	13	SLEDZ29-51*	23	T8-51-CA*	17
RU750-CHB*	242	SL21-7*	13	SLEDZ29-52*	23	T8-52*	17
RU750-GT*	242	SL21-71*	13	SLEDZ29-61*	23	T8-52-CA*	17
RU750-WT*	242	SL21-76*	13	SLEDZ29-71*	23	T8-56*	17
RU751-GT*	243	SL21-9*	13	SLEDZ29-91*	23	T8-56-CA*	17
RU751-WT*	243	SL21-91*	13	SLEDZ43-51*	23	T8-61*	17
RU752-BLK*	243	SL30-51*	13	SLEDZ43-52*	23	T8-61-CA*	17
RU752-CHB*	243	SL30-52*	13	SLEDZ43-61*	23	T8-71*	17
S500-BLKS*	244	SL30-61*	13	SLEDZ43-71*	23	T8-71-CA*	17
S500-CHBAB*	244	SL30-62*	13	SLEDZ43-91*	23	T8-76*	17
S500-COS*	244	SL30-7*	13	SP510-52	331	T8-76-CA*	17
S550-BLKS*	245	SL30-71*	13	SP510-7	331	T8-81*	17
S550-CHBAB*	245	SL30-76*	13	SP510-9	331	T8-81-CA*	17
S550-COS*	245	SL30-9*	13	ST600-GT*	248	T9-1*	17
S575-BLKS*	246	SL30-91*	13	ST650-GT*	248	T9-1-CA*	17
S575-CHBAB*	246	SL40-51*	13	ST675-GT*	248	T9-31*	17
S575-COS*	246	SL40-52*	13	T4-1*	17	T9-31-CA*	17
SL6-51*	13	SL40-61*	13	T4-31*	17	T9-5*	17
SL6-52*	13	SL40-62*	13	T4-5*	17	T9-5-CA*	17
SL6-61*	13	SL40-7*	13	T4-7*	17	T9-7*	17
SL6-62*	13	SL40-71*	13	T4-51*	17	T9-7-CA*	17
SL6-7*	13	SL40-76*	13	T4-52*	17	T9-51*	17
SL6-71*	13	SL40-9*	13	T4-56*	17	T9-51-CA*	17
SL6-76*	13	SL40-91*	13	T4-61*	17	T9-52*	17

Index

ITEM	PAGE	ITEM	PAGE	ITEM	PAGE	ITEM	PAGE
T9-52-CA*	17	T18-61*	17	T24-71-CA*	17	TB14-SN/PN*	376
T9-56*	17	T18-61-CA*	17	T24-76*	17	TB24-AB/PB*	376
T9-56-CA*	17	T18-71*	17	T24-76-CA*	17	TB24-BLK/PN*	376
T9-61*	17	T18-71-CA*	17	T24-81*	17	TB24-MB/AB*	376
T9-61-CA*	17	T18-76*	17	T24-81-CA*	17	TB24-SN/PN*	376
T9-71*	17	T18-76-CA*	17	T30-1*	17	TB36-AB/PB*	376
T9-71-CA*	17	T18-81*	17	T30-31*	17	TB36-BLK/PN*	376
T9-76*	17	T18-81-CA*	17	T30-5*	17	TB36-MB/AB*	376
T9-76-CA*	17	T21-1*	17	T30-7*	17	TB36-SN/PN*	376
T9-81*	17	T21-1-CA*	17	T30-51*	17	TH700-OB	252
T9-81-CA*	17	T21-31*	17	T30-52*	17	TH700-PN	252
T14-1*	17	T21-31-CA*	17	T30-56*	17	TH700-RB	252
T14-1-CA*	17	T21-5*	17	T30-61*	17	TH701-OB	253
T14-31*	17	T21-5-CA*	17	T30-71*	17	TH701-RB	253
T14-31-CA*	17	T21-7*	17	T30-76*	17	TH725-OB	254
T14-5*	17	T21-7-CA*	17	T30-81*	17	TH725-PN	254
T14-5-CA*	17	T21-51*	17	T36-1*	17	TH750-OB	255
T14-7*	17	T21-51-CA*	17	T36-31*	17	TH750-PN	255
T14-7-CA*	17	T21-52*	17	T36-5*	17	TH751-OB	256
T14-51*	17	T21-52-CA*	17	T36-7*	17	TH751-RB	256
T14-51-CA*	17	T21-56*	17	T36-51*	17	TLEDZ14-1*	25
T14-52*	17	T21-56-CA*	17	T36-52*	17	TLEDZ14-31*	25
T14-52-CA*	17	T21-61*	17	T36-56*	17	TLEDZ14-5*	25
T14-56*	17	T21-61-CA*	17	T36-61*	17	TLEDZ14-51*	25
T14-56-CA*	17	T21-71*	17	T36-71*	17	TLEDZ14-52*	25
T14-61*	17	T21-71-CA*	17	T36-76*	17	TLEDZ14-56*	25
T14-61-CA*	17	T21-76*	17	T36-81*	17	TLEDZ14-61*	25
T14-71*	17	T21-76-CA*	17	T42-1*	17	TLEDZ14-71*	25
T14-71-CA*	17	T21-81*	17	T42-31*	17	TLEDZ14-76*	25
T14-76*	17	T21-81-CA*	17	T42-5*	17	TLEDZ14-81*	25
T14-76-CA*	17	T24-1*	17	T42-7*	17	TLEDZ24-1*	25
T14-81*	17	T24-1-CA*	17	T42-51*	17	TLEDZ24-31*	25
T14-81-CA*	17	T24-31*	17	T42-52*	17	TLEDZ24-5*	25
T18-1*	17	T24-31-CA*	17	T42-56*	17	TLEDZ24-51*	25
T18-1-CA*	17	T24-5*	17	T42-61*	17	TLEDZ24-52*	25
T18-31*	17	T24-5-CA*	17	T42-71*	17	TLEDZ24-56*	25
T18-31-CA*	17	T24-7*	17	T42-76*	17	TLEDZ24-61*	25
T18-5*	17	T24-7-CA*	17	T42-81*	17	TLEDZ24-71*	25
T18-5-CA*	17	T24-51*	17	T400-BLKSN	250	TLEDZ24-76*	25
T18-7*	17	T24-51-CA*	17	T400-BLKB	250	TLEDZ24-81*	25
T18-7-CA*	17	T24-52*	17	TB8-AB/PB*	376	TLEDZ36-1*	25
T18-51*	17	T24-52-CA*	17	TB8-BLK/PN*	376	TLEDZ36-31*	25
T18-51-CA*	17	T24-56*	17	TB8-MB/AB*	376	TLEDZ36-5*	25
T18-52*	17	T24-56-CA*	17	TB8-SN/PN*	376	TLEDZ36-51*	25
T18-52-CA*	17	T24-61*	17	TB14-AB/PB*	376	TLEDZ36-52*	25
T18-56*	17	T24-61-CA*	17	TB14-BLK/PN*	376	TLEDZ36-56*	25
T18-56-CA*	17	T24-71*	17	TB14-MB/AB*	376	TLEDZ36-61*	25

ITEM	PAGE	ITEM	PAGE	ITEM	PAGE	ITEM	PAGE
TLEDZ36-71*	25	USLEDZ15-62*	27	WL609-SN.....	275	WS751-OB.....	287
TLEDZ36-76*	25	USLEDZ15-7*	27	WL616-AB.....	276	WS752-AB.....	288
TLEDZ36-81*	25	USLEDZ15-71*	27	WL616-CB.....	276	WS752-AS.....	288
TR201-BLK.....	257	USLEDZ15-76*	27	WL616-PB.....	276	WS752-OB.....	288
TR8-AB/PB*	376	USLEDZ15-9*	27	WL625-OB.....	277	WS761-AB.....	289
TR8-BLK/PN*	376	USLEDZ15-91*	27	WL625-SN.....	277	WS761-AS.....	289
TR8-MB/AB*	376	USLEDZ28-51*	27	WL630-ABZ*	293	WS761-OB.....	289
TR8-SN/PN*	376	USLEDZ28-52*	27	WL630-SN*	293	WS775-OB.....	290
TR14-AB/PB*	376	USLEDZ28-61*	27	WL631-ABZ*	278	WS775-SN.....	290
TR14-BLK/PN*	376	USLEDZ28-62*	27	WL631-SN*	278	WS776-OB.....	291
TR14-MB/AB*	376	USLEDZ28-7*	27	WL632-ABZ*	279	WS776-PN.....	291
TR14-SN/PN*	376	USLEDZ28-71*	27	WL632-SN*	279	XL14-51*.....	15
TR24-AB/PB*	376	USLEDZ28-76*	27	WOL400-OB.....	298	XL14-52*.....	15
TR24-BLK/PN*	376	USLEDZ28-9*	27	WOL400-PN.....	298	XL14-61*.....	15
TR24-MB/AB*	376	USLEDZ28-91*	27	WS12-51-F.....	160	XL14-62*.....	15
TR24-SN/PN*	376	USLEDZ41-51*	27	WS12-51-J.....	161	XL14-71*.....	15
TR36-AB/PB*	376	USLEDZ41-52*	27	WS12-52-F.....	160	XL14-91*.....	15
TR36-BLK/PN*	376	USLEDZ41-61*	27	WS12-52-J.....	161	XL24-51*.....	15
TR36-MB/AB*	376	USLEDZ41-62*	27	WS12-71-F.....	160	XL24-52*.....	15
TR36-SN/PN*	376	USLEDZ41-7*	27	WS12-71-J.....	161	XL24-61*.....	15
TS8-AB/PB*	376	USLEDZ41-71*	27	WS12-91-F.....	160	XL24-62*.....	15
TS8-BLK/PN*	376	USLEDZ41-76*	27	WS12-91-J.....	161	XL24-71*.....	15
TS8-MB/AB*	376	USLEDZ41-9*	27	WS14-2-52.....	162	XL24-91*.....	15
TS8-SN/PN*	376	USLEDZ41-91*	27	WS14-2-71.....	162	XL36-51*.....	15
TS14-AB/PB*	376	VER500-BLK*	263	WS14-2-91.....	162	XL36-52*.....	15
TS14-BLK/PN*	376	VER500-PG*	263	WS14-51.....	163	XL36-61*.....	15
TS14-MB/AB*	376	VER500-WT*	263	WS14-52.....	163	XL36-62*.....	15
TS14-SN/PN*	376	VER502-BLK*	264	WS14-61.....	163	XL36-71*.....	15
TS24-AB/PB*	376	VER502-PG*	264	WS14-71.....	164	XL36-91*.....	15
TS24-BLK/PN*	376	VER502-WT*	264	WS14-9.....	164	ZLEDZ12-51*.....	29
TS24-MB/AB*	376	VG450-AB.....	261	WS14-91.....	164	ZLEDZ12-52*.....	29
TS24-SN/PN*	376	VIC900-BLK*	268	WS16-31.....	292	ZLEDZ12-62*.....	29
TS36-AB/PB*	376	VIC900-CT*	268	WS16-91.....	292	ZLEDZ12-71*.....	29
TS36-BLK/PN*	376	VIC925-BLK*	266	WS-704*.....	285	ZLEDZ12-91*.....	29
TS36-MB/AB*	376	VIC925-CT*	266	WS-706*.....	284	ZLEDZ24-51*.....	29
TS36-SN/PN*	376	VIC950-BLK*	267	WS-706-AB*.....	284	ZLEDZ24-52*.....	29
UP501-BLK/SN*	259	VIC950-CT*.....	267	WS-706-OB*.....	284	ZLEDZ24-62*.....	29
UP501-NB/SB*	259	W400-AB.....	295	WS-708-OB*.....	285	ZLEDZ24-71*.....	29
UP501-SB/PB*	259	W400-OB.....	295	WS720-OB.....	290	ZLEDZ24-91*.....	29
UP502-BLK/SN*	260	W401-AB.....	296	WS731-ABBLK.....	292	ZLEDZ36-51*.....	29
UP502-NB/SB*	260	W401-OB.....	296	WS750-AB.....	286	ZLEDZ36-52*.....	29
UP502-SB/PB*	260	WL601-OB.....	274	WS750-AS.....	286	ZLEDZ36-62*.....	29
USLEDZ15-51*	27	WL601-PC.....	274	WS750-OB.....	286	ZLEDZ36-71*.....	29
USLEDZ15-52*	27	WL601-SN.....	274	WS751-AB.....	287		
USLEDZ15-61*	27	WL609-SB.....	275	WS751-AS.....	287		

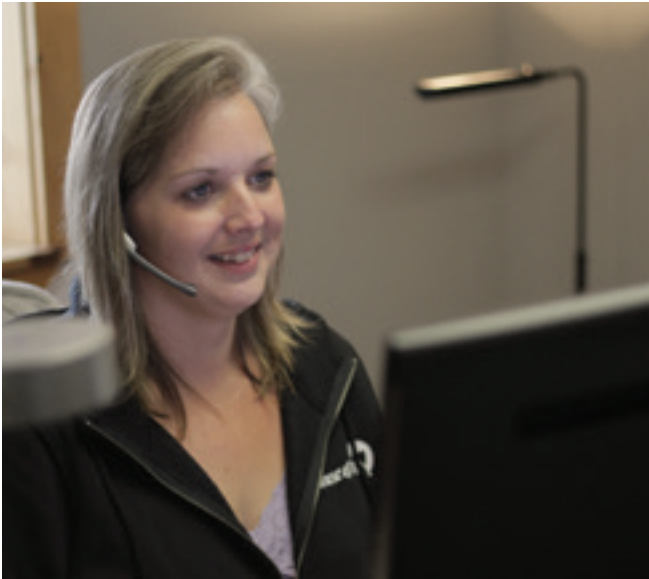
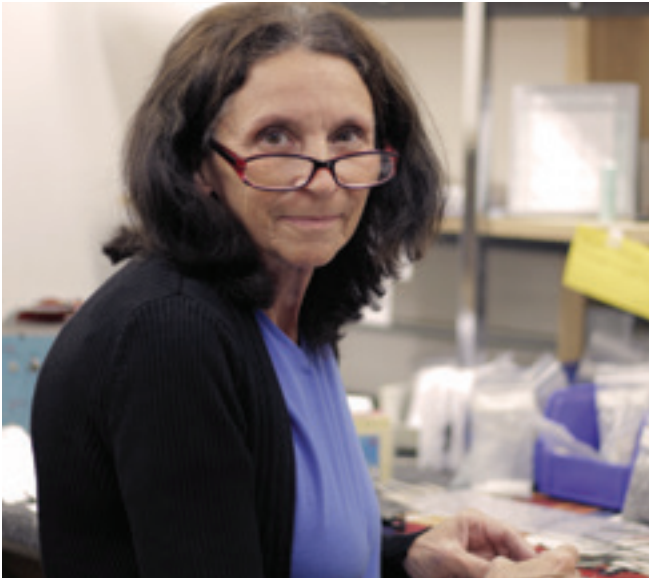

American Lighting Brands

Arroyo Craftsman • Framburg • House of Troy • Scatchard Stoneware • Thumprints



FRAMBURG



HOUSE OF TROY

Scatchard Stoneware

